

RICOH

Aficio

551/700

Operating Instructions
COPY REFERENCE

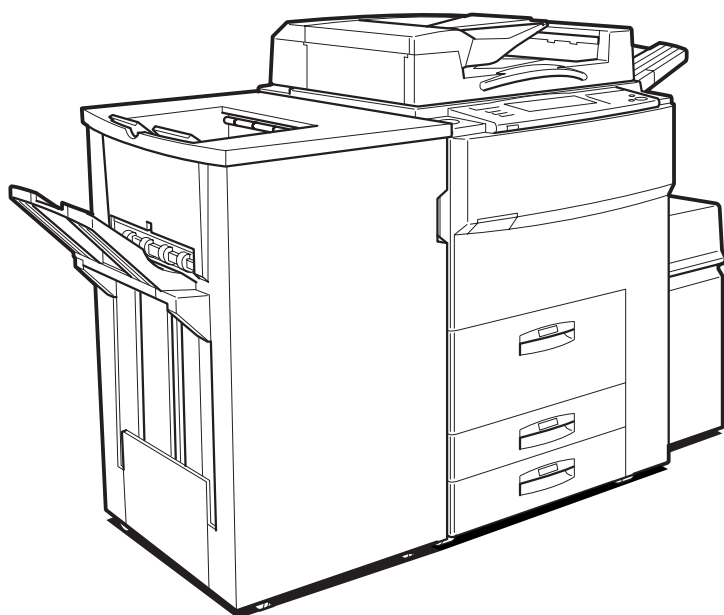

Read this manual carefully before you use this product and keep it handy for future reference.

For safety, please follow the instructions in this manual.



RICOH COMPANY, LTD.

15-5, 1 chome, Minami-Aoyama, Minato-ku, Tokyo
Telephone: Tokyo 3479-3111

Overseas Affiliates

U.S.A.

RICOH CORPORATION
5 Dedrick Place
West Caldwell, New Jersey 07006
Phone: +1-973-882-2000

The Netherlands

RICOH EUROPE B.V.
Groenelaan 3, 1186 AA, Amstelveen
Phone: +31-(0)20-5474111

United Kingdom

RICOH UK LTD.
Ricoh House,
1 Plane Tree Crescent, Feltham,
Middlesex, TW13 7HG
Phone: +44-(0)181-261-4000

Germany

RICOH DEUTSCHLAND GmbH
Mergenthalerallee 38-40,
65760 Eschborn
Phone: +49-(0)6196-9060

France

RICOH FRANCE S.A.
383, Avenue du Général de Gaulle
BP 307-92143 Clamart Cedex
Phone: +33-(0)1-40-94-38-38

Spain

RICOH ESPAÑA S.A.
Avda. Litoral Mar, 12-14,
08005 Barcelona
Phone: +34-(0)93-295-7600

Italy

RICOH ITALIA SpA
Via della Metallurgia 12,
37139 Verona
Phone: +39-045-8181500

Hong Kong

RICOH HONG KONG LTD.
23/F., China Overseas Building,
139, Hennessy Road,
Wan Chai, Hong Kong
Phone: +852-2862-2888

Singapore

RICOH ASIA PACIFIC PTE.LTD.
260 Orchard Road,
#15-01/02 The Heeren,
Singapore 238855
Phone: +65-830-5888

Introduction

This manual contains detailed instructions on the operation and maintenance of this machine. To get maximum versatility from this machine all operators should carefully read and follow the instructions in this manual. Please keep this manual in a handy place near the machine.

Please read the Safety Information before using this machine. It contains important information related to USER SAFETY and PREVENTING EQUIPMENT PROBLEMS.



Notes

Some illustrations may be slightly different from your machine.

Certain options may not be available in some countries. For details, please contact your local dealer.



Operator Safety

This machine is considered a CDRH class 1 laser device, safe for office/EDP use. The machine contains two GaAlAs laser diodes, 5-milliwatt, 760-800 nanometer wavelength for each emitter. Direct (or indirect reflected) eye contact with the laser beam might cause serious eye damage. Safety precautions and interlock mechanisms have been designed to prevent any possible laser beam exposure to the operator.

Laser Safety:

The Center for Devices and Radiological Health (CDRH) prohibits the repair of laser-based optical unit in the field. The optical housing unit can only be repaired in a factory or at a location with the requisite equipment. The laser subsystem is replaceable in the field by a qualified Customer Engineer. The laser chassis is not repairable in the field. Customer engineers are therefore directed to return all chassis and laser subsystems to the factory or service depot when replacement or the optical subsystem is required.

Warning:

Use of controls or adjustment or performance of procedures other than those specified in this manual might result in hazardous radiation exposure.

Notes:

The model names of the machines do not appear in the following pages. Check the type of your machine before reading this manual. (For details, see ⇒ P.1 "*Machine Types*".)

- Type1: Aficio 551
- Type2: Aficio 700

Certain types might not be available in some countries. For details, please contact your local dealer.

Two kinds of size notation are employed in this manual. With this machine refer to the inch version.

For good copy quality, Ricoh recommends that you use genuine Ricoh toner.

Ricoh shall not be responsible for any damage or expense that might result from the use of parts other than genuine Ricoh parts in your Ricoh office product.

Power Source

120V, 60Hz, 20A or more

Please be sure to connect the power cord to a power source as above. For details about power source, see ⇒ P.335 "*Power Connection*".

In accordance with IEC 60417, this machine uses the following symbols for the main power switch:

I means **POWER ON.**

⏻ means **STAND BY.**

Introduction

This manual contains detailed instructions on the operation and maintenance of this machine. To get maximum versatility from this machine all operators should carefully read and follow the instructions in this manual. Please keep this manual in a handy place near the machine.

Please read the Safety Information before using this machine. It contains important information related to USER SAFETY and PREVENTING EQUIPMENT PROBLEMS.



Notes

Some illustrations may be slightly different from your machine.

Certain options may not be available in some countries. For details, please contact your local dealer.



Operator Safety

This machine is considered a CDRH class 1 laser device, safe for office/EDP use. The machine contains two GaAlAs laser diodes, 5-milliwatt, 760-800 nanometer wavelength for each emitter. Direct (or indirect reflected) eye contact with the laser beam might cause serious eye damage. Safety precautions and interlock mechanisms have been designed to prevent any possible laser beam exposure to the operator.

Laser Safety:

The Center for Devices and Radiological Health (CDRH) prohibits the repair of laser-based optical unit in the field. The optical housing unit can only be repaired in a factory or at a location with the requisite equipment. The laser subsystem is replaceable in the field by a qualified Customer Engineer. The laser chassis is not repairable in the field. Customer engineers are therefore directed to return all chassis and laser subsystems to the factory or service depot when replacement or the optical subsystem is required.

Warning:

Use of controls or adjustment or performance of procedures other than those specified in this manual might result in hazardous radiation exposure.

Notes:

The model names of the machines do not appear in the following pages. Check the type of your machine before reading this manual. (For details, see ⇒ P.1 "*Machine Types*".)

- Type1: 2055DP, 3355
- Type2: 2070DP, 3370

Certain types might not be available in some countries. For details, please contact your local dealer.

Two kinds of size notation are employed in this manual. With this machine refer to the inch version.

For good copy quality, Savin recommends that you use genuine toner.

Savin shall not be responsible for any damage or expense that might result from the use of parts other than genuine parts in your office product.

Power Source

120V, 60Hz, 20A or more

Please be sure to connect the power cord to a power source as above. For details about power source, see ⇒ P.335 "*Power Connection*".

Read this manual carefully before you use this product and keep it handy for future reference.

For safety, please follow the instructions in this manual.

In accordance with IEC 60417, this machine uses the following symbols for the main power switch:

I means **POWER ON.**

⏻ means **STAND BY.**

SAVIN CORPORATION

333 Ludlow Street, Stamford, CT 06904

203-967-5000

Safety Information

When using your equipment, the following safety precautions should always be followed.

Safety During Operation

In this manual, the following important symbols are used:

⚠ WARNING:
Indicates a potentially hazardous situation which, if instructions are not followed, could result in death or serious injury.

⚠ CAUTION:
Indicates a potentially hazardous situation which, if instructions are not followed, may result in minor or moderate injury or damage to property.

⚠ WARNING:

- **Connect the power cord directly into a wall outlet and never use an extension cord.**
- **Disconnect the power plug (by pulling the plug, not the cable) if the power cable or plug becomes frayed or otherwise damaged.**
- **To avoid hazardous electric shock or laser radiation exposure, do not remove any covers or screws other than those specified in this manual.**
- **Turn off the power and disconnect the power plug (by pulling the plug, not the cable) if any of the following conditions exists:**
 - **You spill something into the equipment.**
 - **You suspect that your equipment needs service or repair.**
 - **Your equipment's cover has been damaged.**
- **Do not incinerate spilled toner or used toner. Toner dust might ignite when exposed to an open flame.**
- **Disposal can take place at our authorized dealer or at appropriate collection sites.**
- **Dispose of the used toner bottle in accordance with the local regulation.**

⚠ CAUTION:

- *Protect the equipment from dampness or wet weather, such as rain, snow, and so on.*
- *Unplug the power cord from the wall outlet before you move the equipment. While moving the equipment, you should take care that the power cord will not be damaged under the equipment.*
- *When you disconnect the power plug from the wall outlet, always pull the plug (not the cable).*
- *Do not allow paper clips, staples, or other small metallic objects to fall inside the equipment.*
- *Keep toner (used or unused) and toner bottle out of the reach of children.*
- *For environmental reasons, do not dispose of the equipment or expended supply waste at household waste collection points. Disposal can take place at an authorized dealer or at appropriate collection sites.*
- *The inside of the machine could be very hot. Do not touch the parts with a label indicating the “hot surface”. Otherwise it could cause a personal burn.*
- *Our products are engineered to meet high standards of quality and functionality, and we recommend that you only use the expendable supplies available at an authorized dealer.*

How to Read this Manual

Symbols

In this manual, the following symbols are used:

 **WARNING:**

This symbol indicates a potentially hazardous situation that might result in death or serious injury when you misuse the machine without following the instructions under this symbol. Be sure to read the instructions, all of which are included in the Safety Information section.

 **CAUTION:**

This symbol indicates a potentially hazardous situation that might result in minor or moderate injury or property damage that does not involve personal injury when you misuse the machine without following the instructions under this symbol. Be sure to read the instructions, all of which are included in the Safety Information section.

- WARNINGS and CAUTIONS are notes for your safety.

 **Important**

If this instruction is not followed, paper might be misfeed, originals might be damaged, or data might be lost. Be sure to read this.

 **Preparation**

This symbol indicates the prior knowledge or preparations required before operating.

 **Note**

This symbol indicates precautions for operation or actions to take after misoperation.

 **Limitation**

This symbol indicates numerical limits, functions that cannot be used together, or conditions in which a particular function cannot be used.

 **Reference**

This symbol indicates a reference.

[]

Keys that appear on the machine's display panel.

[]

Keys built into the machine's control panel.

TABLE OF CONTENTS

Machine Types	1
What You Can Do with This Machine (Copy Mode)	2
Guide To Components	4
Output Tray Guide.....	6
Options	7
Control Panel	8
Display Panel	10
Displays and Key Operations.....	10
Function List Based on Options	13

1. Basics

Turning On the Power	17
Turning On the Main Power.....	17
Starting the Machine.....	18
Shutting Down the Machine.....	18
Turning Off the Main Power.....	18
Originals	19
Sizes and Weights of Recommended Originals.....	19
Sizes Detectable by the Auto Paper Select.....	20
Missing Image Area.....	21
Copy Paper	23
Recommended Paper Sizes and Types.....	23
Non-recommended Paper.....	25
Paper Storage.....	26
Toner	27
Handling Toner.....	27
Toner Storage.....	27
Used Toner.....	27

2. Copying

Basic Procedure	29
Setting Originals	31
Setting Originals on the Exposure Glass.....	31
Setting Originals in the Document Feeder.....	32
Original Orientation.....	33
Setting Special Originals.....	36
Basic Functions	40
Adjusting Copy Image Density.....	40
Selecting Original Type Setting.....	42
Selecting Copy Paper.....	43

Auto Reduce/Enlarge	47
Copying onto Tab Stock.....	48
Sort/Stack/Staple	52
Sort.....	55
Stack	58
Staple	60
To Stop Scanning Temporarily.....	67
When Memory Reaches 0%	68
To Remove the Paper from the Staple Unit	68
Punch.....	69
Copying from the Bypass Tray	73
When Copying onto OHP Transparencies or Thick Paper.....	76
Programs.....	78
Storing a Program	78
Changing a Stored Program	80
Deleting a Program	80
Recalling a Program.....	81
Job Preset	83
Editing Job Preset	84
Deleting Job Preset.....	86
Other Functions.....	88
Energy Saver Mode	88
Interrupt Copy	88
User Codes	90
Auto Start	90
Original Beeper	91
Sample Copy.....	91
Changing the Number of Sets.....	92
Preset Reduce/Enlarge	94
Shrink&Center mode.....	96
Zoom.....	97
Size Magnification	99
Directional Magnification (%)	101
Directional Size Magnification (inch).....	104
Duplex/Combine	107
Original Direction and Completed Copies	109
Originals and Copy Direction	109
Specifying Orientation of Bound Originals	110
Duplex.....	111
1 Sided → 2 Sided	111
2 Sided → 2 Sided	113
Combine	115
1 Sided 2 Pages → Combine 1 Side.....	117
1 Sided 4 Pages → Combine 1 Side.....	119

1 Sided 8 Pages → Combine 1 Side.....	120
1 Sided 4 Pages → Combine 2 Side.....	122
1 Sided 8 Pages → Combine 2 Side.....	123
1 Sided 16 Pages → Combine 2 Side.....	125
2 Sided 2 Pages → Combine 1 Side.....	127
2 Sided 4 Pages → Combine 1 Side.....	128
2 Sided 8 Pages → Combine 1 Side.....	130
2 Sided 4 Pages → Combine 2 Side.....	131
2 Sided 8 Pages → Combine 2 Side.....	133
2 Sided 16 Pages → Combine 2 Side.....	135
Series/Book.....	137
Series Copies.....	138
Copying Book Originals.....	140
Cover/Slip Sheet.....	151
Front Cover	151
Front/Back Covers	154
Designate	156
Chapters.....	158
Slip Sheets	162
Double Copies	165
Image Repeat	167
Margin Adjustment.....	170
Erase.....	172
Border Erase	173
Center Erase	175
Center/Border Erase	177
Centering.....	179
Stamp.....	181
Background Numbering	181
Preset Stamp	183
User Stamp	186
Date Stamp	194
Page Numbering	198
Combination Chart	206

3. Document Server

Overview.....	209
Document Server Features	209
Features and Benefits.....	210
On Demand Printing.....	210
File Merge Printing	211
Scanning Originals.....	212

Printing Saved Documents	216
Sample Printing.....	218
Print First Page	218
To Search by File Name	219
Deleting Saved Documents	220

4. Connect Copy (Option)

What is Connect Copy?	223
How Connect Copy Works	225
Connectable Copier Models	225
Functions Not Available with Connect Copy	226
Interrupt Functions	226
Before You Start.....	226
Connect Copy Display Panel	227
Using Connect Copy	230
Exiting Connect Copy Mode.....	235
Printing Saved Documents with Connect Copy	236
Relationship Between Master Unit and Sub-Unit System Settings ...	239
Relationship Between Master Unit and Sub-Unit Copy/ Document Server Features	242

5. What to Do If Something Goes Wrong

If Your Machine Does Not Operate as You Want	247
General	247
Document Server	250
Display	251
If Connect Copy Is Cleared	254
If You Cannot Exit Connect Copy	255
If You Cannot Make Clear Copies	257
If You Cannot Make Copies As You Want	258
General	258
Adjust Image	259
Combine.....	259
Duplex.....	260
Stamp.....	261
When Memory Is Full	261
📄 Loading Paper	263
Loading Paper in Tray 1 (Tandem Tray)	263
Loading Paper in Tray 2 or 3.....	265
Loading Paper in the Large Capacity Tray.....	266
🗑️ Changing the Toner Bottle	268
🔧 Clearing Misfeeds	270

Changing the Paper Size	282
Changing the Paper Size in Tray 2	282
📌 Adding Staples	285
50-Sheet Finisher	285
100-Sheet Finisher	287
Booklet Finisher	290
🔧 Removing Jammed Staples	293
50-Sheet Finisher	293
100-Sheet Finisher	295
Booklet Finisher	298
🗑️ Removing Punch Waste	301
50-Sheet Finisher	301
100-Sheet Finisher	302

6. User Tools (Copy/Document Server Features)

Accessing the User Tools (Copy/Document Server Features)	305
Exiting From the User Tools	306
User Tools Menu (Copy/Document Server Features)	308
Settings You Can Change with the User Tools	310
General Features ¹ / ₃	310
General Features ² / ₃	313
General Features ³ / ₃	314
Reproduction Ratio ¹ / ₂	315
Reproduction Ratio ² / ₂	316
Page Format ¹ / ₂	317
Page Format ² / ₂	320
Stamp Setting	323
Input/Output	329
Count Manager	331

7. REMARKS





Do's And Don'ts	333
Where to Put Your Machine	334
Machine Environment	334
Power Connection	335
Access to the Machine	336
Maintaining Your Machine	337
Cleaning the Exposure Glass	337
Cleaning the Document Feeder	337

8. Specification

Mainframe.....	339
Document Feeder	343
50-Sheet Finisher.....	344
100-Sheet Finisher.....	346
Booklet Finisher	348
Punch Kit (Option).....	350
Output Tray (Option)	351
Large Capacity Tray (LCT) (Option).....	352
Copy Connector Cable (Option).....	353
INDEX.....	354

Machine Types

This machine comes in two models which vary in copy speed. To make sure which model you have, see the inside front cover.

	Type 1	Type 2
Copy speed	55 copies/minute (A4  , 8 ¹ / ₂ " × 11" )	70 copies/minute (A4  , 8 ¹ / ₂ " × 11" )

What You Can Do with This Machine (Copy Mode)

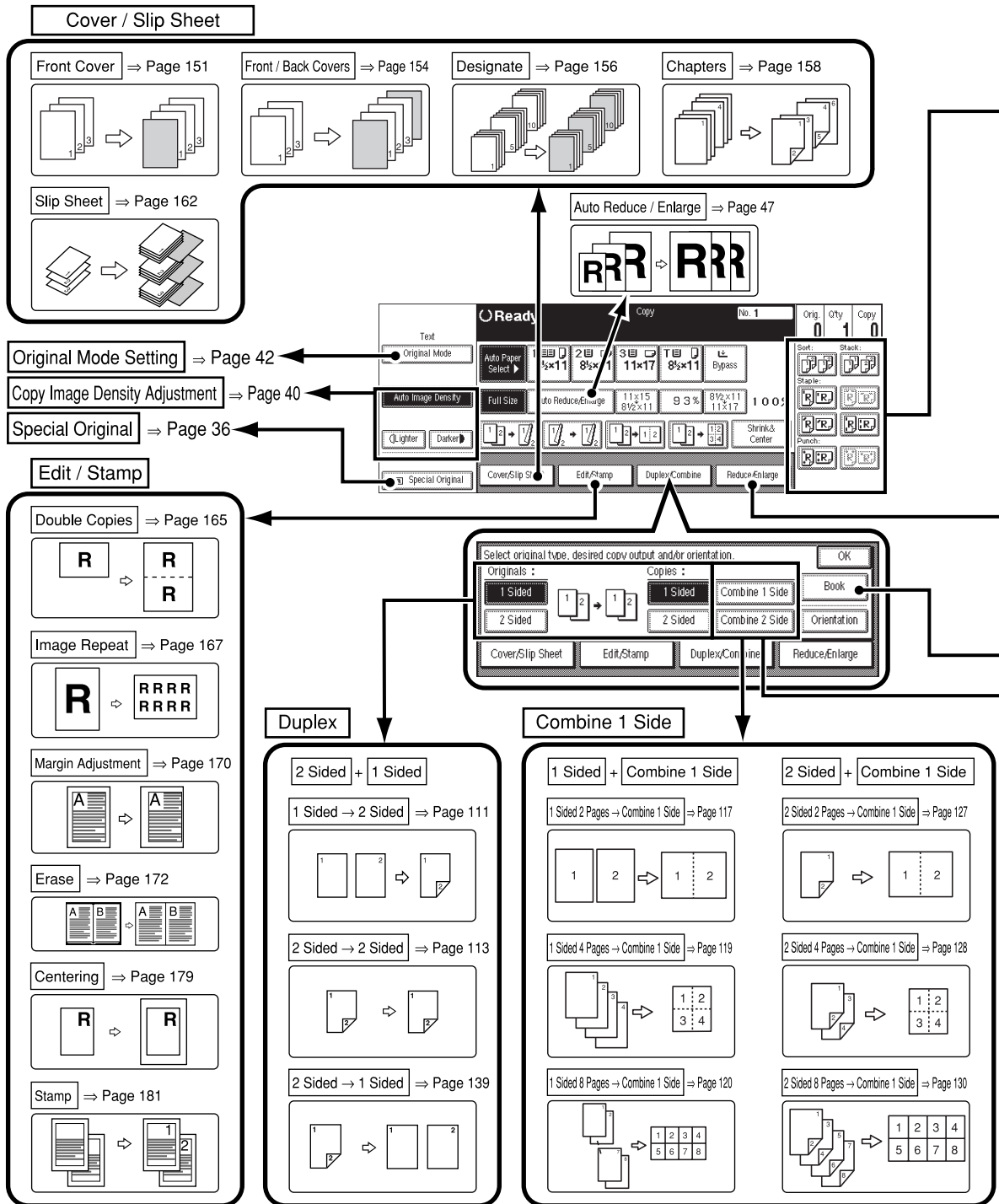

*1 Optional finisher is required.

*2 Optional finisher and punch kit are required.

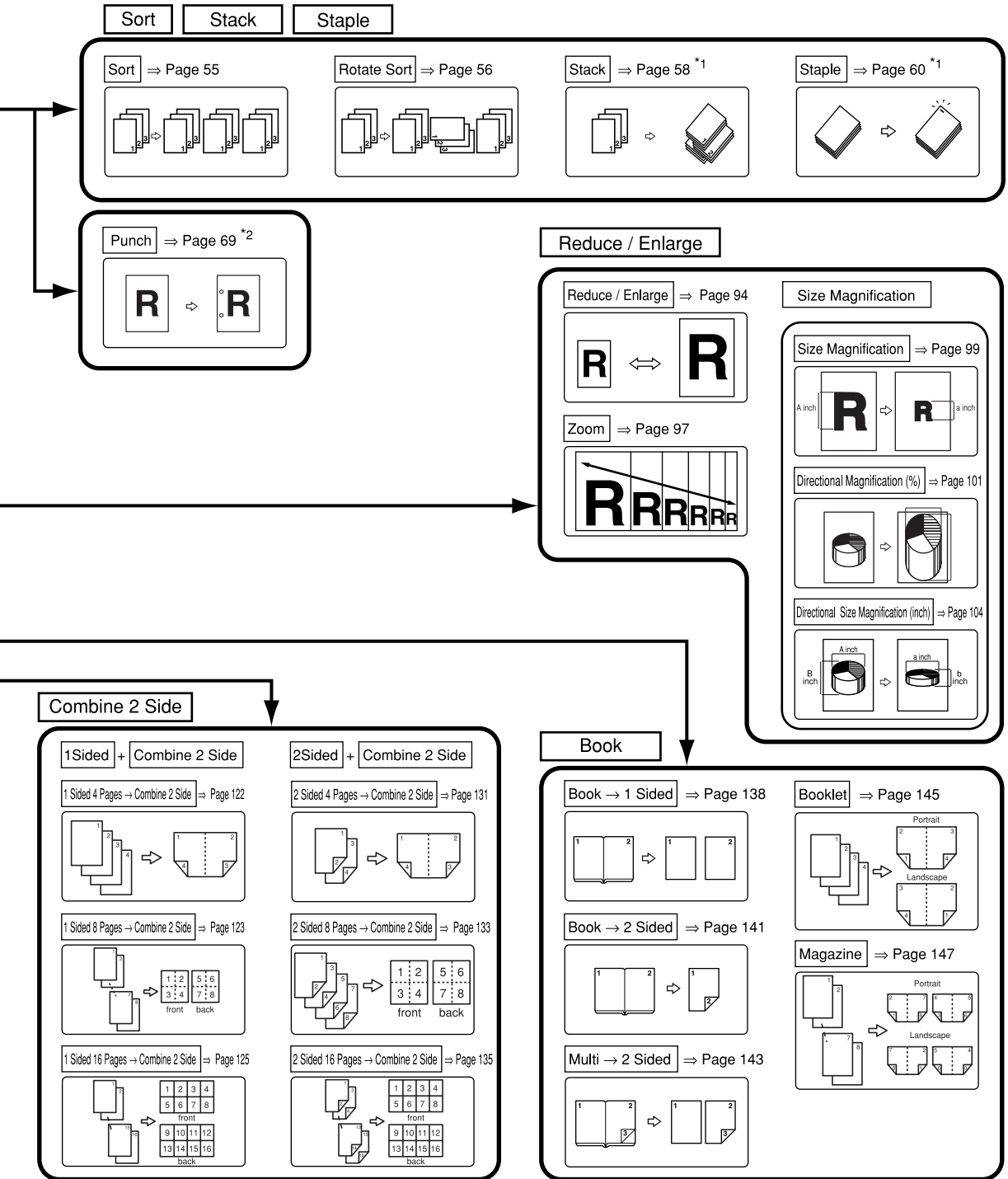

Guide To Components

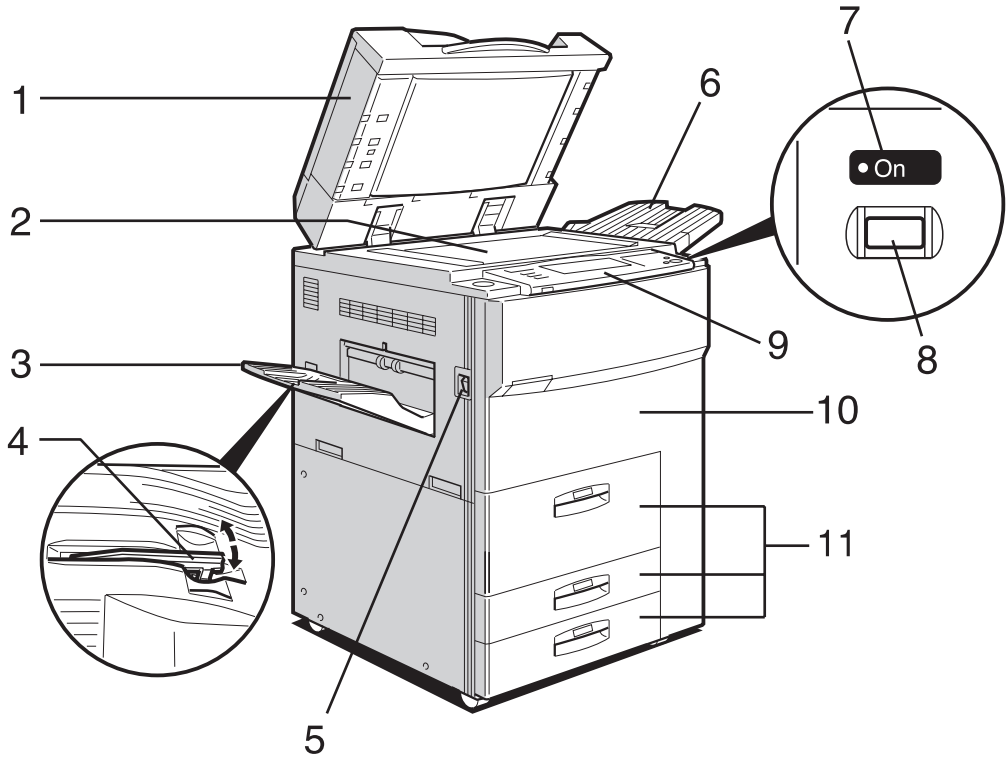

ZBQS010N

- 1. Document Feeder (ADF)**
The document feeder automatically feeds a stack of originals one by one.
- 2. Exposure glass**
Place originals here face down for copying.
- 3. Output tray**
Copied paper is delivered here.
- 4. Output tray guide**
This guide prevents copied OHP transparencies and translucent paper from being curled when delivered.
- 5. Main power switch**
If the machine does not operate after turning on the operation switch, check if the main power switch is turned on. If it is off, turn it on.
- 6. ADF external tray**
When copying one-sided originals, the originals are delivered here.

- 7. On indicator**
This indicator goes on when the operation switch is turned on, and goes off when the switch is turned off.
- 8. Operation switch**
Press this switch to turn the power on (the **On** indicator goes on). To turn the power off, press this switch again (the **On** indicator goes off).
- 9. Control panel**
See ⇒ P.8 "Control Panel".
- 10. Front cover**
Open to access the inside of the machine.
- 11. Paper tray**
Set paper here.
Tray 1 is a tandem tray where the paper on the left side automatically moves to the right side when the paper on the right side has run out.

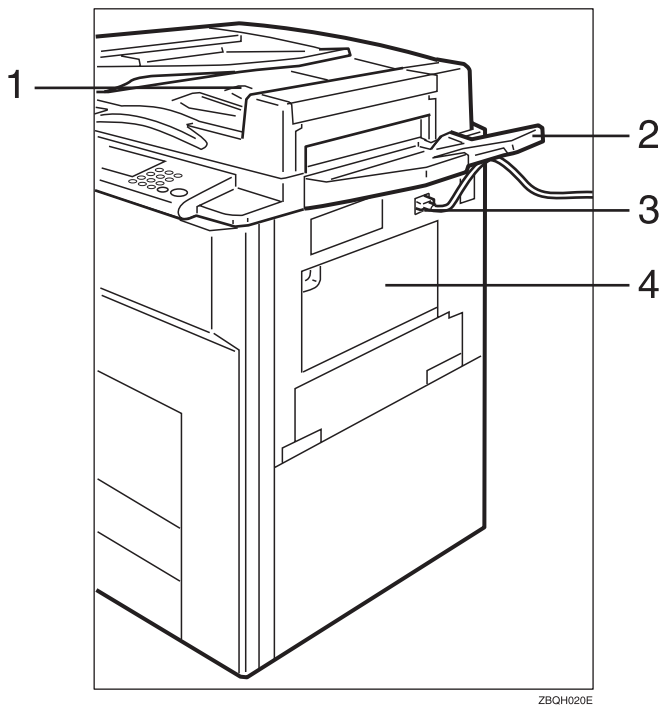

ZBQH020E

1. ADF tray

When copying two-sided originals, the originals are delivered here.

Note

- Even when copying one-sided originals, you can select the ADF tray.

2. ADF external tray

When copying one-sided originals, the originals are delivered here.

3. Connect Copy port

Attach the optional Connect Copy cable here.

Important

- Do not connect any other equipment to the Connect Copy port.
- Be sure to turn off the main power switch on both the master unit and sub-unit before you disconnect the Connect Copy cable. Unplugging the cable while power is on could damage the machines.

4. Bypass tray

Use to copy onto OHP transparencies, adhesive labels, translucent paper, post-cards, and non-standard size paper.

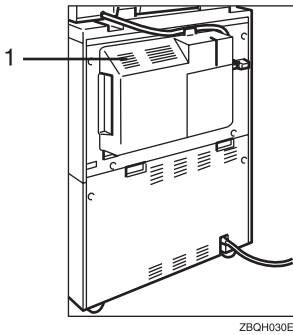

1. Ventilation hole

Prevents overheating. Do not obstruct the ventilation hole by placing or leaning an object near it. If the machine overheats, a fault might occur.

Output Tray Guide

When copying onto OHP transparencies and translucent paper, raise the guide. This prevents copies from being curled when delivered.

❖ To copy onto normal paper and thick paper

Pinch the right end of the guide, and then lower it until it clicks into place.

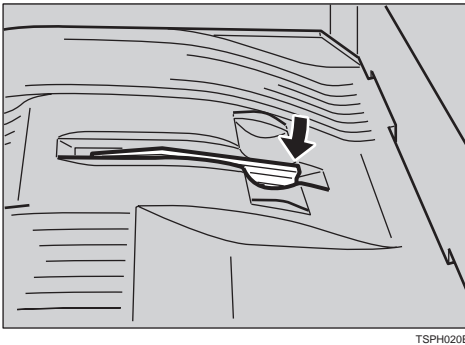

❖ To copy onto OHP transparencies and translucent paper

Raise the right end of the guide until it clicks.

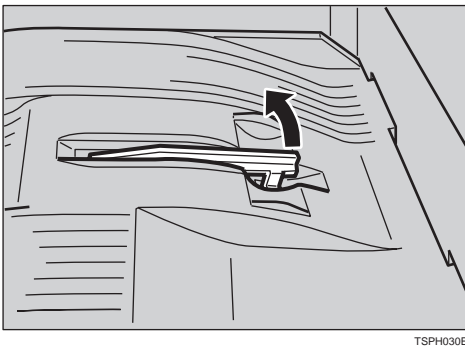

Options

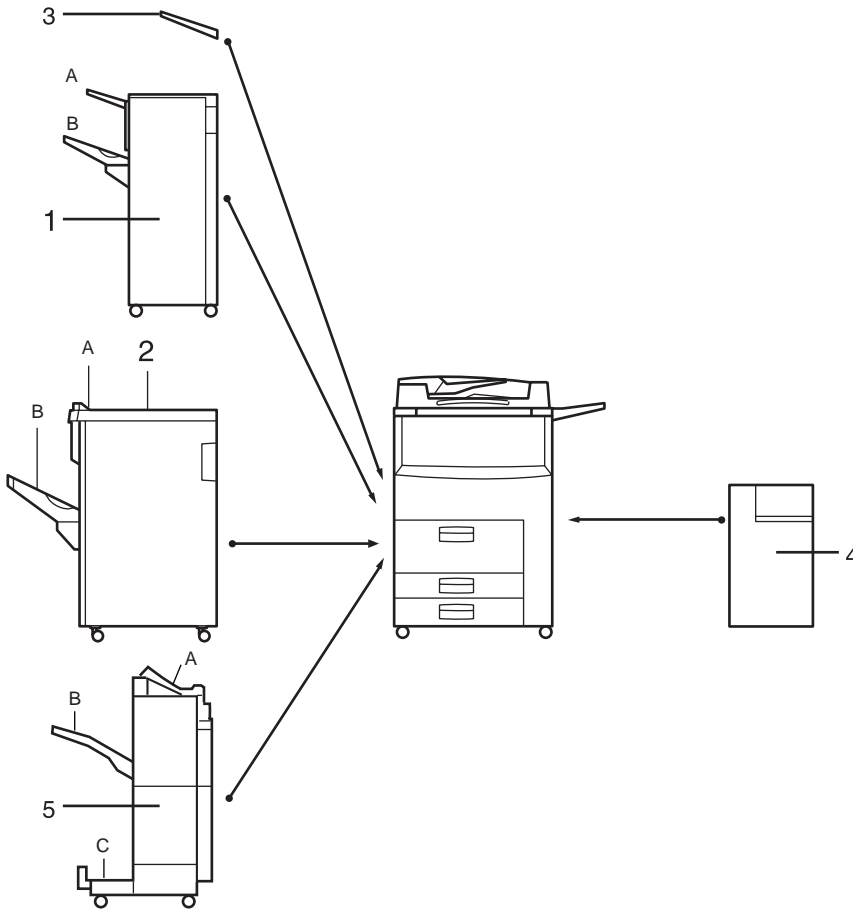

ZBQP010E

1. 50-Sheet Finisher

Sorts, stacks, and staples copies. You can also punch copies. (The Punch function is optional.)

- A: Finisher proof tray
- B: Finisher shift tray

2. 100-Sheet Finisher

Sorts, stacks, and staples copies. You can also punch copies. (The Punch function is optional.)

- A: Finisher proof tray
- B: Finisher shift tray

Other options:

- Punch kit
- Copy Connector kit
- Tab sheet tray
- 8¹/₂" × 14" paper size tray (inch version only)

3. Output tray (Can be installed when the finisher is not installed.)

Copied paper is delivered here.

4. Large Capacity Tray (LCT)

Holds 3,500 sheets of paper.

5. Booklet Finisher

Sorts, stacks, and staples copies. The Saddle Stitch function is also available.

- A: Finisher proof tray
- B: Finisher shift tray
- C: Booklet tray

Control Panel

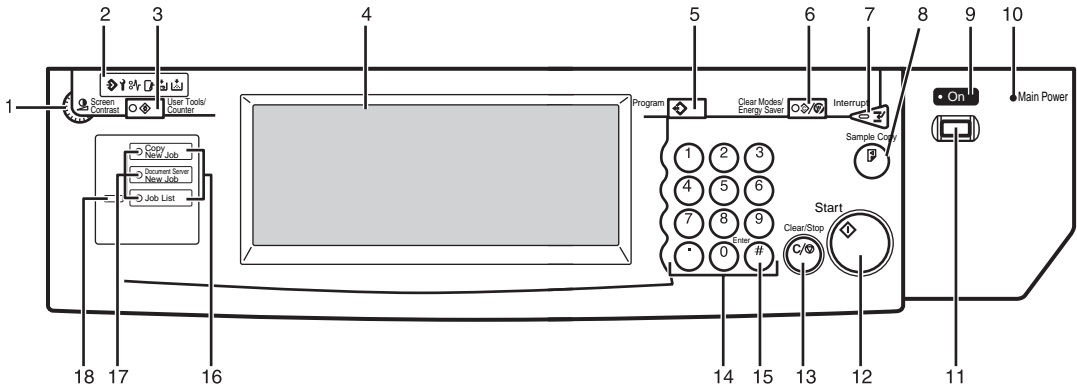

ZBOS040N

1. Screen Contrast knob

Adjusts the brightness of the display panel.

2. Indicators

These indicators show errors or the status of the machine. See ⇒ P.247 “What to Do If Something Goes Wrong”.

3. [User Tools/Counter] key

- User Tools
Press to change the default settings and conditions to meet your requirements.
- Counter
Press to check or print the total number of copies made.

See ⇒ P.305 “User Tools (Copy/Document Server Features)”.

4. Display panel

Shows operation status, error messages, and function menus. See ⇒ P.10 “Display Panel”.

5. [Program] key

Press to select the program mode. See ⇒ P.78 “Programs”.

6. [Clear Modes/Energy Saver] key

- Clear Modes
Press to clear any previously entered copy job settings.

- Energy Saver

Press to switch to and from Energy Saver mode. See ⇒ P.88 “Energy Saver Mode”.

7. [Interrupt] key

Press to make interrupt copies during a copy run. See ⇒ P.88 “Interrupt Copy”.

8. [Sample Copy] key

Use this key to make a single sample copy before starting a long copy run. By checking the sample copy and making any necessary changes to the image quality settings before you make multiple copies, you can save time and paper. See ⇒ P.91 “Sample Copy”.

9. On indicator

This indicator goes on when the operation switch is turned on, and goes off when the switch is turned off.

10. Main power indicator

This indicator goes on when the main power switch is turned on, and goes off when the switch is turned off.

11. Operation switch

Press this switch to turn the power on (the **On** indicator goes on). To turn the power off, press this switch again (the **On** indicator goes off).

12. [Start] key

Press to start copying. Use to set Auto Start. See ⇒ P.90 "Auto Start".

13. [Clear/Stop] key

- Clear
Press to delete a number entered.
- Stop
Press to stop a copy job in progress.

14. Number keys

Use to enter the desired number of copies and data for selected modes.

15. [#] key

Press to enter a value.

16. Function keys

Press the appropriate key to choose any of the following functions:

- Copy
- Document Server
- Job List

17. Function indicators

These indicators go on when the function is selected.

18. Function Status indicator

These show the status of the above functions:

- Green: the function is active.
- Red: the function has been interrupted.



Display Panel

The display panel shows the status of the machine, error messages and function menus.

Important

- Do not apply a strong shock or force of about 30 N (about 3 kgf) or more to the display panel. Otherwise, the display might be damaged.

Note

- The function items displayed serve as selector keys. You can select or specify an item by lightly pressing it.
- When you select or specify an item on the display panel, it is highlighted like .
- Keys appearing as  cannot be used.

Displays and Key Operations

Note

- The following illustrations are examples for the machine with the optional 50-sheet finisher and large capacity tray (LCT) installed.

Initial copy display

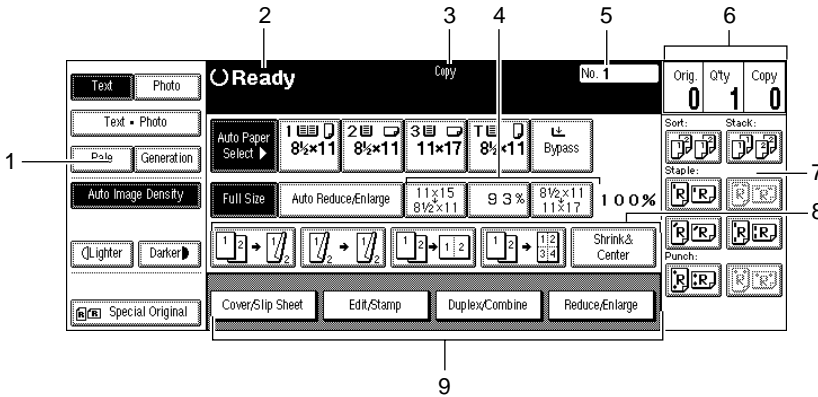

ZBQS050N

1. Original mode, Image Density and Special Original mode.

2. Operational status or messages.

3. The currently selected function (Copy, Document Server).

4. You can register up to three frequently used reduce/enlarge ratios other than the fixed reduce/enlarge ratios. See "Shortcut R/E" in ⇒ P.315 "Reproduction Ratio 1/2".

5. Job ID of the scanned document.

6. The number of originals scanned into memory, number of copies set, and number of copies made.

7. Sort, Stack, Staple or Punch mode.

8. Displays the contents of the Shortcut keys. You can register frequently used functions in these keys. See "Shortcut Keys" in ⇒ P.314 "General Features 3/3".

9. Shows the available functions. Press a function name to display its menu. For example, press the [Reduce/Enlarge] key to bring up the Reduce/Enlarge menu.

❖ Function menu

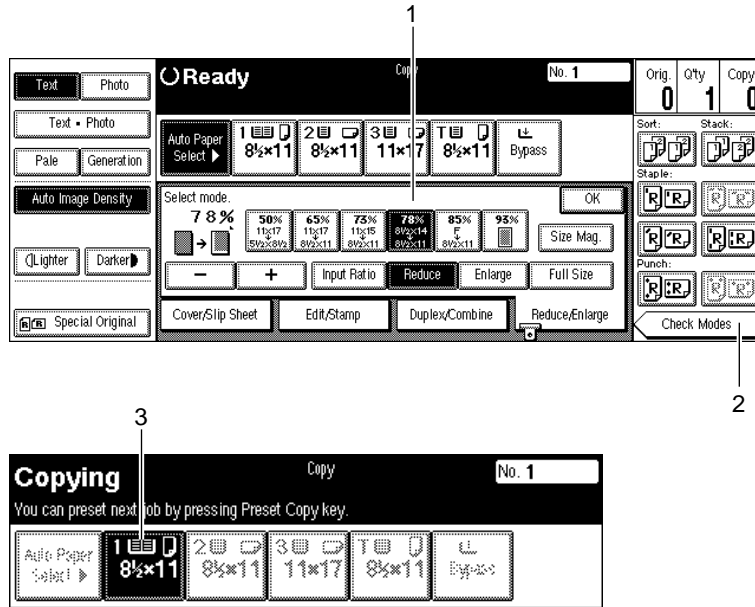

1. Items you can select.

2. The [Check Modes] key appears when you have selected function(s). Press this key to view the functions currently selected.

3. The key highlighted with the lower line underlined indicates the tray feeding the paper.

ZBQS060N

❖ Document Server initial display

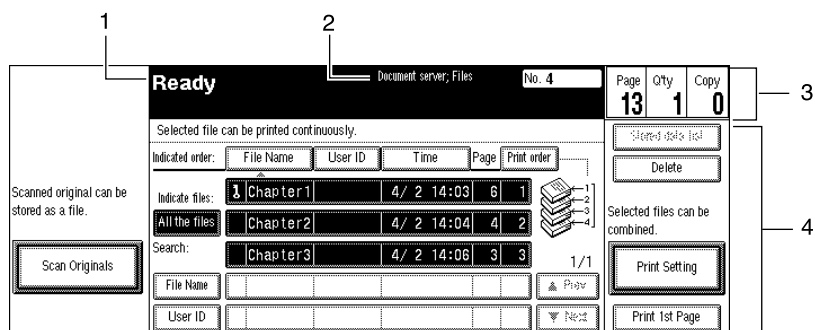

1. Operational status and messages.

2. Display titles.

3. The number of originals scanned into memory, number of copies set, and number of copies made.

4. Operational keys.

ZBQS070N

Function List Based on Options

The functions that are available to you depend on your machine configuration and which options you have. See the table below.

○...Available

×...Not available

	50-Sheet/100-Sheet Finisher (Option)		Booklet Finisher (Option)		Place originals		Connect Copy (Option) ^{*3}
	not installed	installed	not installed	installed	on the exposure glass	in the document feeder	
Batch (SADF)	○	○	○	○	--	○	○
Mixed Sizes	○	○	○	○	--	○	○
Thin	○	○	○	○	--	○	○
Adjusting Image Density	○	○	○	○	○	○	○
Selecting Original Type	○	○	○	○	○	○	○
Selecting Copy Paper	○	○	○	○	○	○	○
Auto Reduce/Enlarge	○	○	○	○	○	○	○
Sort	○	○	○	○	○	○	○
Rotate Sort	○	○ ^{*1}	○	○ ^{*1}	○	○	○
Stack	×	○	×	○	○	○	○
Punch	×	○	×	×	○	○	○
Staple	×	○	×	○ ^{*2}	○	○	○
Copying from the Bypass Tray	○	○	○	○	○	○	× ^{*4}
Program	○	○	○	○	○	○	○ ^{*5}
Job Preset	○	○	○	○	○	○	×
Reduce/Enlarge	○	○	○	○	○	○	○
Zoom	○	○	○	○	○	○	○
Size Magnification	○	○	○	○	○	○	○
Directional Magnification (%)	○	○	○	○	○	○	○
Directional Size Magnification (inch)	○	○	○	○	○	○	○

		50-Sheet/100-Sheet Finisher (Option)		Booklet Finisher (Option)		Place originals		Connect Copy (Option) *3
		not installed	installed	not installed	installed	on the exposure glass	in the document feeder	
Duplex	1 Sided → 2 Sided	<input type="radio"/>	<input type="radio"/>	<input type="radio"/>	<input type="radio"/>	<input type="radio"/>	<input type="radio"/>	<input type="radio"/>
	2 Sided → 2 Sided	<input type="radio"/>	<input type="radio"/>	<input type="radio"/>	<input type="radio"/>	<input type="radio"/>	<input type="radio"/>	<input type="radio"/>
Combine	1 Sided 2 pages → 1 Side	<input type="radio"/>	<input type="radio"/>	<input type="radio"/>	<input type="radio"/>	<input type="radio"/>	<input type="radio"/>	<input type="radio"/>
	1 Sided 4 pages → 1 Side	<input type="radio"/>	<input type="radio"/>	<input type="radio"/>	<input type="radio"/>	<input type="radio"/>	<input type="radio"/>	<input type="radio"/>
	1 Sided 8 pages → 1 Side	<input type="radio"/>	<input type="radio"/>	<input type="radio"/>	<input type="radio"/>	<input type="radio"/>	<input type="radio"/>	<input type="radio"/>
	1 Sided 4 pages → 2 Side	<input type="radio"/>	<input type="radio"/>	<input type="radio"/>	<input type="radio"/>	<input type="radio"/>	<input type="radio"/>	<input type="radio"/>
	1 Sided 8 pages → 2 Side	<input type="radio"/>	<input type="radio"/>	<input type="radio"/>	<input type="radio"/>	<input type="radio"/>	<input type="radio"/>	<input type="radio"/>
	1 Sided 16 pages → 2 Side	<input type="radio"/>	<input type="radio"/>	<input type="radio"/>	<input type="radio"/>	<input type="radio"/>	<input type="radio"/>	<input type="radio"/>
	2 Sided 2 pages → 1 Side	<input type="radio"/>	<input type="radio"/>	<input type="radio"/>	<input type="radio"/>	<input type="radio"/>	<input type="radio"/>	<input type="radio"/>
	2 Sided 4 pages → 1 Side	<input type="radio"/>	<input type="radio"/>	<input type="radio"/>	<input type="radio"/>	<input type="radio"/>	<input type="radio"/>	<input type="radio"/>
	2 Sided 8 pages → 1 Side	<input type="radio"/>	<input type="radio"/>	<input type="radio"/>	<input type="radio"/>	<input type="radio"/>	<input type="radio"/>	<input type="radio"/>
	2 Sided 4 pages → 2 Side	<input type="radio"/>	<input type="radio"/>	<input type="radio"/>	<input type="radio"/>	<input type="radio"/>	<input type="radio"/>	<input type="radio"/>
	2 Sided 8 pages → 2 Side	<input type="radio"/>	<input type="radio"/>	<input type="radio"/>	<input type="radio"/>	<input type="radio"/>	<input type="radio"/>	<input type="radio"/>
	2 Sided 16 pages → 2 Side	<input type="radio"/>	<input type="radio"/>	<input type="radio"/>	<input type="radio"/>	<input type="radio"/>	<input type="radio"/>	<input type="radio"/>

		50-Sheet/100-Sheet Finisher (Option)		Booklet Finisher (Option)		Place originals		Connect Copy (Option) ^{*3}
		not installed	installed	not installed	installed	on the exposure glass	in the document feeder	
Book	Book → 1 Sided	<input type="radio"/>	<input type="radio"/>	<input type="radio"/>	<input type="radio"/>	<input type="radio"/>	<input type="radio"/>	<input type="radio"/>
	2 Sided → 1 Sided	<input type="radio"/>	<input type="radio"/>	<input type="radio"/>	<input type="radio"/>	<input type="radio"/>	<input type="radio"/>	<input type="radio"/>
	1 Sided → 2 Sided	<input type="radio"/>	<input type="radio"/>	<input type="radio"/>	<input type="radio"/>	<input type="radio"/>	<input type="radio"/>	<input type="radio"/>
	2 Sided → 2 Sided	<input type="radio"/>	<input type="radio"/>	<input type="radio"/>	<input type="radio"/>	<input type="radio"/>	<input type="radio"/>	<input type="radio"/>
	Booklet	<input type="radio"/>	<input type="radio"/>	<input type="radio"/>	<input type="radio"/>	<input type="radio"/>	<input type="radio"/>	<input type="radio"/>
	Magazine	<input type="radio"/>	<input type="radio"/>	<input type="radio"/>	<input type="radio"/>	<input type="radio"/>	<input type="radio"/>	<input type="radio"/>
Cover/Designate/Chapters		<input type="radio"/>	<input type="radio"/>	<input type="radio"/>	<input type="radio"/>	<input type="radio"/>	<input type="radio"/>	<input type="radio"/>
Slip Sheet		<input type="radio"/>	<input type="radio"/>	<input type="radio"/>	<input type="radio"/>	<input type="radio"/>	<input type="radio"/>	<input type="radio"/>
Double		<input type="radio"/>	<input type="radio"/>	<input type="radio"/>	<input type="radio"/>	<input type="radio"/>	<input type="radio"/>	<input type="radio"/>
Repeat		<input type="radio"/>	<input type="radio"/>	<input type="radio"/>	<input type="radio"/>	<input type="radio"/>	<input type="radio"/>	<input type="radio"/>
Margin Adjust		<input type="radio"/>	<input type="radio"/>	<input type="radio"/>	<input type="radio"/>	<input type="radio"/>	<input type="radio"/>	<input type="radio"/>
Erase		<input type="radio"/>	<input type="radio"/>	<input type="radio"/>	<input type="radio"/>	<input type="radio"/>	<input type="radio"/>	<input type="radio"/>
Centering		<input type="radio"/>	<input type="radio"/>	<input type="radio"/>	<input type="radio"/>	<input type="radio"/>	<input type="radio"/>	<input type="radio"/>
Stamp	Background Numbering	<input type="radio"/>	<input type="radio"/>	<input type="radio"/>	<input type="radio"/>	<input type="radio"/>	<input type="radio"/>	<input type="radio"/>
	Preset Stamp	<input type="radio"/>	<input type="radio"/>	<input type="radio"/>	<input type="radio"/>	<input type="radio"/>	<input type="radio"/>	<input type="radio"/>
	User Stamp	<input type="radio"/>	<input type="radio"/>	<input type="radio"/>	<input type="radio"/>	<input type="radio"/>	<input type="radio"/>	<input type="radio"/> ^{*5}
	Date Stamp	<input type="radio"/>	<input type="radio"/>	<input type="radio"/>	<input type="radio"/>	<input type="radio"/>	<input type="radio"/>	<input type="radio"/>
	Page Numbering	<input type="radio"/>	<input type="radio"/>	<input type="radio"/>	<input type="radio"/>	<input type="radio"/>	<input type="radio"/>	<input type="radio"/>

^{*1} You can use this function when “Rotate Sort” is selected in “Select Stack or Rotate sort” of the User Tools.

^{*2} The Saddle Stitch function is available.

^{*3} When the same type of finishers are equipped with the master and sub-unit.

^{*4} You can set only cover sheets and slip sheets.

^{*5} The program stored in the master unit is recalled. However, functions not available in Connect Copy mode or in the sub-unit are canceled.

Turning On the Power

To turn the machine on, press the operation switch.

Note

- ❑ This machine automatically enters Energy Saver mode or turns itself off if you do not use the machine for a while. See “Auto Off” in ⇒ P.29 “Basic Procedure” and “Auto Off Timer” in the System Settings manual.

Power switches

This machine has two power switches.

❖ Operation switch (right side of the control panel)

Press this switch to activate the machine. When the machine has warmed up, you can make copies.

❖ Main power switch (left side of the machine)

When the machine is not to be used for an extended period of time, turn off the main power switch.

Turning On the Main Power

1 Make sure that the power cord is firmly plugged into the wall outlet.

2 Turn on the main power switch.

The **main power** indicator on the control panel goes on.

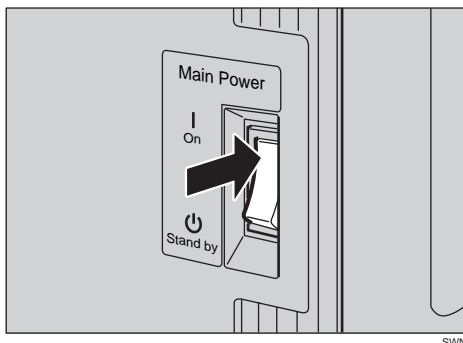

SWN

Starting the Machine

- 1** Press the operation switch to make the On indicator go on.

The display panel will come on.

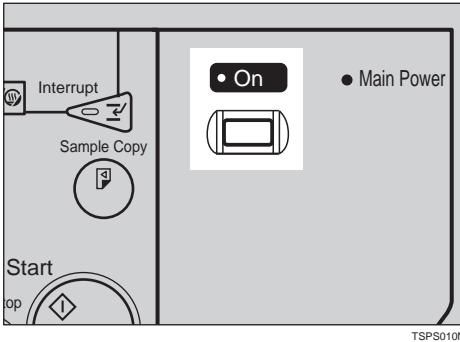

Note

- If the power is not turned on when the operation switch is pressed, check if the main power switch is on. If off, turn it on.
- During the warm-up period (less than 330 seconds), you can use the Auto Start function. See ⇒ P.90 "Auto Start".
- You can set up a copy job and press the **[Start]** key while the "Select modes and press the start key. Scanning originals can be started." message is displayed.
- When "Input user code, then press # ." is displayed, enter your user code. See ⇒ P.90 "User Codes".

Shutting Down the Machine

- 1** Press the operation switch to make the On indicator go off.

Turning Off the Main Power

- 1** Turn off the main power switch.

The **main power** indicator of the control panel goes off.

Originals

Sizes and Weights of Recommended Originals

1

❖ Metric version

Where Original Is Set	Original Size	Original Weight
Exposure glass	Up to A3	--
Document feeder	1-sided originals: A3☐ – A5☐	52 – 157g/m ² *2
	2-sided originals: A3☐ – A5☐☐	52 – 128g/m ²
	Thin originals: A3☐ – B6☐☐ *1	41 – 157g/m ²

*1 Except B6☐

*2 A5☐, B6☐☐, 52 – 128g/m²

❖ Inch version

Where Original Is Set	Original Size	Original Weight
Exposure glass	Up to 11" × 17"	--
Document feeder	1-sided originals: 11" × 17"☐ – 5 ¹ / ₂ " × 8 ¹ / ₂ "☐	14 – 42 lb. Bond *1
	2-sided originals: 11" × 17"☐ – 5 ¹ / ₂ " × 8 ¹ / ₂ "☐☐	14 – 34 lb. Bond
	Thin originals: 11" × 17"☐ – 5 ¹ / ₂ " × 8 ¹ / ₂ "☐☐	11 – 42 lb. Bond

*1 5¹/₂" × 8¹/₂"☐, 14 – 34 lb. Bond

Note

☐ The number of originals that can be set in the document feeder is about 100.

Non-recommended originals for the document feeder

Setting the following types of originals in the document feeder can cause paper misfeeds or damage to the originals. Set these originals on the exposure glass instead.

- Originals other than those specified in ⇒ P.19 "Sizes and Weights of Recommended Originals"

- Stapled or clipped originals
- Perforated or torn originals
- Curled, folded, or creased originals
- Pasted originals
- Originals with any kind of coating, such as thermal fax paper, art paper, aluminum foil, carbon paper, or conductive paper
- Originals with perforated lines
- Originals with indexes, tags, or other projecting parts
- Sticky originals such as translucent paper
- Thin originals that have low stiffness
- Thick originals such as postcards
- Originals of inappropriate weight
- Bound originals such as books
- Transparent originals such as OHP transparencies or translucent paper

Sizes Detectable by the Auto Paper Select

◆ Metric version

Size	A3	B4	A4	B5	A5	A5	B6	11"	11"	8 ¹ / ₂ "	8 ¹ / ₂ "	5 ¹ / ₂ "	8 ¹ / ₂ "	8K	16
Place of original			 	 			 	" × 17" 	" × 15" 	2" × 14" 	2" × 11" 	× 8 ¹ / ₂ " 	2" × 13" *1		K
Exposure glass	○	○	○	○	○	×	×	×	×	×	×	×	○	×	×
Document feeder	○	○	○	○	○	○	○	○	×	×	○	×	○	○	○

*1 You can select from 8¹/₂" × 13", 8¹/₄" × 13" and 8" × 13" with the User Tools (System Settings). See "<F/F4>Size Setting" in the System Settings manual.

❖ Inch version

Size	A3	B4	A4	B5	A5	A5	B6	11" × 17"	11" × 15"	10" × 14"	8" × 10"	8 1/2" × 14"	8 1/2" × 11"	5 1/2" × 8 1/2"	8 1/2" × 13" *1
Place of original	☐	☐	☐ ☐	☐ ☐	☐	☐	☐ ☐	☐	☐	☐	☐	☐	☐ ☐	☐ ☐	☐ ☐
Exposure glass	×	×	×	×	○	×	×	○	×	×	×	○	○	×	×
Document feeder	×	×	○	×	×	×	×	○	×	○	○	○	○	○	○

*1 You can select from 8 1/2" × 13", 8 1/4" × 13" and 8" × 13" with the User Tools (System Settings). See "<F/F4>Size Setting" in the System Settings manual.

Sizes difficult to detect

It is difficult for the machine to detect the sizes of the following originals, so select the paper size manually.

- Originals with indexes, tags, or other projecting parts
- Transparent originals such as OHP transparencies or translucent paper
- Dark originals with many letters and drawings
- Originals which partially contain a solid image
- Originals which have solid images at their edges

Missing Image Area

❖ Exposure glass

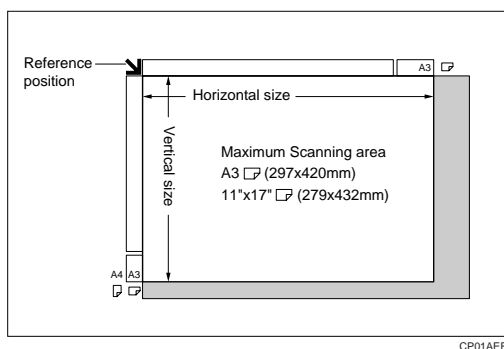

❖ Document feeder

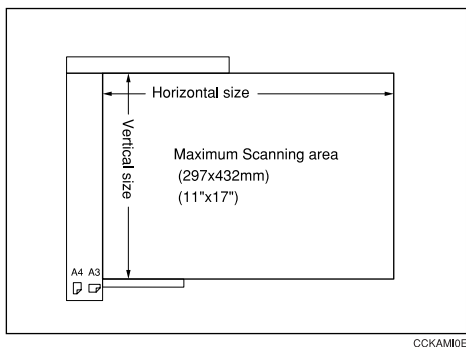

! Limitation

- ❑ Even if you correctly set originals in the document feeder or on the exposure glass, 3mm (0.1") margins on all four sides might not be copied.

Copy Paper

Recommended Paper Sizes and Types

The following limitations apply to each tray:

	Metric version	Inch version	Paper weight	Paper capacity
Tray 1 ^{*1}	A4 ☐, 8 1/2" × 11" ☐		52 – 128g/m ² , 14 – 34 lb. Bond ^{*6}	1550 + 1550 sheets
Tray 2	<p>A3 ☐, (B4 ☐), A4 ☐ ☐, (B5 ☐ ☐), A5 ☐ ☐, (11" × 17" ☐), (8 1/2" × 14" ☐), (8 1/2" × 11" ☐), (8 1/2" × 13" ☐), 8 1/2" × 13" ☐, (8" × 10 1/2" ☐), (8" × 10" ☐), (8" × 13" ☐), 8 1/4" × 13" ☐, (10" × 14" ☐), (11" × 15" ☐), (5 1/2" × 8 1/2" ☐ ☐) (8K ☐ ^{*8}), (16K ☐ ☐ ^{*9}), (tab stocks)</p> <p>Note</p> <ul style="list-style-type: none"> ☐ You have to specify the paper size with the User Tools (System Settings). See "Paper Size Setting" in the System Settings manual. ☐ When selecting paper sizes in parentheses, set the paper size selector knob to the ✱ mark on the left. See ⇒ P.282 "Changing the Paper Size". 	<p>(A3 ☐), (B4 ☐), (A4 ☐ ☐), (B5 ☐ ☐), (A5 ☐ ☐), 11" × 17" ☐, 8 1/2" × 14" ☐, 8 1/2" × 11" ☐ ☐, (8 1/2" × 13" ☐), 8" × 10 1/2" ☐, 8" × 10" ☐, 8" × 13" ☐, (8 1/4" × 13" ☐), 10" × 14" ☐, (11" × 15" ☐), 5 1/2" × 8 1/2" ☐ ☐, (tab stocks)</p> <p>Note</p> <ul style="list-style-type: none"> ☐ You have to specify the paper size with the User Tools (System Settings). See "Paper Size Setting" in the System Settings manual. ☐ When selecting paper sizes in parentheses, set the paper size selector knob to the ✱ mark on the left. See ⇒ P.282 "Changing the Paper Size". 	52 – 128g/m ² , 14 – 34 lb. Bond ^{*6}	550 sheets

		Metric version	Inch version	Paper weight	Paper capacity
Tray 3 ^{*1}		A3☐, B4☐, A4☐☐, B5☐☐, A5☐☐, 11" × 17"☐, 8 ¹ / ₂ " × 14"☐, 8 ¹ / ₂ " × 11"☐☐, 8 ¹ / ₂ " × 13"☐, 8" × 10 ¹ / ₂ "☐, 8" × 10"☐, 8" × 13"☐, 8 ¹ / ₄ " × 13"☐, 10" × 14"☐, 11" × 15"☐, 5 ¹ / ₂ " × 8 ¹ / ₂ "☐☐	A3☐, B4☐, A4☐☐, B5☐☐, A5☐☐, 11" × 17"☐, 8 ¹ / ₂ " × 14"☐, 8 ¹ / ₂ " × 11"☐☐, 8 ¹ / ₂ " × 13"☐, 8" × 10 ¹ / ₂ "☐, 8" × 10"☐, 8" × 13"☐, 8 ¹ / ₄ " × 13"☐, 10" × 14"☐, 11" × 15"☐, ☐, 5 ¹ / ₂ " × 8 ¹ / ₂ "☐☐	52 – 128g/m ² , 14 – 34 lb. Bond ^{*6}	550 sheets
Large Capacity Tray (LCT) ^{*1}		A4☐, B5☐, 8 ¹ / ₂ " × 11"☐	A4☐, B5☐, 8 ¹ / ₂ " × 11"☐, 8 ¹ / ₂ " × 14"☐ ^{*7}	64 – 105g/m ² , 16 – 24 lb. Bond	3,500 sheets
Bypass tray ^{*3} ^{*4} ^{*5}	Standard size	A3☐, B4☐, A4☐☐, B5☐☐, A5☐☐, B6☐, A6☐, 11" × 17"☐, 8 ¹ / ₂ " × 14"☐, 8 ¹ / ₂ " × 11"☐☐, 8 ¹ / ₂ " × 13"☐, 8" × 10 ¹ / ₂ "☐☐, 8" × 10"☐☐, 8" × 13"☐, 8 ¹ / ₄ " × 13"☐, 10" × 14"☐, 11" × 15"☐, ☐, 5 ¹ / ₂ " × 8 ¹ / ₂ "☐☐	A3☐, B4☐, A4☐☐, B5☐☐, A5☐☐, B6☐, A6☐, 11" × 17"☐, 8 ¹ / ₂ " × 11"☐☐, 8 ¹ / ₂ " × 13"☐, 8" × 10 ¹ / ₂ "☐☐, 8" × 10"☐☐, 8" × 13"☐, 8 ¹ / ₄ " × 13"☐, 10" × 14"☐, 11" × 15"☐, 5 ¹ / ₂ " × 8 ¹ / ₂ "☐☐	52 – 157g/m ² , 14 lb. Bond – 90 lb. Index 52 – 200g/m ² , 14 lb. Bond – 110 lb. Index ^{*10}	50 sheets
	Non-standard size ^{*2}	Vertical: 100 – 300mm Horizontal: 140 – 432mm	Vertical: 4.0" – 11.7" Horizontal: 5.5" – 17.0"	52 – 157g/m ² , 14 lb. Bond – 90 lb. Index 52 – 200g/m ² , 14 lb. Bond – 110 lb. Index ^{*10}	1 sheet
		Postcards, adhesive labels, translucent paper, OHP transparencies ^{*4}			

^{*1} The paper tray fence is fixed. If you wish to change the size of paper set in this tray, contact your service representative.

^{*2} If you wish to copy onto non-standard size paper, set the paper in the bypass tray and specify the size. See ⇒ P.73 "Copying from the Bypass Tray".

^{*3} If you wish to copy onto OHP transparencies or thick paper, select OHP or Thick Paper mode. See ⇒ P.76 "When Copying onto OHP Transparencies or Thick Paper".

^{*4} Always set one sheet at a time. See ⇒ P.73 "Copying from the Bypass Tray".

^{*5} When setting copy paper, make sure that the stack height does not exceed the limit mark. The maximum number of sheets you can set at a time depends on the paper thickness and condition.

^{*6} If you wish to copy onto thick (105g/m², 28 lb. Bond or heavier) paper, select Thick Paper mode. See "Special Paper Indication" in the System Settings manual.

^{*7} The optional 8¹/₂" × 14" paper size tray is required to set this size of paper.

^{*8} 8K (Ba-kai) = 267 × 390mm

^{*9} 16K (Shi-Liu-kai) = 195 × 267mm

^{*10} When the optional 100 sheet finisher is installed.

Important

- ❑ If you use damp or curled paper, a misfeed might occur. In this case, try turning over the paper stack in the paper tray. If there is no improvement, change to copy paper with less curl.

Note

- ❑ When you use the bypass tray, be sure to set the copy paper direction to .
- ❑ Postcards should be fed from the bypass tray.
- ❑ If you load paper of the same size and in the same direction in two or more trays, the machine automatically shifts to another tray when the tray in use runs out of paper. This function is called "Auto Tray Switching". (If you put recycled paper, translucent paper, user color paper 1, or user color paper 2 in paper trays with "Special Paper Indication", this function is not available to these trays unless their settings are identical.) This saves interrupting a copy run to replenish paper even when you make a large number of copies. You can cancel this setting. See "Auto Paper Select" in ⇒ P.43 "Selecting Copy Paper", "Auto Tray Switching" and "Special Paper Indication" in the System Settings manual.
- ❑ If you select Thick Paper mode or Tab Stock mode, copying speed might be reduced.

Non-recommended Paper

CAUTION:

- *Do not use aluminum foil, carbon paper, or similar conductive paper to avoid a fire or equipment failure.*

Important

- ❑ Do not use any of the following kinds of paper or a fault might occur.
 - Thermal fax paper
 - Art paper
 - Aluminum foil
 - Carbon paper
 - Conductive paper
 - Colored OHP transparencies
 - Paper with perforated lines
 - Hemmed paper
- ❑ Do not use copy paper that has been already copied on. Otherwise, a paper misfeed might occur.

 **Note**

- Do not use the following kinds of paper or a misfeed might occur.
 - Bent, folded, or creased paper
 - Torn paper
 - Slippery paper
 - Perforated paper
 - Rough paper
 - Thin paper that has low stiffness
 - Paper with much paper dust on its surface
- If you make a copy on rough grain paper, the copy image might be blurred.
- Do not use paper which has been copied or printed on.

Paper Storage

 **Note**

- When storing paper, the following precautions should always be followed:
 - Do not store paper where it will be exposed to direct sunlight.
 - Avoid storing paper in humid areas (humidity: 70% or less).
 - Store on a flat surface.
- Keep open reams of papers in the package, and store as you would unopened paper.
- Under high temperature and high humidity, or low temperature and low humidity conditions, store paper in a vinyl bag.

Toner

Handling Toner

 **WARNING:**

- *Do not incinerate used toner or toner containers. Toner dust might ignite when exposed to an open flame. Dispose of used toner containers in accordance with local regulations for plastics.*

 **CAUTION:**

- *Keep toner (used or unused) and toner containers out of reach of children.*

 **CAUTION:**

- *Our products are engineered to meet high standards of quality and functionality, and we recommend that you only use the expendable supplies available at an authorized dealer.*

 **Important**

- If you use toner other than the recommended type, a fault might occur.

Toner Storage

When storing toner, the following precautions should always be followed:

- Store toner containers in a cool, dry place free from direct sunlight.
- Store on a flat surface.
- Store toner containers laid down.

Used Toner

 **Note**

- Used toner cannot be re-used.

2. Copying

Basic Procedure

- 1 Make sure that the machine is in Copy mode.

If the machine is not in Copy mode, press the **[Copy/New Job]** key.

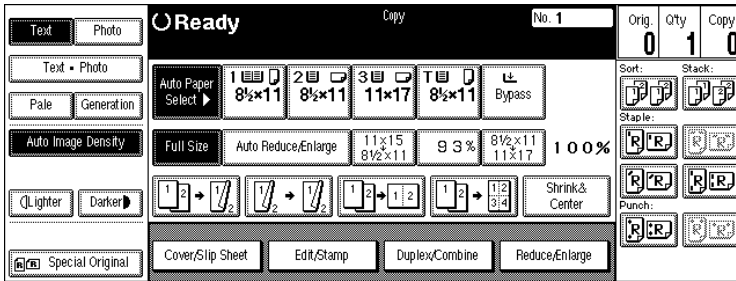

- 2 When the machine is set for the user code, enter the user code with the number keys and then press the **[#]** key.

Reference

⇒ P.90 "User Codes".

- 3 Make sure that there are no previous settings remaining.

Note

□ To clear settings, press the **[Clear Modes/Energy Saver]** key.

- 4 Set your originals.

Reference

⇒ P.31 "Setting Originals".

- 5 Set your desired settings.

- 6 Enter the number of copies required with the number keys.

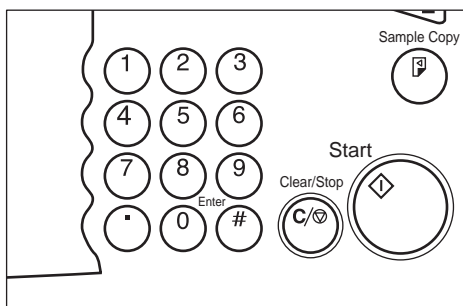

 **Note**

- The maximum copy quantity can be set between 1 and 999 (default: 999). See “Maximum Copy Quantity” in ⇒ P.313 “General Features ²/₃”.
- To change the number entered, press the **[Clear/Stop]** key and enter the new number.

7 Press the **[Start]** key.

The machine starts copying.

 **Note**

- When you set originals on the exposure glass, press the **[#]** key after all originals are scanned.
- Usually, when you set a single original on the exposure glass or in the document feeder, the copied paper is delivered face up. However, with some functions, copies will be delivered face down.
- You can choose to have copies delivered either face up or face down (except for copying through the bypass tray). See “Face-Up/Down Selection in Platen Mode” in ⇒ P.329 “Input/Output”.
- To stop the machine during the multi-copy run, press the **[Clear/Stop]** key.
- To return the machine to the initial condition after copying, press the **[Clear Modes/Energy Saver]** key.

 **Auto Reset**

The machine returns to its initial condition automatically when your job is finished, after a certain period of time. This function is called “Auto Reset”.

 **Note**

- You can change the Auto Reset time. See “Auto Reset Timer” in ⇒ P.310 “General Features ¹/₃”.

 **Auto Off**

The machine turns itself off automatically after your job is finished, after a certain period of time. This function is called “Auto Off”.

 **Note**

- You can change the Auto Off time. See “Auto Off Timer” in the System Settings manual.

Setting Originals

⚠ Limitation

- ❑ Set originals after correction fluid and ink has completely dried. Not taking this precaution could mark the exposure glass and cause marks to be copied.

📌 Note

- ❑ Basically originals should be aligned to the rear left corner. However, some copy functions may produce different results depending on the direction of the originals. For details, see the explanations of each function.

	Original	Exposure glass	Document feeder
Standard			
90° Turn			

GOGSET1E

🔍 Reference

⇒ P.19 "Originals".

Setting Originals on the Exposure Glass

1 Lift the document feeder.

⚠ Important

- ❑ Do not open the document feeder with a force. Otherwise, the cover of the document feeder might open or be damaged.

📌 Note

- ❑ Be sure to open the document feeder by more than 30°. Otherwise the original size might not be detected correctly.

- 2** Set the original face down on the exposure glass. The original should be aligned to the rear left corner.

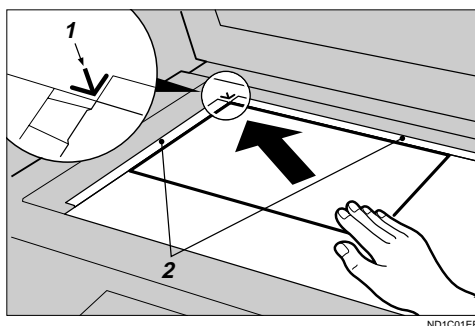

1: Reference mark

2: Scale

 **Note**

- Start with the first page to be copied.

- 3** Lower the document feeder.

Setting Originals in the Document Feeder

 **Note**

- The last page should be on the bottom.
- Do not stack originals beyond the limit mark on the side fence of the document feeder.
- When copying thin originals (40 – 52g/m², 11 – 14 lb. Bond), set one original in the document feeder at a time or place it on the exposure glass to avoid damage due to a multi-sheet feed (several pages fed together at the same time).
- The original might become dirty if it is written with a pencil or similar tools.
- Usually, one-sided originals are delivered to the ADF external tray, and two-sided originals to the ADF tray.

 **Reference**

Regarding originals that the document feeder can handle, see ⇒ P.19 “*Originals*”.

1 Set the aligned originals face up into the document feeder.

Setting a stack of originals is completed when the bottom plate rises.

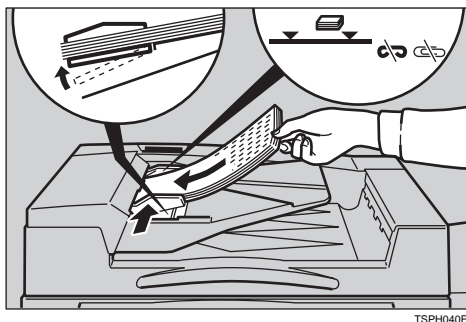

TSPH040E

Important

- After the bottom plate of the document feeder rises, do not add or force in originals.

Note

- Straighten curls in the originals before setting them in the document feeder.
- To avoid a multi-sheet feed, shuffle the originals before setting them in the document feeder.
- You can set the timing for the bottom plate of the document feeder to rise. See "ARDF Original Table Rise Time" in ⇒ P.329 "Input/Output".

Original Orientation

You can set the original orientation separately in the following ways.

This function is useful for copying torn originals or large originals.

❖ Standard Orientation

Select this function when the original direction is the same as the copy paper direction.

❖ 90° Turn

This function rotates the copy image by 90°.

Use this function when you want to copy onto A3, B4, 11" × 17" paper.

1 Press the [Special Original] key.

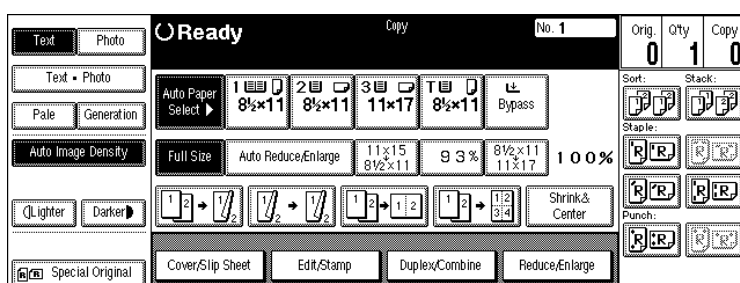

2 Select the original orientation.

Standard Orientation

1 Make sure that the [Standard Orientation] key is selected.

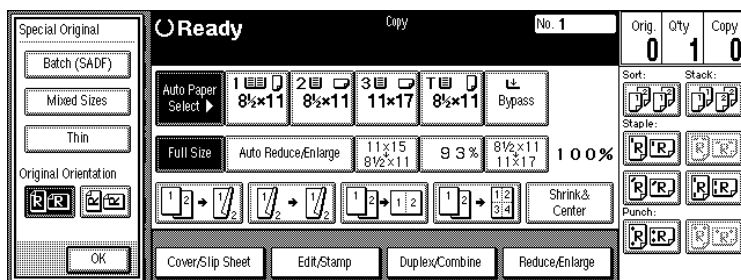

90° Turn

When you want to copy A3, B4 or 11" × 17" size originals, set your original in the landscape orientation and then press the **[90° Turn]** key. The machine rotates the original image and you can make copies as you wish. This is useful for copying large originals with the Staple, Punch, Duplex, Combine or Stamp functions.

For example, if you want to copy A3 or 11" × 17" originals with for the Staple function configured as shown below:

Note

- It is recommended to use this function together with the Auto Paper Select or Preset Reduce/Enlarge function.

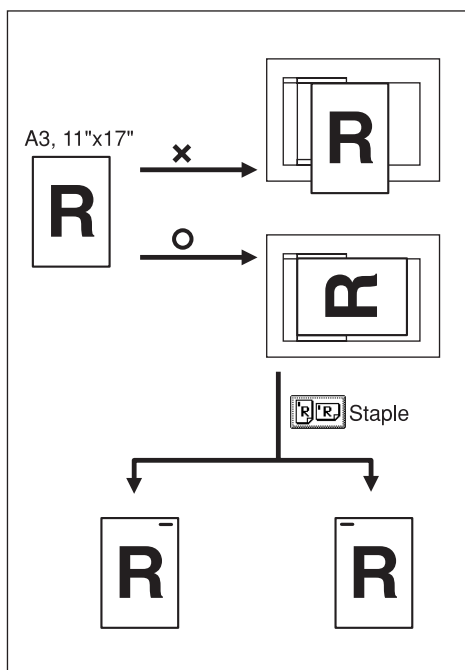
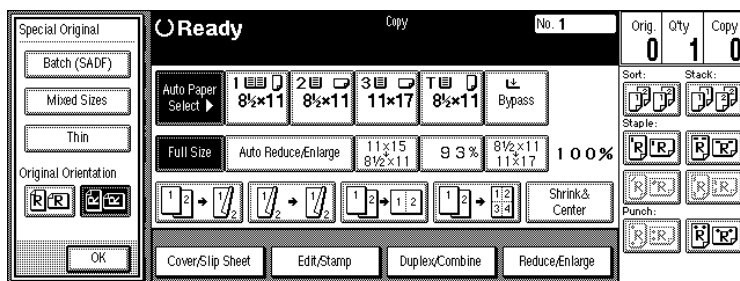
**1** Press the [90° Turn] key.**3** Press the [OK] key.

Setting Special Originals

Use this function when you want to use Batch (SADF), Mixed Sizes, Thin mode, or when you select the original orientation.

Batch (SADF) mode

2

Up to 100 standard originals can be set in the document feeder at a time. If there are more than 100 originals, set Batch (SADF) mode so that originals can be fed automatically without pressing the **[Start]** key each time they are set in the document feeder.

Important

- When setting special originals such as translucent paper, set them one by one.

Note

- In Batch (SADF) mode, even when one original is set in the document feeder, the original is automatically fed each time it is set.

1 Press the **[Special Original]** key.

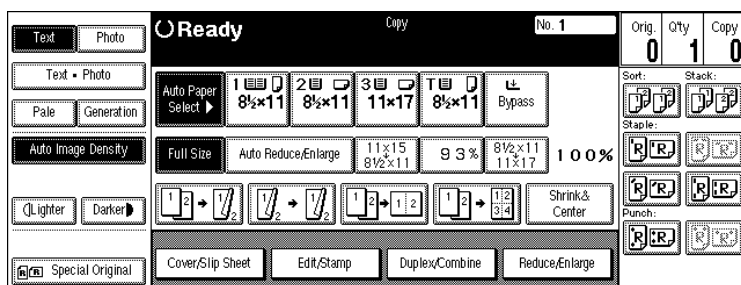

2 Press the **[Batch (SADF)]** key.

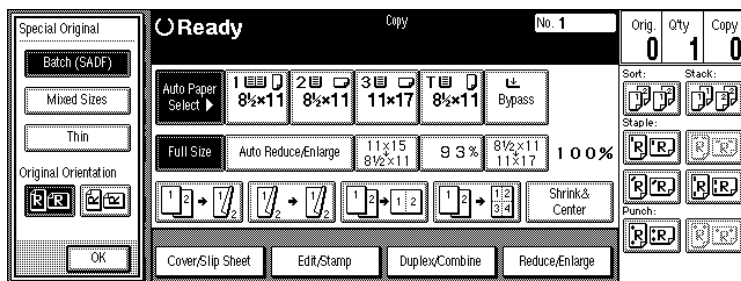

3 Press the **[OK]** key.

4 Set your originals, then press the **[Start]** key.

The **Auto Feed** indicator of the document feeder goes on.

- 5** After all the previously set originals are fed, set the next originals while the **Auto Feed** indicator is on.

The second and subsequent originals can be fed automatically without pressing the **[Start]** key.

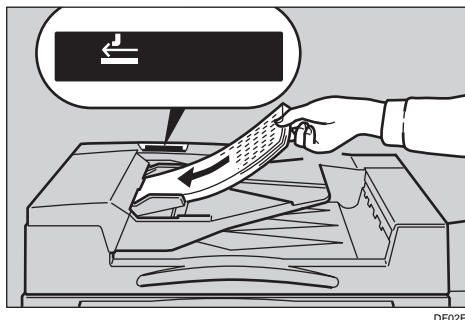

Note

- When the Sort, Combine or Duplex function has been set, press the **[#]** key after all originals are scanned.
- You can change the lighting-up time of the **Auto Feed** indicator. See “Batch (SADF) Auto Reset Time” in ⇒ P.329 “Input/Output”.

Mixed Sizes mode

When originals of different sizes are set on the document feeder at a time, the machine automatically checks the size of the originals and makes copies.

Limitation

- When setting originals of different sizes on the document feeder and making copies without using Mixed Sizes mode, parts of the original image might not be copied.
- The weight of originals that can be set with this function is 52 – 81g/m², 14 – 20 lb. Bond.
- The original sizes that can be set with this function are as follows:

Metric version	A3☐, B4☐, A4☐☐, B5☐☐
Inch version	11" × 17"☐, 8 ¹ / ₂ " × 14"☐, 8 ¹ / ₂ " × 11"☐☐, 5 ¹ / ₂ " × 8 ¹ / ₂ "☐☐

- For smaller originals, the copy image might be slanted since the originals might not be correctly aligned with the original guide.

1 Press the [Special Original] key.

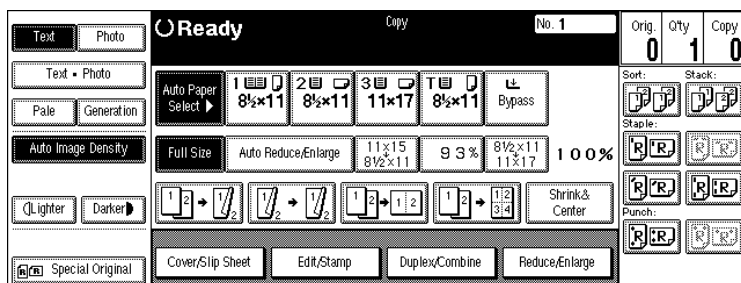

2

2 Press the [Mixed Sizes] key.

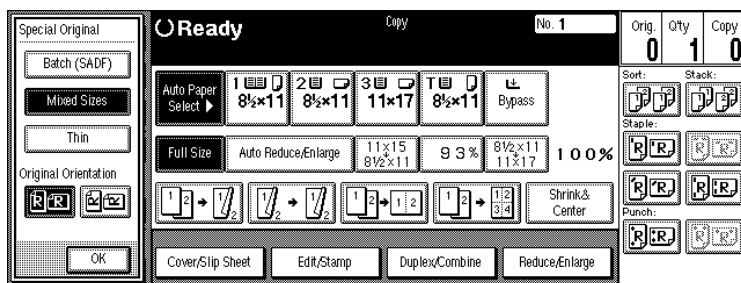

3 Press the [OK] key.

4 Align the rear and left edges of the originals as shown in the illustration.

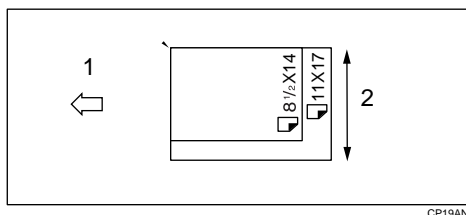

CP19AN

1: Set into the document feeder.

2: Vertical size

Important

- If the originals are of different vertical sizes, put the longer original on the bottom, otherwise the sizes might not be detected correctly.

5 Adjust the guide to the widest original size.

6 Set the aligned originals face up into the document feeder.

Thin mode

Use Thin mode if the scanned image is distorted at the edges when copying thin (52g/m², 14 lb. Bond or lighter) originals.

Important

- Set to Thin mode when you place thin paper into the document feeder, otherwise your originals might be damaged.

1 Press the [Special Original] key.

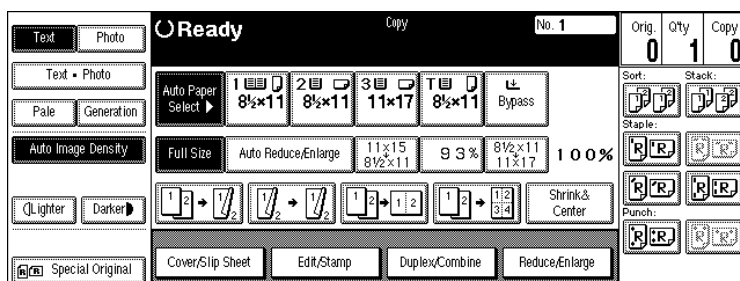

2 Press the [Thin] key.

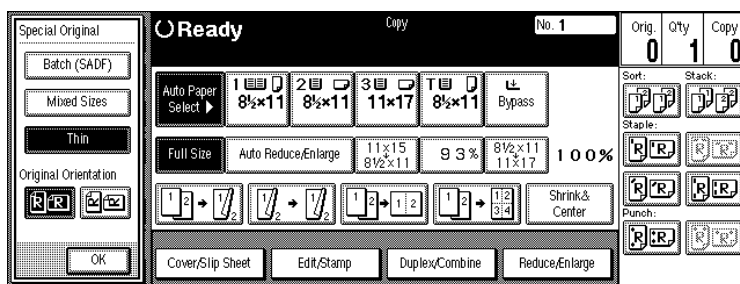

3 Press the [OK] key.

Basic Functions

The following basic functions are explained in this section.

❖ Adjusting Copy Image Density

Auto and Manual Image Density

❖ Selecting Original Type Setting

Text, Text-Photo, Photo, Pale, Generation Copy

❖ Selecting Copy Paper

Auto Paper Select and Manual Paper Select

❖ Auto Reduce/Enlarge

The machine can choose an appropriate reproduction ratio based on the paper and original sizes you select.

Note

- You can select functions to be activated when Auto Reset is turned on, when Energy Saver is turned off, or after the machine is powered on. See ⇒ P.310 “General Features ¹/₃”.
- You can change default settings for basic functions. See ⇒ P.310 “Settings You Can Change with the User Tools”.

Adjusting Copy Image Density

You can adjust the copy image density to match your originals.

There are three types in this function:

❖ Auto Image Density

The machine automatically adjusts the image density.

❖ Manual Image Density

If you require darker or lighter copies, adjust the image density yourself.

❖ Combined Auto and Manual Image Density

Use when copying originals with a dirty background (such as newspapers). You can adjust the foreground density while leaving the background unchanged.

Note

- ❑ In Connect Copy mode, make adjustments to copy image density on the master unit.
 - The image density level set on the master unit will be used by both units, However, in order to produce similar images on both units, make sure that the “Original Mode Quality Level” settings are the same on each unit. If they are not the same, the finish of images may differ. See “Original Mode Quality Level” in ⇒ P.310 “General Features 1/3”.

1 Select one of Image Density modes.

Auto Image Density

1 Make sure that the [Auto Image Density] key is selected.

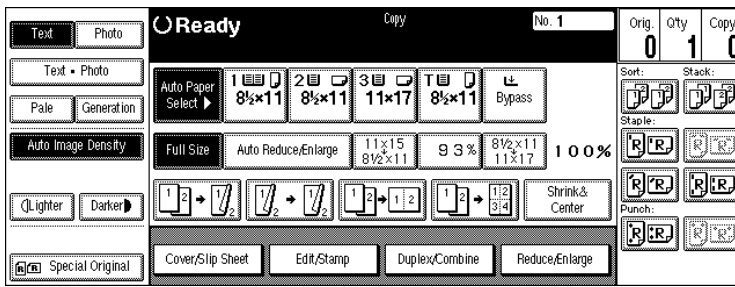

Note

- ❑ If the [Auto Image Density] key is not selected, press the [Auto Image Density] key.
- ❑ If you do not wish to set any other functions, press the [Start] key to start copying.

Manual Image Size Density

- 1 Press the [Auto Image Density] key to cancel it.
- 2 Press the [Lighter] or [Darker] key to adjust the image density.

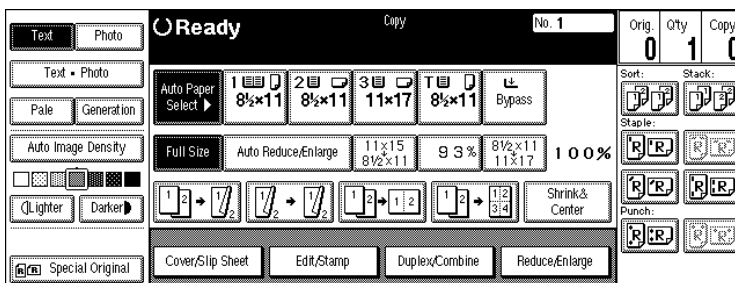

Note

- ❑ If you do not wish to set any other functions, press the [Start] key to start copying.

Combined Auto and Manual Image Density

- ❶ Make sure that the [Auto Image Density] key is selected.
- ❷ Press the [Lighter] or [Darker] key to adjust the density.

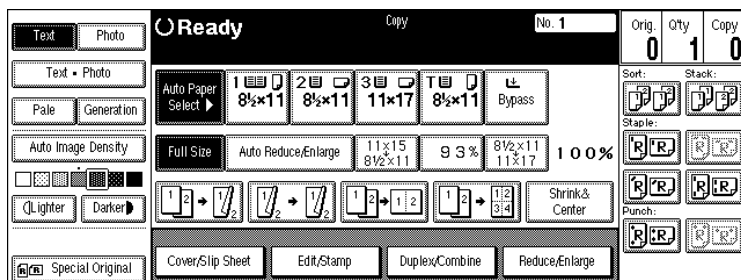

Note

- If you do not wish to set any other functions, press the [Start] key to start copying.

Selecting Original Type Setting

Select one of the following types to match your originals:

- ❖ **Text**
Select this mode when your originals contain only letters (no pictures).
- ❖ **Text-Photo**
Select Text-Photo when your originals contain photographs or pictures with letters.
- ❖ **Photo**
Delicate tones of photographs and pictures can be reproduced with this mode.
- ❖ **Pale**
Select this mode for originals that have lighter lines written in pencil, or for faint copied slips. The faint lines will be clearly copied.
- ❖ **Generation Copy**
If your originals are copies (generation copies), the copy image can be reproduced sharply and clearly.

Note

- You can directly display the [Original Mode] key on the copy original display. See "Original Mode Display" in ⇒ P.310 "General Features 1/3".
- You can adjust the quality level for each original type. See "Original Mode Quality Level" in ⇒ P.310 "General Features 1/3".
- In Connect Copy mode, make adjustments to the original type on the master unit.

1 Press the appropriate key to select the original type.

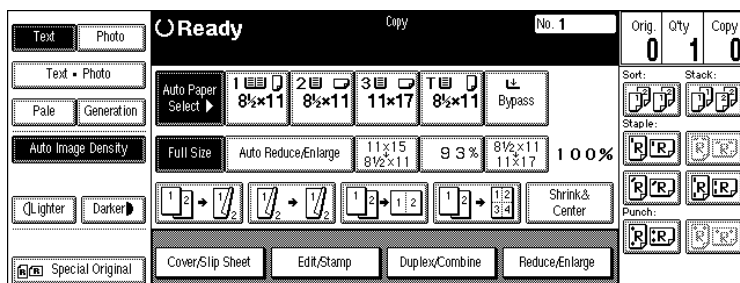

Note

- If "Yes" has been selected in "Original Mode Display" of the User Tools, press the **[Original Mode]** key to select the original type, then press the **[OK]** key. See "Original Mode Display" in ⇒ P.310 "General Features ¹/₃".

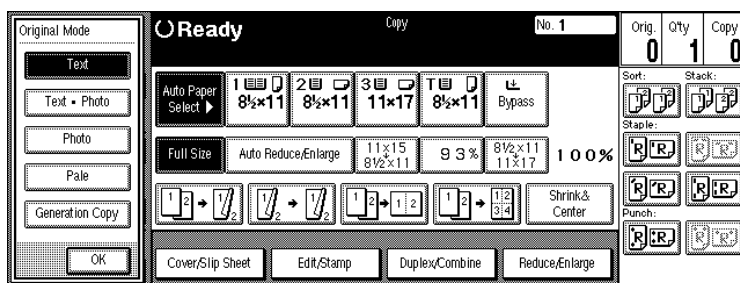

- If you do not wish to set any other functions, press the **[Start]** key to start copying.

Selecting Copy Paper

There are two ways to select copy paper:

❖ Auto Paper Select

The machine selects a suitable size of copy paper automatically based on the original size and the reproduction ratio. ⇒ P.46 "Rotated copy".

❖ Manual Paper Select

Choose the tray containing the paper you wish to copy onto: Paper Tray, Bypass Tray or large capacity tray (LCT).

🔍 Reference

⇒ P.73 "Copying from the Bypass Tray".

💡 Limitation

- Auto Paper Select mode is intended for normal and recycled paper.
- If you set all the paper trays other than "No Display" or "Recycled Paper", you cannot use Auto Paper Select.

Note

- See the following table for possible copy paper sizes and directions with Auto Paper Select (when copying at a ratio of 100%):

Metric version

Where Original Is Set	Paper Size and Direction
Exposure glass	A3, B4, A4, B5, 8 ¹ / ₂ " × 13" *1
Document feeder	A3, B4, A4, B5, A5, B6, 11" × 17", 8 ¹ / ₂ " × 11", 8 ¹ / ₂ " × 13" *1, 8K, 16K

*1 You can select from 8¹/₂" × 13", 8¹/₄" × 13" and 8" × 13" with the User Tools (System Settings). See "<F/F4>Size Setting" in the System Settings manual.

Inch version

Where Original Is Set	Paper Size and Direction
Exposure glass	11" × 17", 8 ¹ / ₂ " × 14", 8 ¹ / ₂ " × 11"
Document feeder	A4, 11" × 17", 11" × 15", 8 ¹ / ₂ " × 14", 8 ¹ / ₂ " × 11", 8" × 10", 10" × 14", 5 ¹ / ₂ " × 8 ¹ / ₂ ", 8 ¹ / ₂ " × 13" *1

*1 You can select from 8¹/₂" × 13", 8¹/₄" × 13" and 8" × 13" with the User Tools (System Settings). See "<F/F4>Size Setting" in the System Settings manual.

- For some originals, the original size might not be detected correctly. See ⇒ P.21 "Sizes difficult to detect".
- When you set special paper, such as recycled paper, in the paper tray, you can have the kind of paper shown on the display. See "Special Paper Indication" in the System Settings manual.
- In Connect Copy mode, select the copy paper in the master unit.
 - We recommend that both units have the same paper settings. Only paper trays loaded with the paper of the same size, direction and type installed in both the master unit and sub-unit are available.
 - When you press the **[Connect]** key, only the paper trays that have the same settings in both units are displayed. Other trays are shown grayed out and cannot be selected.
 - If the multiple trays are available in Connect Copy mode, each unit selects the paper tray detected in each "Paper Tray Priority" setting. See "Paper Tray Priority" in the System Settings manual.
 - If the paper tray in use runs out of paper in the sub-unit, the paper tray that has the paper identical in size and different in direction is selected, and the original image is rotated (if "On (Rotate)" is selected in "Auto Tray Switching"). See "Auto Tray Switching" in the System Settings manual.

1 Select the copy paper.

Auto Paper Select

1 Make sure that the [Auto Paper Select] key is selected.

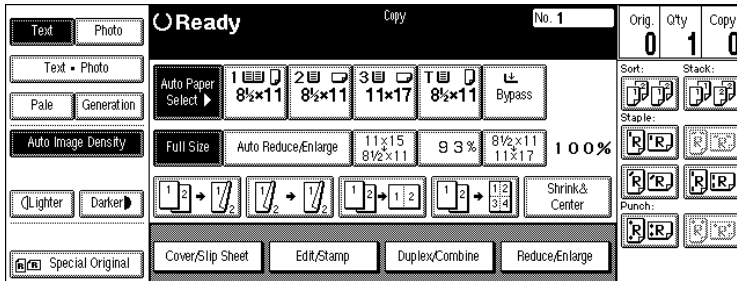

Note

- If the [Auto Paper Select] key is not selected, press the [Auto Paper Select] key.
- If you do not wish to set any other functions, press the [Start] key to start copying.

Manual Paper Select

1 Select the paper tray, bypass tray or large capacity tray (LCT).

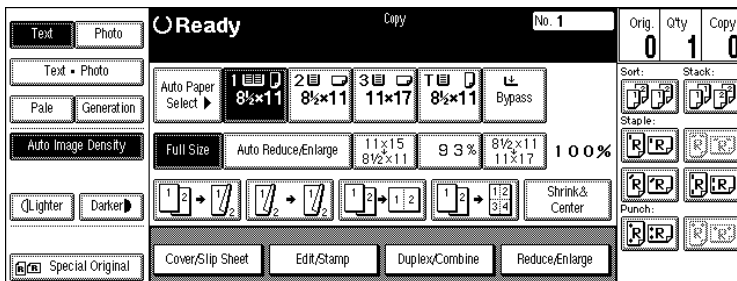

Note

- If you do not wish to set any other functions, press the [Start] key to start copying.

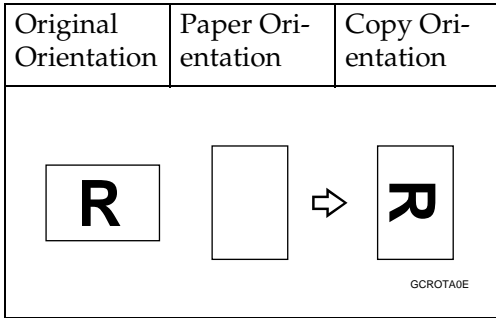

Rotated copy

If the direction in which your original is set (landscape or portrait) is different from that of the paper you are copying onto, this function rotates the original image by 90° and fits it on the copy paper. This function works when Auto Paper Select or Auto Reduce/Enlarge is selected. See “Auto Paper Select” in ⇒ P.43 “Selecting Copy Paper” and ⇒ P.47 “Auto Reduce/Enlarge”.

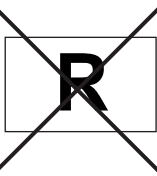

Limitation

- You cannot use the Rotated Copy function with Auto Paper Select if the “Auto Tray Switching” setting of the User Tools (System Settings) is set to “On (No Rotate)” or “No”. See “Auto Tray Switching” in the System Settings manual.
- You cannot use the Rotated Copy function when enlarging onto B4 or A3 size paper. In this case, set your original in the landscape direction.

	Original Size and Direction			Copy Paper Size and Direction	
You cannot rotate:	A4, B5, or A5 portrait	 GCROTAGE	When enlarging to →	B4, A3	 GCROTAGE
However, you can rotate:	A4, B5, or A5 landscape	 GCROTAGE	When enlarging to →	B4, A3	 GCROTAGE

- You cannot use the Rotated Copy function when “Top Slant”, “Left 2” or “Saddle Stitch” is selected for stapling or if the Punch function is selected. See ⇒ P.60 “Staple” and ⇒ P.69 “Punch”.

Auto Reduce/Enlarge

The machine can choose an appropriate reproduction ratio based on the paper and original sizes you select.

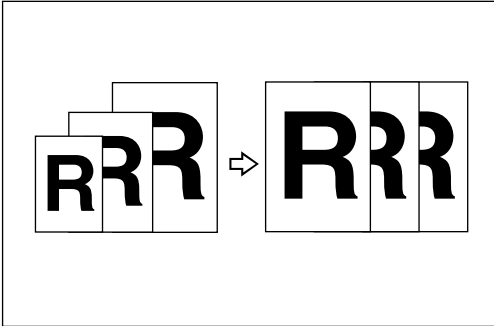

! Limitation

- You cannot use the bypass tray with this function.

📝 Note

- When you use Auto Reduce/Enlarge, see the following table for possible original sizes and directions:

❖ Metric version

Where Original Is Set	Original Size and Direction
Exposure glass	A3☐, B4☐, A4☐☐, B5☐☐, 8 ¹ / ₂ " × 13"☐ ^{*1} , 8K☐, 16K☐☐
Document feeder	A3☐, B4☐, A4☐☐, B5☐☐, A5☐☐, B6☐☐, 11" × 17"☐☐, 11" × 15"☐☐, 8 ¹ / ₂ " × 11"☐☐, 8 ¹ / ₂ " × 13"☐☐ ^{*1} , 8K☐, 16K☐☐

^{*1} You can select from 8¹/₂" × 13", 8¹/₄" × 13" and 8" × 13" with the User Tools (System Settings). See "<F/F4>Size Setting" in the System Settings manual.

❖ Inch version

Where Original Is Set	Original Size and Direction
Exposure glass	11" × 17"☐☐, 8 ¹ / ₂ " × 14"☐☐, 8 ¹ / ₂ " × 11"☐☐
Document feeder	A4☐☐, 11" × 17"☐☐, 11" × 15"☐☐, 8 ¹ / ₂ " × 14"☐☐, 8 ¹ / ₂ " × 11"☐☐, 5 ¹ / ₂ " × 8 ¹ / ₂ "☐☐, 8 ¹ / ₂ " × 13"☐☐ ^{*1}

^{*1} You can select from 8¹/₂" × 13", 8¹/₄" × 13" and 8" × 13" with the User Tools (System Settings). See "<F/F4>Size Setting" in the System Settings manual.

- The reproduction ratios the machine will select are 25 – 400%.

- For some originals, the original size might not be detected correctly. See ⇒ P.21 “*Sizes difficult to detect*”.
- You can set originals of different sizes in the document feeder at a time. See ⇒ P.37 “*Mixed Sizes mode*”.

1 Press the [Auto Reduce/Enlarge] key.

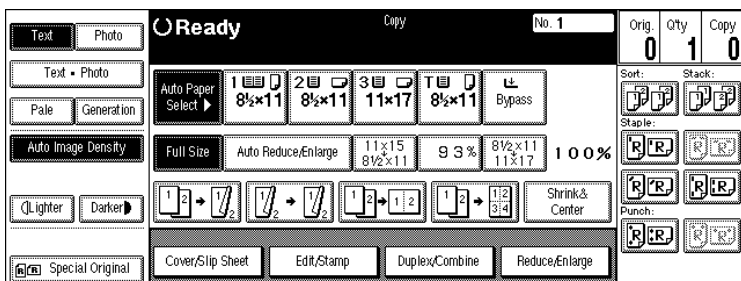

2 Select the paper tray.

Note

- If you do not wish to set any other functions, press the [Start] key to start copying.

Copying onto Tab Stock

The options which are required to use this function are as follows:

- Output tray or 100-sheet finisher
- Tab sheet tray

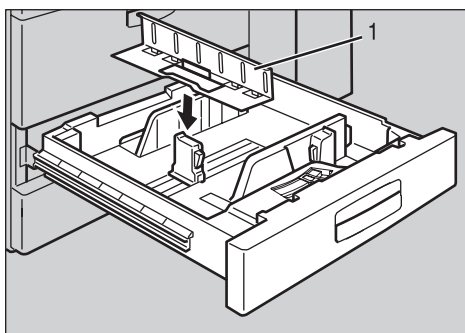

1. Tab sheet tray

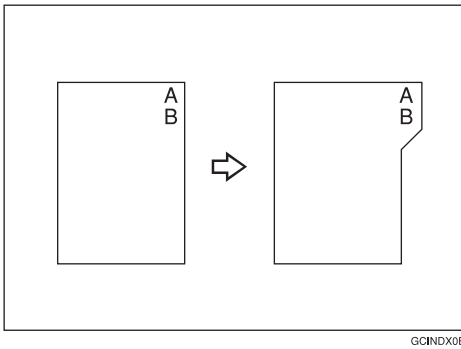

To make copies onto tab stock, you need to specify the paper type. For details, see “Tray 2: Special Paper Indication” in the System Settings manual.



Preparation

Select “Tab Stock” in “Tray 2: Special Paper Indication” of the User Tools (System Settings). See “Tray 2: Special Paper Indication” in the System Settings manual.

Specify the paper size in “Tray 2: Paper Size Setting” of the User Tools (System Settings) as follows:

- Metric version: A4 
- Inch version: $8\frac{1}{2}'' \times 11''$ 

Set the tab stock in tray 2.

Check the position of the index tab to avoid cropping the image. See “Tray 2: Special Paper Indication” in the System Settings manual.

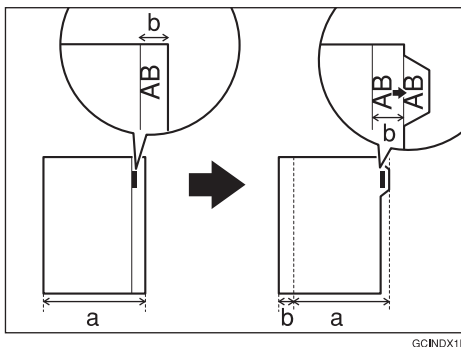

Limitation

- Use originals which contain only text.
- The image area of one original should be 6% or less of the whole area of the original.
- The font size of the letters on the originals should be 16 points or less.
- When using the tab stock, the temperature should be 20°C, 68°F or more.

Important

- Tab stock is always fed starting with the top tab.

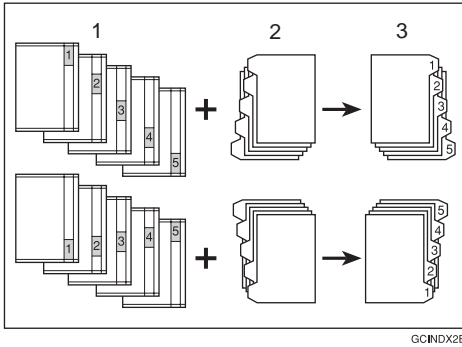

GCINDX2E

1. Set originals

2. Place the tab stocks in tray 2

3. Make copies

- Use the originals which do not have any images on the top or bottom part of the index tab. If the images are on the top or bottom part of the index, the images are not copied on the paper, and the machine will be damaged.

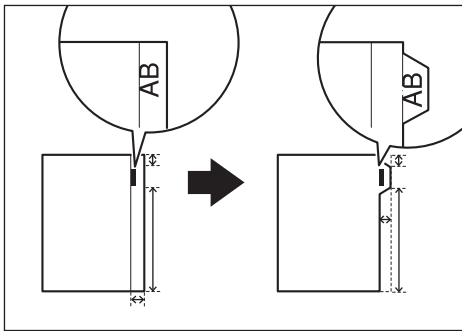

GCINDX6E

Note

- When copying onto the tab stock, copying speed will be reduced.
- Copies are delivered face down.
- The number of tabs, weights and types of the tab stock that can be placed in tray 2 are as follows:

	Number of Tabs	Weight of Tab Stock	Type of Tab Stock
Metric version	Tab 5	160g/m ² , 110 lb. Index or lighter	Small tab only (large tab is not available)
Inch version	Tab 1 – 5, Tab 8, Tab 12		

- You can store the optional tab sheet tray using the hook which is packed with the tab sheet tray.

1 Pull out tray 2 until it stops.

2 Adjust the back fence as follows:

- Metric version: 10" (Paper Size Settings is A4 )
- Inch version: B5 (Paper Size Settings is 8¹/₂" × 11" )

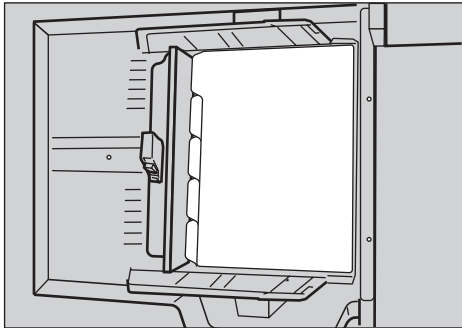
3 Attach the tab sheet tray to the back fence in the paper tray.**4** Place the tab stock in the  direction as shown below.**5** Select the paper tray (tray 2).**6** Place your originals as follows:

❖ Exposure glass

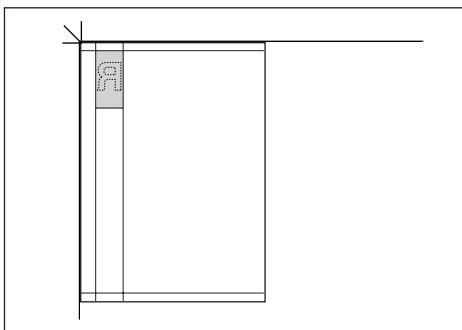

❖ Document feeder

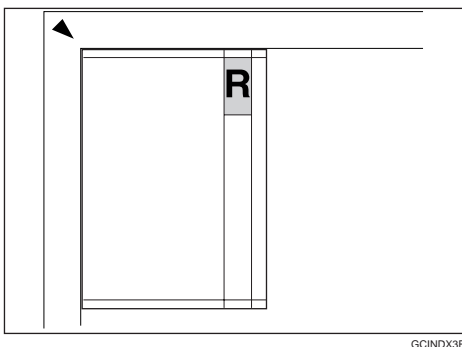
**7** Press the **[Start]** key.

Sort/Stack/Staple

The machine can scan your originals into memory and automatically sort the copies.

❖ Sort

- Sort
- Rotate Sort

❖ Stack (optional finisher required)

- Stack
(optional finisher required)

❖ Staple (optional finisher required)

50-Sheet/100-Sheet Finisher

- Top
 - Top Slant
 - Bottom
 - Left 2
 - Top 2 (only when “90° Turn” is selected with the original orientation)
- Booklet Finisher
- Top Slant
 - Bottom
 - Left 2
 - Top 2 (only when “90° Turn” is selected with the original orientation)
 - Saddle Stitch

⚠ Limitation

- ❑ You cannot use the bypass tray with this function.

📝 Note

- ❑ When the number of copies exceeds the tray capacity, remove copies from the tray.

- The maximum tray capacity is as follows.

❖ **Metric version**

Output tray	<ul style="list-style-type: none"> • A5, B5, A3: 250 sheets (80g/m²) • A4, B4: 500 sheets (80g/m²)
50-Sheet Finisher	Finisher proof tray (Without punch): <ul style="list-style-type: none"> • B4 or larger: 50 sheets (80g/m²) • A4 or smaller: 250 sheets (80g/m²)
	Finisher shift tray (Without punch): <ul style="list-style-type: none"> • A5□: 100 sheets (80g/m²) • Except A5□, A4□: 1,500 sheets (80g/m²) • A4□: 3,000 sheets (80g/m²)
100-Sheet Finisher	Finisher proof tray (Without punch): <ul style="list-style-type: none"> • B4 or larger: 250 sheets (80g/m²) • A4 or smaller: 500 sheets (80g/m²)
	Finisher shift tray (Without punch): <ul style="list-style-type: none"> • A5□: 100 sheets (80g/m²) • Except A5□, A4□: 1,500 sheets (80g/m²) • A4□: 3,000 sheets (80g/m²)
Booklet Finisher	Finisher proof tray: <ul style="list-style-type: none"> • A4□ or larger: 75 sheets (80g/m²) • A4□ or smaller: 150 sheets (80g/m²)
	Finisher shift tray (Without staple): *1 <ul style="list-style-type: none"> • Except A4□, B5□: 500 sheets (80g/m²) • A4□, B5□: 1,000 sheets (80g/m²)
	Booklet tray: <ul style="list-style-type: none"> • 1 – 5 sheets: 25 sets (80g/m²) • 6 – 10 sheets: 15 sets (80g/m²) • 11 – 15 sheets: 10 sets (80g/m²)

*1 If you copy when paper remains on the tray, the capacity might be reduced.

❖ **Inch version**

Output tray	<ul style="list-style-type: none"> • 5¹/₂" × 8¹/₂", 11" × 17": 250 sheets (20 lb. Bond) • 8¹/₂" × 11", 8¹/₂" × 13": 500 sheets (20 lb. Bond)
50-Sheet Finisher	<p>Finisher proof tray (Without punch):</p> <ul style="list-style-type: none"> • 8¹/₂" × 14" or larger: 50 sheets (20 lb. Bond) • 8¹/₂" × 11" or smaller: 250 sheets (20 lb. Bond)
	<p>Finisher shift tray (Without punch):</p> <ul style="list-style-type: none"> • 5¹/₂" × 8¹/₂" □: 100 sheets (20 lb. Bond) • Except 5¹/₂" × 8¹/₂" □, 8¹/₂" × 11" □: 1,500 sheets (20 lb. Bond) • 8¹/₂" × 11" □: 3,000 sheets (20 lb. Bond)
100-Sheet Finisher	<p>Finisher proof tray (Without punch):</p> <ul style="list-style-type: none"> • 8¹/₂" × 14" or larger: 250 sheets (20 lb. Bond) • 8¹/₂" × 11" or smaller: 500 sheets (20 lb. Bond)
	<p>Finisher shift tray (Without punch):</p> <ul style="list-style-type: none"> • 5¹/₂" × 8¹/₂" □: 100 sheets (20 lb. Bond) • Except 5¹/₂" × 8¹/₂" □, 8¹/₂" × 11" □: 1,500 sheets (20 lb. Bond) • 8¹/₂" × 11" □: 3,000 sheets (20 lb. Bond)
Booklet Finisher	<p>Finisher proof tray:</p> <ul style="list-style-type: none"> • 8¹/₂" × 11" □ or larger: 75 sheets (20 lb. Bond) • 8¹/₂" × 11" □ or smaller: 150 sheets (20 lb. Bond)
	<p>Finisher shift tray (Without staple): *1</p> <ul style="list-style-type: none"> • Except 8¹/₂" × 11" □: 500 sheets (20 lb. Bond) • 8¹/₂" × 11" □: 1,000 sheets (20 lb. Bond)
	<p>Booklet tray:</p> <ul style="list-style-type: none"> • 1 – 5 sheets: 25 sets (20 lb. Bond) • 6 – 10 sheets: 15 sets (20 lb. Bond) • 11 – 15 sheets: 10 sets (20 lb. Bond)

*1 If you copy when paper remains on the tray, the capacity might be reduced.

Sort

Copies can be assembled as sets in sequential order.

❖ Sort

Copies can be assembled as sets in sequential order.

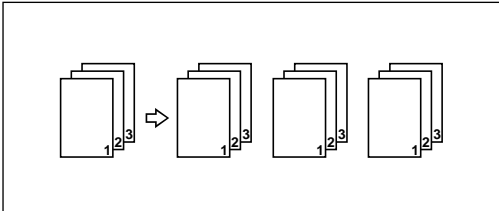

- 50-Sheet/100-Sheet Finisher

The shift tray moves backward or forward each time the copies of one set or those of each job are delivered, causing the next copy to shift when delivered so that you can differentiate each set or job.

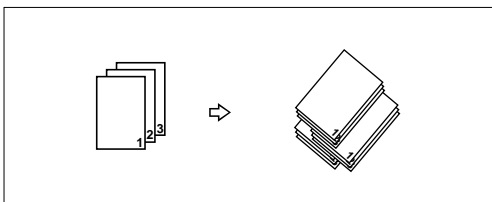

- Booklet Finisher

The shift tray moves backward or forward each time the copies of one set or those of each job are delivered, causing the top sheet of each set to shift when delivered so that you can differentiate each set or job.

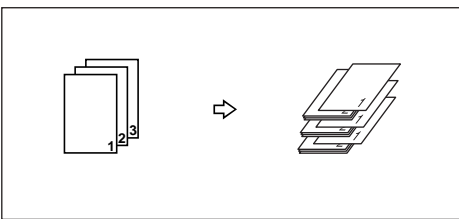

GCANS01E

Note

The paper sizes that can be used in the Sort function are as follows:

❖ Metric version

Output tray	A3, B4, A4, B5, 8K, 16K
50-Sheet Finisher	A3, B4, A4, B5, A5
100-Sheet Finisher	A3, B4, A4, B5, A5
Booklet Finisher	A3, B4, A4, B5

❖ **Inch version**

Output tray	11" × 17" ☐☐, 8 ¹ / ₂ " × 14" ☐☐, 8 ¹ / ₂ " × 11" ☐☐
50-Sheet Finisher	11" × 17" ☐☐, 8 ¹ / ₂ " × 14" ☐☐, 8 ¹ / ₂ " × 11" ☐☐
100-Sheet Finisher	11" × 17" ☐☐, 8 ¹ / ₂ " × 14" ☐☐, 8 ¹ / ₂ " × 11" ☐☐☐, 5 ¹ / ₂ " × 8 ¹ / ₂ " ☐☐☐
Booklet Finisher	11" × 17" ☐☐, 8 ¹ / ₂ " × 14" ☐☐, 8 ¹ / ₂ " × 11" ☐☐

❖ **Rotate Sort**

Every other copy set is rotated by 90° ☐☐ and delivered to the copy tray.

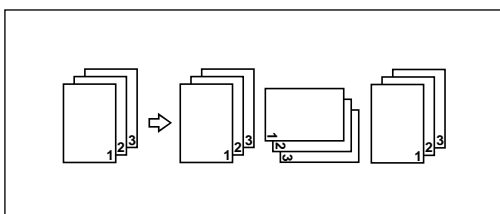

Note

- ☐ When the optional finisher is installed, you can switch to or from the Rotate Sort function with the User Tools. See “Select Stack or Rotate sort” in ⇒ P.329 “Input/Output”.
- ☐ The paper sizes that can be used in the Rotate Sort function are as follows:

❖ **Metric version**

Output tray	A4 ☐☐, B5 ☐☐, A5 ☐☐, 8 ¹ / ₂ " × 11" ☐☐, 8K ☐, 16K ☐☐
50-Sheet Finisher	A4 ☐☐, B5 ☐☐, A5 ☐☐
100-Sheet Finisher	A4 ☐☐, B5 ☐☐, A5 ☐☐
Booklet Finisher	A4 ☐☐, B5 ☐☐

❖ **Inch version**

Output tray	8 ¹ / ₂ " × 11" ☐☐
50-Sheet Finisher	8 ¹ / ₂ " × 11" ☐☐
100-Sheet Finisher	8 ¹ / ₂ " × 11" ☐☐
Booklet Finisher	8 ¹ / ₂ " × 11" ☐☐

- ☐ To use the Rotate Sort function, two paper trays identical in size and different in direction (☐☐) are required.

Reference

For the paper capacity of the optional finishers, see ⇒ P.344 “50-Sheet Finisher”, ⇒ P.346 “100-Sheet Finisher” and ⇒ P.348 “Booklet Finisher”.

1 Press the [Sort] or [Rotate Sort] key.

❖ When the finisher is not installed

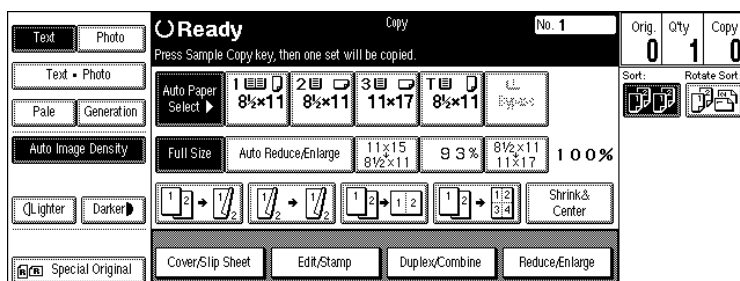

2

❖ When the 50-Sheet/100-Sheet Finisher is installed

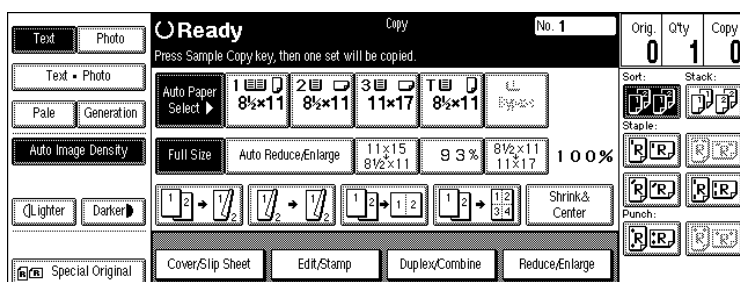

❖ When the booklet finisher is installed

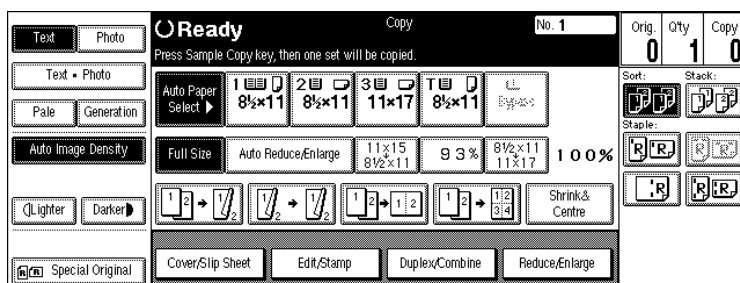

 **Note**

- When the optional finisher is installed, use the User Tools to display [Rotate Sort]. See “Select Stack or Rotate sort” in ⇒ P.329 “Input/Output”.

2 Enter the number of copy sets with the number keys.

 **Limitation**

- The maximum number of sets is 999.

 **Note**

- To change the entered number, press the [Clear/Stop] key.

3 Set your originals, then press the [Start] key.

When setting a stack of originals in the document feeder

- 1 Set a stack of originals in the document feeder, then press the **[Start]** key.

After all the originals are scanned, the copies are delivered to the tray.

 **Note**

- The last page should be on the bottom.
 - If an original is misfed during sorted copying, reset your originals in the document feeder according to the instructions on the display. The display will indicate the number of scanned originals.
-

When setting an original on the exposure glass or in the document feeder using Batch (SADF) mode

 **Reference**

⇒ P.36 “Batch (SADF) mode”.

- 1 Set the original, then press the **[Start]** key.

 **Note**

- Start with the first page to be copied.

- 2 Set the next original. When it is placed on the exposure glass, press the **[Start]** key.

 **Note**

- Set the original in the same direction as the first one.

- 3 After all originals are scanned, press the **[#]** key.
-

Stack

The optional finisher is required to use this function.

❖ **Stack**

This function groups copies of each page in a multi-page original together. Every other page stack is shifted for ease of separation. The finisher shift tray of the finisher provides this function by sliding from side to side.

- 50-Sheet/100-Sheet Finisher

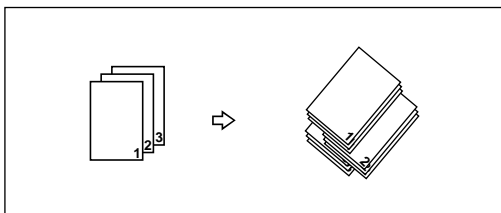

- Booklet Finisher

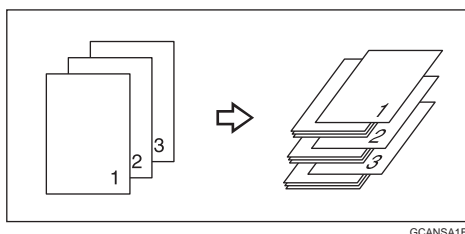

GCANSA1E

2

Note

The paper sizes that can be used in the Stack function are as follows:

❖ **Metric version**

50-Sheet Finisher	A3 <input type="checkbox"/> , B4 <input type="checkbox"/> , A4 <input type="checkbox"/> <input type="checkbox"/> , B5 <input type="checkbox"/> <input type="checkbox"/> , A5 <input type="checkbox"/> <input type="checkbox"/>
100-Sheet Finisher	A3 <input type="checkbox"/> , B4 <input type="checkbox"/> , A4 <input type="checkbox"/> <input type="checkbox"/> , B5 <input type="checkbox"/> <input type="checkbox"/> , A5 <input type="checkbox"/> <input type="checkbox"/> , 8K <input type="checkbox"/> , 16K <input type="checkbox"/> <input type="checkbox"/>
Booklet Finisher	A3 <input type="checkbox"/> , B4 <input type="checkbox"/> , A4 <input type="checkbox"/> <input type="checkbox"/> , B5 <input type="checkbox"/>

❖ **Inch version**

50-Sheet Finisher	11" × 17" <input type="checkbox"/> , 8 ¹ / ₂ " × 14" <input type="checkbox"/> , 8 ¹ / ₂ " × 11" <input type="checkbox"/> <input type="checkbox"/>
100-Sheet Finisher	11" × 17" <input type="checkbox"/> , 8 ¹ / ₂ " × 14" <input type="checkbox"/> , 8 ¹ / ₂ " × 11" <input type="checkbox"/> <input type="checkbox"/> , 5 ¹ / ₂ " × 8 ¹ / ₂ " <input type="checkbox"/> <input type="checkbox"/>
Booklet Finisher	11" × 17" <input type="checkbox"/> , 8 ¹ / ₂ " × 14" <input type="checkbox"/> , 8 ¹ / ₂ " × 11" <input type="checkbox"/> <input type="checkbox"/>

Reference

For the maximum tray capacity of the optional finisher, see ⇒ P.344 "50-Sheet Finisher", ⇒ P.346 "100-Sheet Finisher", and ⇒ P.348 "Booklet Finisher".

1 Press the [Stack] key.

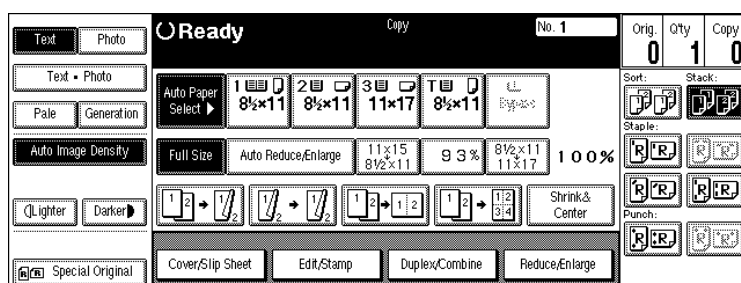

2 Enter the number of copies with the number keys.

Note

To change the entered number, press the [Clear/Stop] key.

3 Set your originals, then press the [Start] key.

When setting a stack of originals in the document feeder

- 1 Set a stack of originals in the document feeder, then press the **[Start]** key.

After all the originals are scanned, the copies are delivered to the tray.

 **Note**

- The last page should be on the bottom.
-

When setting an original on the exposure glass or in the document feeder using Batch (SADF) mode

 **Reference**

⇒ P.36 “Batch (SADF) mode”.

- 1 Set the original, then press the **[Start]** key.

 **Note**

- Start with the first page to be copied.

- 2 Set the next original. When it is placed on the exposure glass, press the **[Start]** key.

 **Note**

- Set the original in the same direction as the first one.
-

Staple

The optional finisher is required to use this function.

Each copy set can be stapled together.

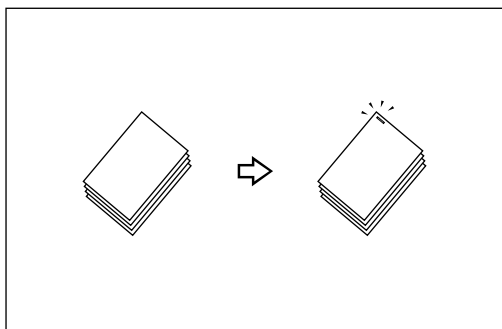

 **Limitation**

- You cannot use the following paper in this function:
 - Tab stocks
 - Postcards
 - Translucent paper

- OHP transparencies
- Adhesive labels
- Curled paper
- Low stiffness paper
- Paper of different vertical sizes

Note

- For this mode, the following limitation applies. When the number of copies exceeds the tray capacity, copying stops. In this case, remove the copies from the shift tray and then resume copying.

❖ Metric version



















	With 50-Sheet Finisher	With 100-Sheet Finisher	With Booklet Finisher
Paper size	A3□, B4□, A4□□, B5□□, 8K□, 16K□□	A3□, B4□, A4□□, B5□□, 8K□, 16K□□	A3□, B4□, A4□(□) ^{*3} , B5□ Saddle stitch function: A3□, B4□, A4□
Stapler capacity	(without punch) <ul style="list-style-type: none"> • A4 or smaller: 50 sheets (80g/m²) • B4 or larger: 30 sheets (80g/m²) 	(without punch) <ul style="list-style-type: none"> • A4□, B5□: 100 sheets (80g/m²) • Except A4□, B5□: 50 sheets (80g/m²) 	<ul style="list-style-type: none"> • A4□ or smaller: 50 sheets (80g/m²) • A4□ or larger: 30 sheets (80g/m²) • Saddle stitch function: 15 sheets (80g/m²)
Shift tray capacity (A4□) ^{*1}	3,000 sheets (80g/m ²)	3,000 sheets (80g/m ²)	750 sheets (80g/m ²) ^{*2}

^{*1} Depending on the number of sheets to be stapled and whether sheets have punched holes or not, the maximum tray capacity might be reduced.

^{*2} If you copy when the paper remains on the tray, the capacity might be reduced.

^{*3} Available staple positions are "Top" and "Bottom".

❖ **Inch version**

	With 50-Sheet Finisher	With 100-Sheet Finisher	With Booklet Finisher
Paper size	11" × 17"  , 8 1/2" × 14"  , 8 1/2" × 11"  	11" × 17"  , 8 1/2" × 14"  , 8 1/2" × 11"  	11" × 17"  , 8 1/2" × 11"   ^{*3} Saddle stitch function: 11" × 17"  , 8 1/2" × 11" 
Stapler capacity	(without punch) <ul style="list-style-type: none"> • 8 1/2" × 11" or smaller: 50 sheets (20 lb. Bond) • 8 1/2" × 14" or larger: 30 sheets (20 lb. Bond) 	(without punch) <ul style="list-style-type: none"> • 8 1/2" × 11" : 100 sheets (20 lb. Bond) • Except 8 1/2" × 11" : 50 sheets (20 lb. Bond) 	<ul style="list-style-type: none"> • 8 1/2" × 11"  or smaller: 50 sheets (20 lb. Bond) • 8 1/2" × 11"  or larger: 30 sheets (20 lb. Bond) • Saddle stitch function: 15 sheets (20 lb. Bond)
Shift tray capacity (8 1/2" × 11" ) ^{*1}	3,000 sheets (20 lb. Bond)	3,000 sheets (20 lb. Bond)	750 sheets (20 lb. Bond) ^{*2}

^{*1} Depending on the number of sheets to be stapled and whether sheets have punched holes or not, the maximum tray capacity might be reduced.

^{*2} If you copy when the paper remains on the tray, the capacity might be reduced.

^{*3} Available staple positions are "Top" and "Bottom".

- In the following cases, the copies will be delivered to the shift tray without stapling.
 - When the number of sheets for one set is over the stapler capacity.
 - When memory reaches 0% during copying.
- When you select Staple, Sort mode is automatically selected.

 **Reference**





























If you want to add staples, see ⇒ P.285 " Adding Staples".







When staple is jammed, see ⇒ P.293 " Removing Jammed Staples".

Stapling position and original setting

When there is copy paper that is identical in size and direction as your original, stapling positions are as follows:

◆ 50-Sheet /100-Sheet Finisher

		Original setting		Stapling position
		Exposure glass	Document Feeder	
 STAPLEAE	Top			
				
*1  STAPLEBE	Top Slant			
				
 STAPLECE	Bottom	 STAPLE25	 STAPLE26	 STAPLE27
		 STAPLE28	 STAPLE29	 STAPLE30
*1  STAPLEDE	Left 2			
		 STAPLE31	 STAPLE32	 STAPLE33

 STAPLEEE	Top 2	 STAPLE22	 STAPLE23	 STAPLE24
		 STAPLE10	 STAPLE14	 STAPLE20

*1 Original images are not rotated. When selecting these stapling positions, set the originals in the same direction as copy paper is set.

*2 This position is available if "90° Turn" is selected with the original orientation.







Note

























- You cannot change stapling positions during copying.
- When the original image is rotated, the stapling direction turns by 90°.
- With "Top" or "Bottom" selected at the stapling position, if no paper oriented in the same direction as the original is available, the image will be rotated and the paper of the same size as the original but oriented in the different direction will be selected.
- The maximum original image size that can be rotated is as follows:

Metric version	A4
Inch version	8 ¹ / ₂ " × 11"

- You cannot use the Rotated Copy function when "Top Slant" or "Left 2" is selected.

◆ Booklet Finisher



		Original setting		Stapling position
		Exposure glass	Document Feeder	
 STAPLEBE	Top Slant			
				

 STAPLECE	Bottom	 STAPLE25	 STAPLE26	 STAPLE27
		 STAPLE28	 STAPLE29	 STAPLE30
*1  STAPLEDE	Left 2	 STAPLE31	 STAPLE32	 STAPLE33
		 STAPLE31	 STAPLE32	 STAPLE33
*2  STAPLEEE	Top 2	 STAPLE22	 STAPLE23	 STAPLE24
		 STAPLE10	 STAPLE14	 STAPLE20
 STAPLEFE	Saddle Stitch	 STAPLE34	 STAPLE35	 STAPLE36

*1 Original images are not rotated. When selecting these stapling positions, set the originals in the same direction as copy paper is set.

*2 This position is available if "90° Turn" is selected with the original orientation.

Note

- If you select "Top Slant" when using A4 , 8¹/₂" × 11"  or 8¹/₂" × 14"  copy paper, the result will be "Top".
- If you select "Left 2", the machine will not rotate the image by 90°.

- ❑ If you select “Saddle Stitch”, the machine staples and folds the paper in the center, then delivers the paper folded.
- ❑ If you select “Saddle Stitch” in Magazine mode, the machine staples the paper, and folds it like a book, then delivers the paper folded. See ⇒ P.147 “Magazine”.

1 Select one of the stapling positions.

2

❖ 50-Sheet/100-Sheet Finisher

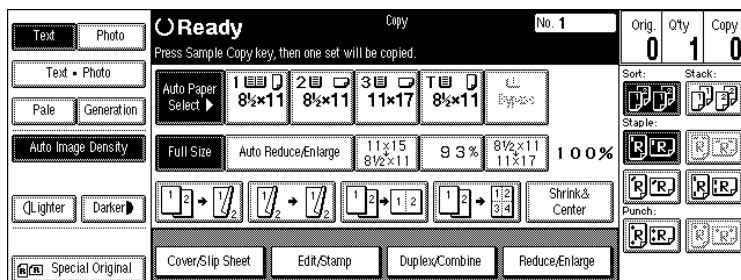

❖ Booklet Finisher

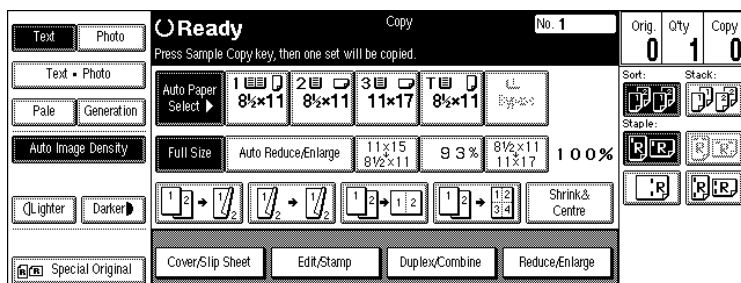

Note

- ❑ If the number of sheets of one set exceeds 15 when using “Saddle Stitch”, the message asking you if you wish to “Print” or “Cancel” the job appears. If you press the **[Print]** key, the booklet finisher staples 15 sheets as one set. If you press the **[Cancel]** key, stapling is canceled and you need to remove the paper remaining in the staple unit.
- ❑ When you select the stapling position, Sort mode is automatically selected.

Reference

⇒ P.63 “Stapling position and original setting”

2 Enter the number of copy sets with the number keys.

Note

- ❑ To change the entered number, press the **[Clear/Stop]** key.

3 Set your originals, then press the **[Start]** key.

When setting a stack of originals in the document feeder

1 Set a stack of originals in the document feeder, then press the **[Start]** key.

After all the originals are scanned, the copies are delivered to the tray.

Note

- The last page should be on the bottom.
-

When setting an original on the exposure glass or in the document feeder using Batch (SADF) mode

Reference

⇒ P.36 “Batch (SADF) mode”.

1 Set the original, then press the **[Start]** key.

Note

- Start with the first page to be copied.

2 Set the next original. When it is placed on the exposure glass, press the **[Start]** key.

Note

- Set the original in the same direction as the first one.

3 After all originals are scanned, press the **[#]** key.

To Stop Scanning Temporarily

When you are using the Sort, Stack, or Staple function, the originals are scanned into memory.

1 Press the **[Clear/Stop]** key to stop originals from being scanned into memory.

To resume scanning

1 Press the **[Resume]** key to resume scanning.

Note

- Scanned images in memory are not cleared.
-

To clear scanned images of the originals

1 Press the **[Cancel]** key.

Scanning is stopped with the images cleared.

When Memory Reaches 0%

Scanning will be stopped if the size of scanned image data exceeds memory capacity.

Note

- There is enough memory to store approximate 200 to 1,000 originals of A4, 8¹/₂" × 11" size. The number of originals that can be stored in memory varies depending on the memory setting and original type.

Reference

Scanning will stop when memory reaches 0% during sorted copying. However, you can change this setting so that all the scanned pages are copied and delivered to the tray first, then the machine automatically continues scanning the remaining originals. See "Memory Full Auto Scan Restart" in ⇒ P.329 "Input/Output".

1 Press the **[Start]** key.

The scanned pages are delivered to the tray. Then, the image data in memory is cleared.

2 Remove the copies and continue copying by following the instructions on the display.

To Remove the Paper from the Staple Unit

If you cancel the stapling copy job in the middle of the job, the paper might be left in the staple unit. In this case, remove the paper from the staple unit.

1 Press the **[Clear Modes/Energy Saver]** key to cancel the copy settings.

2 Set the next original, then press the **[Start]** key.

The paper left in the staple unit is automatically delivered, then the next job starts.

Note

- When the paper is not delivered and the message is displayed, follow the instructions on the display to remove the paper.

Punch

The optional finisher and punch kit are required to use this function.

This function is used to make punch holes in copies.

❖ 2 holes

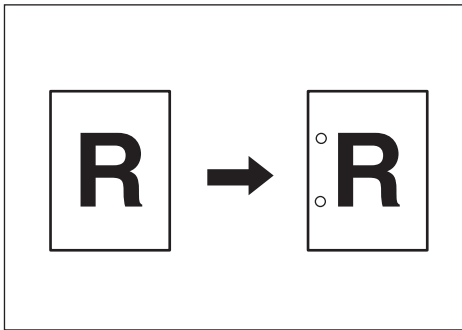

GCPNCH1E

❖ 3 holes

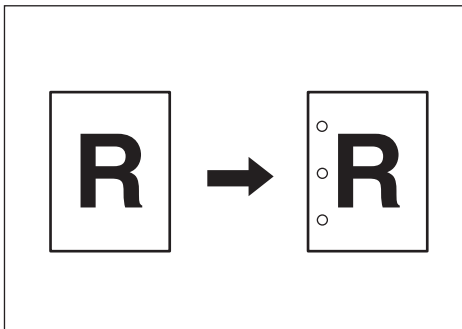

GCPNCH3E

❖ 4 holes

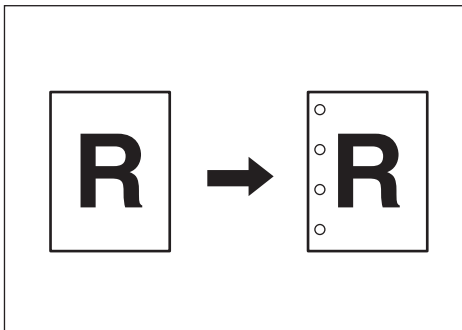

















































GCPNCH0E

Note























- ❑ The relationship between the direction in which you set the original and the punch hole positions is as follows:



❖ Punch hole positions

		Direction in which Original Is Set		Punch Hole Positions	
		Exposure glass	Document feeder		
Standard	2 holes				
					
	3 holes				
					
	4 holes				
					

90° Turn	2 holes				
					
	3 holes				
					
	4 holes				
					

 Punchable paper sizes are as follows:

2 holes		A3  – A5   , 11" × 17"  , 8 ¹ / ₂ " × 14"  – 5 ¹ / ₂ " × 8 ¹ / ₂ "  
3 holes		A3  , B4  , A4  , B5  , 11" × 17"  , 8 ¹ / ₂ " × 11" 
4 holes	Metric version	A3  , A4  , 11" × 17"  , 8 ¹ / ₂ " × 11" 
	Scandinavian version	A3  – A5  , 11" × 17"  , 8 ¹ / ₂ " × 14"  – 5 ¹ / ₂ " × 8 ¹ / ₂ "  

-  Since punch holes are made in each copy, the punch hole positions vary slightly.
-  The punch hole positions change according to the direction of the paper selected.

Reference

If the punch waste box fills up, see ⇒ P.301 " Removing Punch Waste".

1 Select the Punch position.

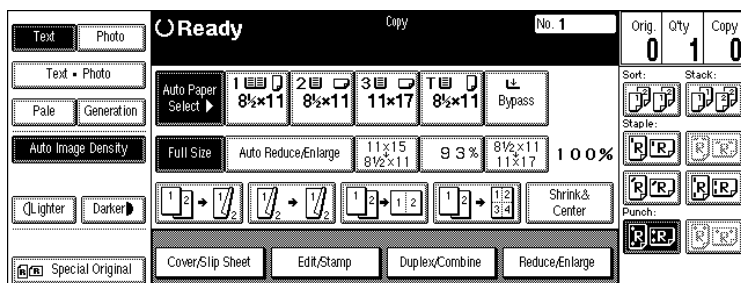

Note

- When stapling copies, also select a stapling position. See ⇒ P.60 “Staple”.

2 Enter the number of copy sets with the number keys.

Note

- To change the entered number, press the **[Clear/Stop]** key.
- If you wish to use the Sort function, press the **[Sort]** key.

3 Set your originals, then press the **[Start]** key.

Copying from the Bypass Tray

Use the bypass tray to copy onto OHP transparencies, adhesive labels, translucent paper, postcards, and copy paper that cannot be set in the paper tray.

Limitation

- When copying several originals using the bypass tray, copies are delivered face up (“Face Up Exit”) and in reverse order by default.
- You can change the setting to “Face Down Exit” only when you are using high quality copy paper with a weight of 52 – 105g/m² (14 – 28 lb. Bond). See “Face-Up/Down Selection in Bypass Mode” in ⇒ P.331 “Count Manager”.
- If you have copies delivered face down when copying onto special paper, such as adhesive labels, a paper misfeed may occur. Be sure to select “Face Up Exit”.

Note

- If you wish to have copies delivered face down when only one original is set on the exposure glass or in the document feeder, you must set the “Face-Up/Down Selection in Bypass Mode” setting to “Face Down Exit” and the “Face-Up/Down Selection in Platen Mode” setting to “Face Down Exit” with the User Tools. See “Face-Up/Down Selection in Bypass Mode” in ⇒ P.331 “Count Manager” and “Face-Up/Down Selection in Platen Mode” in ⇒ P.329 “Input/Output”.
- The machine can automatically detect the following sizes as standard size copy paper:

Metric version	A3, A4, A5
Inch version	A3, 11" × 17", 8 ¹ / ₂ " × 14", 8 ¹ / ₂ " × 11", 8" × 10 ¹ / ₂ ", 8" × 10", 5 ¹ / ₂ " × 8 ¹ / ₂ "

- If you do not use the standard size copy paper, you should input vertical and horizontal dimensions. The sizes that you can input are as follows:

Metric version	<ul style="list-style-type: none"> • Vertical: 100 – 300mm • Horizontal: 140 – 432mm
Inch version	<ul style="list-style-type: none"> • Vertical: 4.0" – 11.7" • Horizontal: 5.6" – 17.0"

- To make copies onto OHP transparencies or thick paper exceeding 105g/m², 28 lb. Bond, specify the paper type in ⇒ P.76 “When Copying onto OHP Transparencies or Thick Paper”.
- The maximum number of sheets you can set at a time depends on the paper type. For details about paper capacity of the bypass tray, see ⇒ P.23 “Copy Paper”.

- In Connect Copy mode, you can set only cover sheet paper and slip sheet paper for the Cover/Slip Sheet function in the bypass tray.

1 Open the bypass tray.

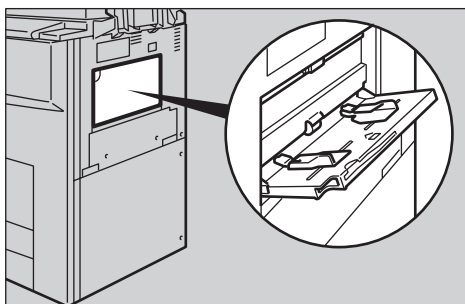

ZBQH050E

2 Adjust the guides to copy paper size.

Important

- If the guides are not flush with the copy paper, a skew image or paper misfeeds might occur.

3 Lightly insert the copy paper face up until the beeper sounds.

The  indicator on the display automatically goes on.

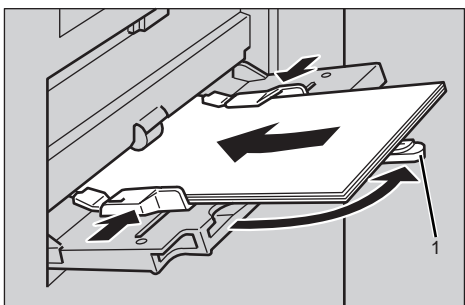

ZBQH040E

1. Extender

Note

- The face side of the paper set is copied on.
- Do not stack paper over the limit mark, otherwise a skew image or paper misfeeds might occur.
- If the beeper is turned off, lightly insert the copy paper until it stops. See "Operation Panel Beeper" in the System Settings manual.
- When the document feeder is open, set the direction of the copy paper to .

- Swing out the extender to support paper sizes larger than A4, 8¹/₂" × 11".
- Fan paper to get air between the sheets and avoid a multi-sheet feed.
- Before setting, adjust the paper if curled or warped.

When copying onto non-standard size paper

Important

- You should specify the size of copy paper to avoid paper misfeeds.

1 Press the [#] key.

2 Press the [Non Standard] key.

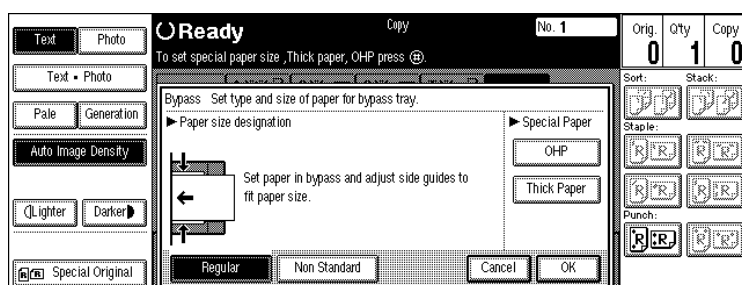

3 Press the [Vert inch] key and enter the vertical size of the paper with the number keys, then press the [#] key.

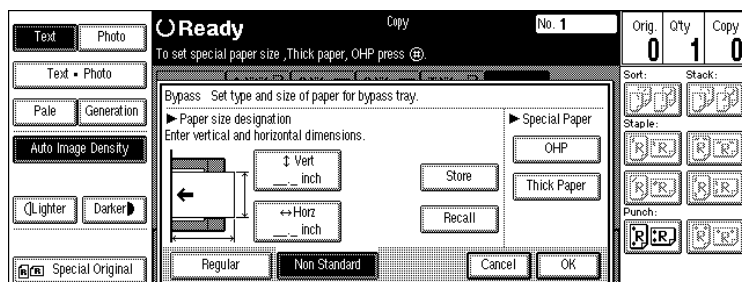

Note

- To change the number entered, press the [Clear] or [Clear/Stop] key and enter the new number.

4 Enter the horizontal size of the paper with the number keys, then press the [#] key.

Note

- If the [Horz inch] key is not highlighted, press the [Horz inch] key.
- To change the number entered, press the [Clear] or [Clear/Stop] key and enter the new number.

5 To register the non-standard size entered, press the [Store] key and then press the [Cancel] key.

 **Note**

- If you do not register the non-standard size, go to step 6.
- Only one non-standard size can be stored.
- To recall the non-standard size stored, press the **[Recall]** key.
- If you do not register the non-standard size, the size you set is deleted when modes are cleared.

6 Press the **[OK]** key.

4 Set your originals, then press the **[Start]** key.

5 When your copy job is finished, press the **[Clear Modes/Energy Saver]** key to clear the settings.

When Copying onto OHP Transparencies or Thick Paper

To make copies onto OHP transparencies or thick paper, you need to specify the paper type.

 **Limitation**

- When you select “OHP” or “Thick Paper”, copy paper is delivered face up even if you have set the “Face-Up/Down Selection in Bypass Mode” setting to “Face Down Exit”. See “Face-Up/Down Selection in Bypass Mode” in ⇒ P.331 “Count Manager”.

 **Note**

- Select **[Thick Paper]** if the paper weight is more than 105g/m², 28 lb. Bond.

1 Open the bypass tray, and adjust the guides to the paper size.

 **Important**

- If the guides are not flush with the copy paper, a skew image or paper misfeeds might occur.

2 Lightly insert the OHP transparencies or thick paper face up until the beeper sounds.

The  indicator on the display automatically goes on.

 **Note**

- When you set an OHP transparency, make sure that its front and back faces are properly positioned.
- To avoid paper misfeeds, fan the paper before setting it in the tray.

3 Press the **[#]** key.

4 Select [OHP] or [Thick Paper].

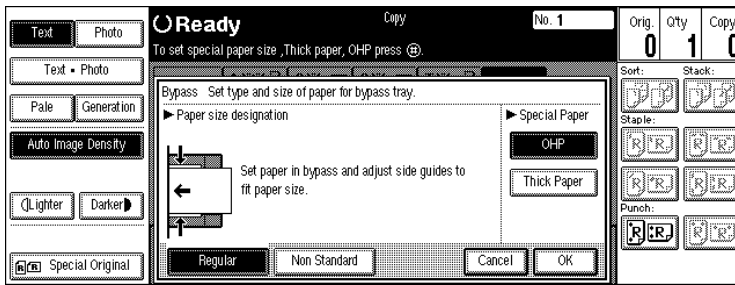

5 Press the [OK] key.

6 Set your originals and press the [Start] key.

Important

- When copying onto OHP transparencies, remove copied sheets one by one.

7 When your copy job is finished, press the [Clear Modes/Energy Saver] key to clear the settings.

Programs

You can store frequently used copy job settings in machine memory, and recall them for future use.

Limitation

- You cannot store the settings whether the Connect Copy function will be selected automatically in a program.

Storing Your Settings

You can store your settings you frequently use.

Deleting A Program

You can delete a stored program.

Recalling A Program

You can recall a stored program.

Note

- You can store up to ten programs.
- You can select the standard mode or program No. 10 as the mode to be set when modes are cleared or reset is made, or immediately after the operation switch is turned on. See “Initial Mode” in ⇒ P.313 “General Features ²/₃”.
- Paper settings are stored based on paper size. So if you place more than one paper tray of the same size, the paper tray prioritized with the User Tools (System Settings) will be selected first. See “Paper Tray Priority” in the System Settings manual.
- Programs are not cleared by turning the power off or by pressing the **[Clear Modes/Energy Saver]** key. They are canceled only when you delete or overwrite them with another program.
- If your program contains settings that are not available in Connect Copy mode, they are ignored in Connect Copy mode.
- If your program contains settings that are not available on the sub-unit, they are ignored in Connect Copy mode.

Storing a Program

- 1** Edit the copy settings so that all functions you want to store in this program are selected.

2 Press the **[Program]** key.

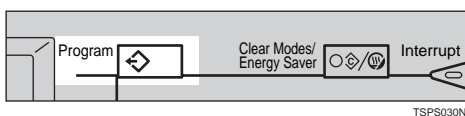

3 Press the **[Store]** key.

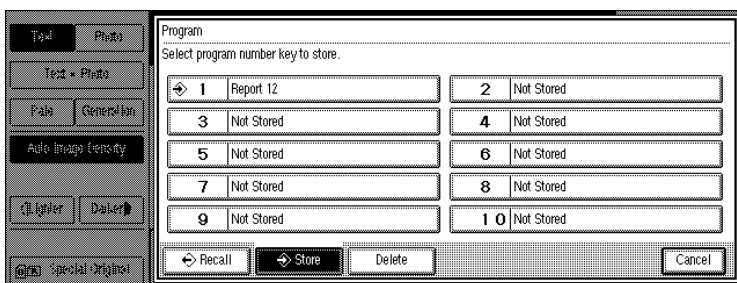

4 Press the program number you want to store.

Note

- Program numbers with already have settings in them.

Reference

⇒ P.80 "Changing a Stored Program"

5 Enter the program name with the letter keys on the display panel.

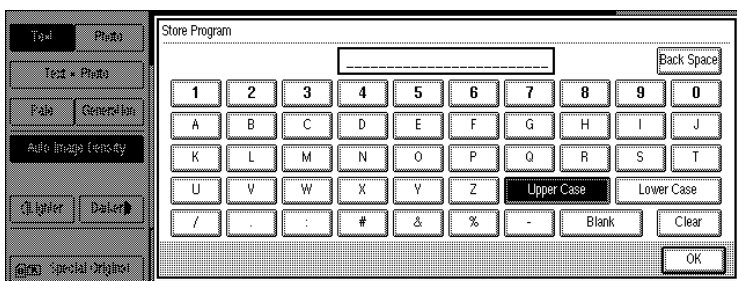

Note

- If you do not wish to enter the program name, go to step **6**.
- You can register up to 25 characters.
- To change the name entered, press the **[Back Space]**, **[Clear]** or **[Clear/Stop]** key and enter new letters.

6 Press the **[OK]** key.

When the settings are successfully stored, the indicator goes on.

Changing a Stored Program

1 Press the stored program number key and make sure the settings.

 **Note**

- When you want to check the contents of the program, recall the program.
See ⇒ P.81 “Recalling a Program”.

2 Repeat steps **1** to **4** in Storing a Program.

To overwrite the program

 **Important**

- If you select **[Delete]**, the previous program is lost.

1 Press the **[Delete]** key.

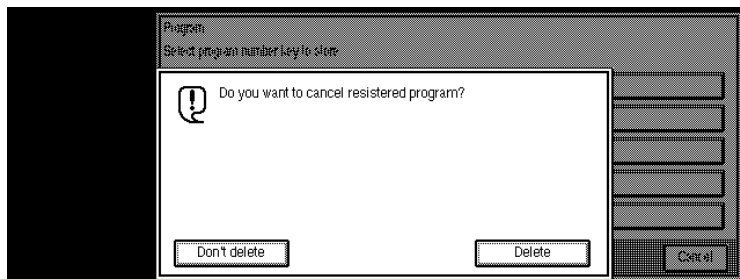

2 Repeat steps **5** and **6** in Storing a Program.

Not to overwrite the program

1 Press the **[Don't delete]** key.

Deleting a Program

1 Press the **[Program]** key.

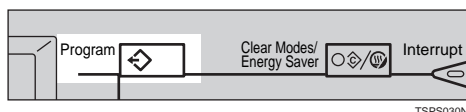

2 Press the [Delete] key.

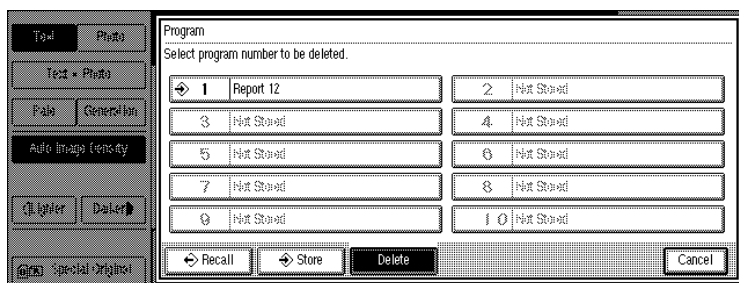

3 Press the program number you want to delete.

4 Press the [Delete] key.

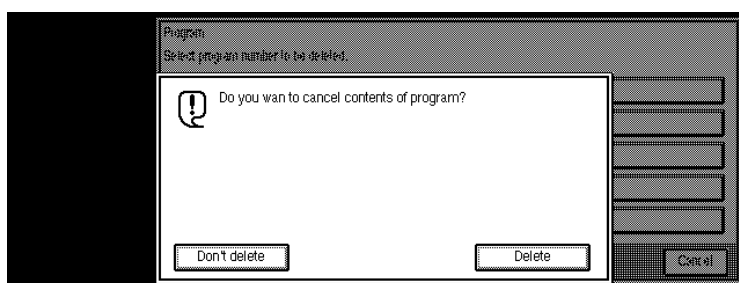

Note

To cancel the deletion, press the [Don't delete] key.

Recalling a Program

1 Press the [Program] key.

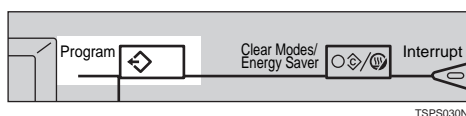

2 Press the [Recall] key.

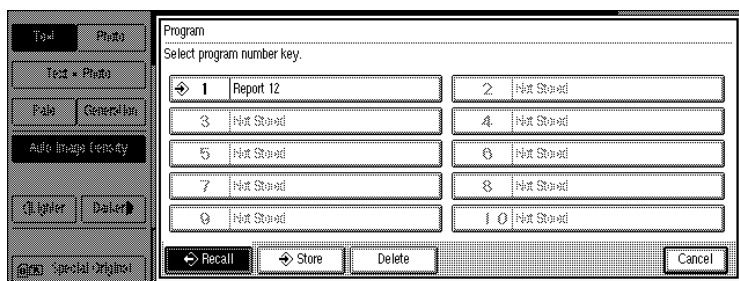

3 Press the program number you want to recall.

The stored settings are displayed.

 **Note**

Only programs with ⇄ contain a program.

4 Set your originals, then press the **[Start]** key.

2

Job Preset

If a long copy job is in progress and you do not wish to wait for it to finish, you can use this function to set up the next copy job in advance. When the current copy job is finished, your copy job will be started automatically.

⚠ Limitation

- You cannot combine the Job Preset function with the Connect Copy function (option).

📝 Note

- The maximum number of job sets that you can set with this function is 8.
- You can use this function for the documents stored in the Document Server.

1 Press the [Copy/New Job] key.

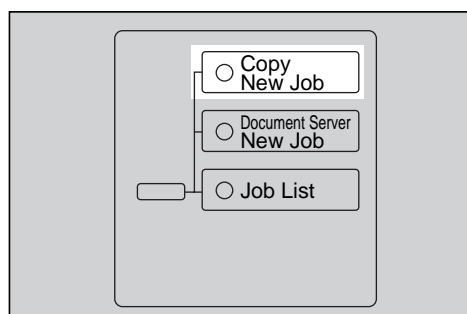
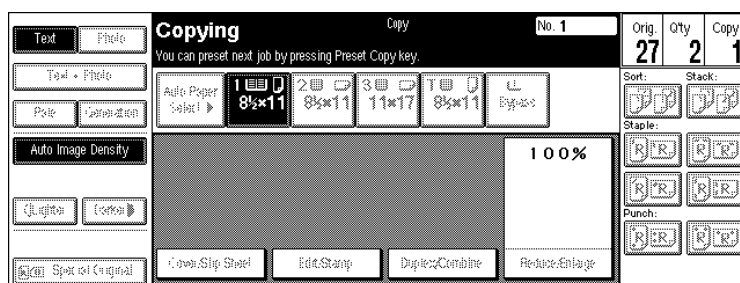

ZBQS080N

2 Set up the next copy job.

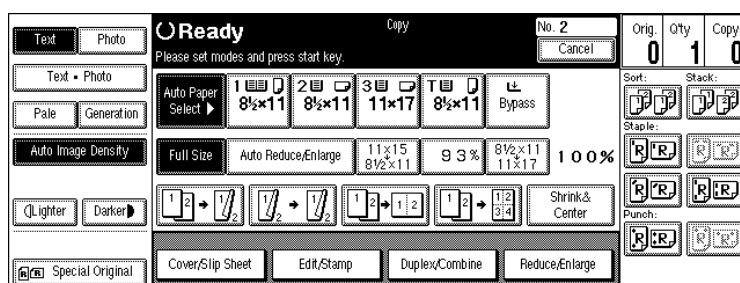

Note

- The receipt number (preset number) of the preset job is displayed on the upper right of the display panel.
- To cancel this job, press the **[Cancel]** key.

3 Set the originals in the document feeder and press the **[Start]** key.

After all originals are scanned, the Job List is displayed.

4 Press the **[Return to menu in printing]** key.

After the current copy job, the next job starts automatically.

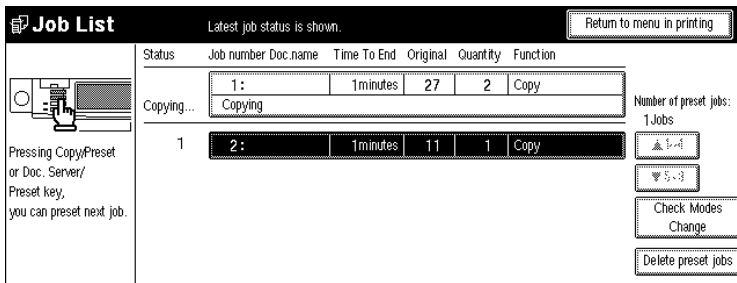

Note

- You can switch the display to the current copy job by pressing the **[Return to menu in printing]** or **[Return to menu in scanning]** key. You can switch the display to the preset job by pressing the **[Return to menu in setting new job]** key.

Editing Job Preset

1 Press the **[Job List]** key.

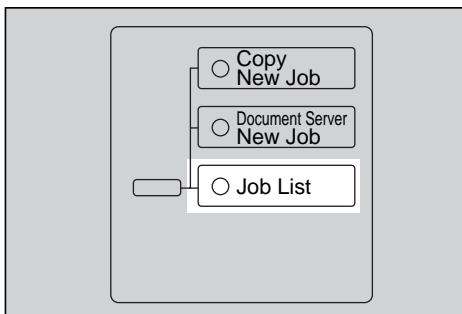

ZBQS090N

Note

- You can confirm the preset number, time to end, number of originals, number of copy sets, and functions you use in the job status list.

2 Press the preset job you want to change.

 **Note**

- If the desired job is not shown and more than 5 jobs are preset, press the [▼5~8] key to display the desired job.

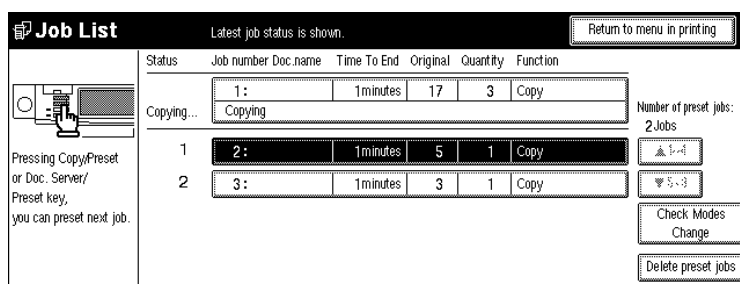

3 Press the [Check Modes//Change] key.

4 Change the settings.

5 Press the [Return to job status menu] key.

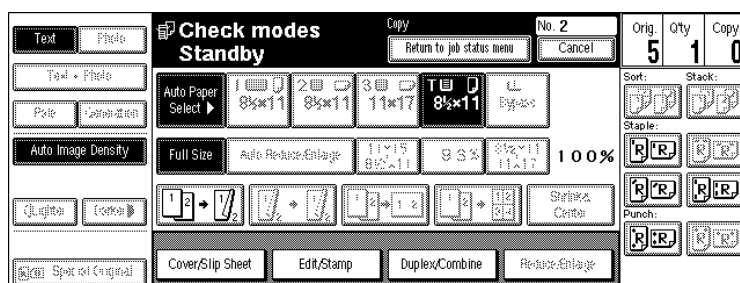

6 Press the [Yes] key.

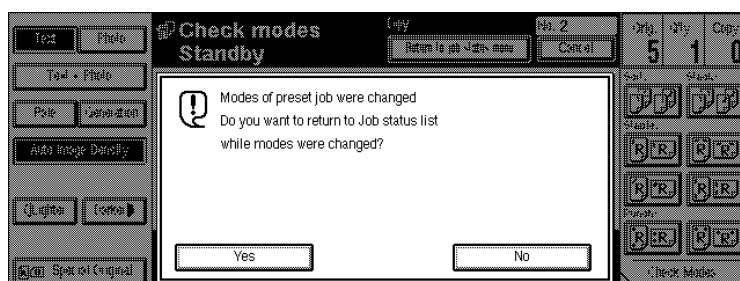

 **Note**

- To cancel the changes, press the [No] key.

7 If you want to change the settings for other preset jobs, repeat steps **2** to **6**.

8 Press the [Return to menu in printing] key.

The initial display reappears.

Note

- Depending on the condition of the current copy job, the **[Return to menu in setting new job]** or **[Return to menu in scanning]** key might be displayed. In this case, press the **[Return to menu in setting new job]** or **[Return to menu in scanning]** key.

2

Deleting Job Preset

You can delete the preset job in the Job List or Check modes display. The following procedure describes how to delete the preset job in the Job List display.

- 1 Press the **[Job List]** key.

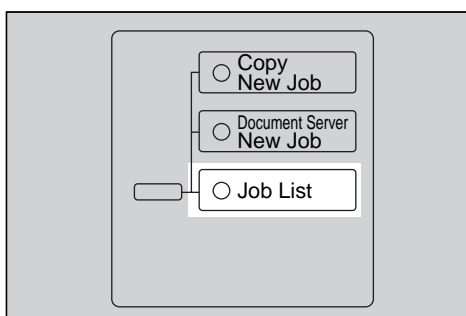

ZBQS090N

- 2 Press the preset job you want to delete, then press the **[Delete preset jobs]** key.

Job List

Latest job status is shown.

Return to menu in printing

Status	Job number	Doc name	Time To End	Original	Quantity	Function
Copying...	1:	Copying	1minutes	17	3	Copy
1	2:		1minutes	5	1	Copy
2	3:		1minutes	3	1	Copy

Number of preset jobs: 2 Jobs

Pressing Copy/Preset or Doc. Server/ Preset key, you can preset next job.

Check Modes Change

Delete preset jobs

Note

- If you delete the preset job in the Check modes display, press the **[Cancel]** key in the Check modes display.
- If the desired job is not shown and more than 5 jobs are preset, press the **[▼5~8]** key to display the desired job.

3 Press the [Cancel] key.

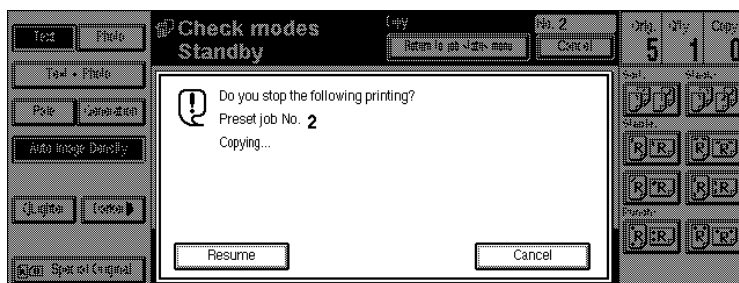

Note

- To cancel the deletion, press the [Resume] key.

4 If you want to delete other preset jobs, repeat steps **2** and **3**.

5 Press the [Return to menu in printing] key.

The initial display reappears.

Note

- Depending on the condition of the current copy job, the [Return to menu in preset mode] or [Return to menu in scanning] key might be displayed. In this case, press the [Return to menu in preset mode] or [Return to menu in scanning] key.

Other Functions

Energy Saver Mode

If you do not operate the machine for a certain period after copying, or when you press and hold the **[Clear Modes/Energy Saver]** key for more than one second, the display disappears and the machine enters Energy Saver mode. When you press the **[Clear Modes/Energy Saver]** key again, when the originals are set in the document feeder, or when the document feeder is opened, the machine returns to the ready condition. In Energy Saver mode, the machine uses less electricity.

Energy Saver mode makes a two-step reduction in electricity: one for the period up to the time set for Low Power mode, the other for the period after that time.

Note

- If you press the **[Clear Modes/Energy Saver]** key during the operation, the current settings will be cleared.
- It takes about 10 seconds to return to the ready condition from Energy Saver mode.
- It takes about 30 seconds to return to the ready condition from Low Power mode.
- If you press the **[Clear Modes/Energy Saver]** key while setting Connect Copy, Connect Copy mode is canceled and the machine returns to the initial condition of Copy mode.
- If you press the **[Connect]** key on the master unit, the sub-unit exits Energy Saver mode and enters Connect Copy mode.
- In Connect Copy mode, the sub-unit will not enter Energy Saver mode.

Reference

See “Low Power Timer” in the System Settings manual.

Interrupt Copy

Use this function if you wish to interrupt a long copy job to make urgently needed copies.

Note

- The procedure for making interrupt copies depends on which kind of operation the machine is currently carrying out.
- You can use Document Server mode in Interrupt Copy mode.
- In Connect Copy mode, you cannot use the Interrupt Copy function on the master unit.
- In Connect Copy mode, you cannot use the Interrupt Copy function on the sub-unit while the master unit is scanning an original.

- In Connect Copy mode, you cannot use the Interrupt Copy function when memory on the sub-unit is full.
- In Connect Copy mode, after finishing the interrupt copy job on the sub-unit, be sure to exit Interrupt mode on the sub-unit. When you exit Interrupt mode, the two machines automatically share the rest of the connect copy job.
- In Connect Copy mode, if the connect copy job is finished before finishing the interrupt copy job on the sub-unit, be sure to exit Interrupt mode on the sub-unit. If you do not exit Interrupt mode, the next connect copy job cannot be started.

To interrupt an original being fed

- 1** Press the **[Interrupt]** key.

The **Interrupt** indicator goes on and scanning stops.

- 2** Remove the originals that were being copied and set the originals you wish to copy.

- 3** Press the **[Start]** key.

The machine starts making your copies.

- 4** When your copy job is finished, remove your originals and copies.

- 5** Press the **[Interrupt]** key again.

The **Interrupt** indicator goes off.

- 6** When the display prompts you to, replace the originals that were being copied before.

- 7** Press the **[Start]** key.

The previous copy job settings will be restored and the machine will continue copying from where it left off.

To interrupt copying after all originals have been fed

- 1** Press the **[Interrupt]** key.

The **Interrupt** indicator goes on.

 **Note**

- Copying will not stop yet.

- 2** Set your original.

- 3** Press the **[Start]** key.

The machine stops the original job and starts copying your original.

4 When copying is complete, remove your originals and copies.

5 Press the **[Interrupt]** key again.

The **Interrupt** indicator goes off.

The previous copy job settings will be restored and the machine will continue copying from where it left off.

2

User Codes

If the machine is set to use the User Code function, operators must input their user codes before the machine can be operated. The machine keeps count of the number of copies made under each user code.

Note

- When the machine is set for the user codes, the machine will prompt you for your user codes after the operation switch is turned on or Auto Reset comes into effect.
- You can adjust how long the machine waits before switching to the user code input display. See “Auto Reset Timer” in ⇒ P.310 “General Features ¹/₃”.
- To prevent others from making copies using your user code, press the **[Clear Modes/Energy Saver]** and **[Clear/Stop]** keys simultaneously after copying.
- You can turn the User Codes on or off with the master unit User Tools (System Settings). See “Set User Codes” in the System Settings manual.
- You can monitor the total number of copies made by the master unit and sub-unit with the master unit User Codes function.
- If the User Codes are set to on in the sub-unit and a code has been entered before Connect Copy was selected, the master unit cannot monitor the number of copies made.
- If the User Codes are set only in the sub-unit, you can enter Connect Copy mode and make copies without entering a code. In this case the number of copies made will not be monitored.

Reference

For how to set up the user codes, see “Set User Codes” in the System Settings manual.

For how to register, change and delete the user codes, see “User Code Register/Change/Delete” in ⇒ P.331 “Count Manager”.

Auto Start

If you press the **[Start]** key during the warm-up period, the **[Start]** key will blink, and your copies will be made as soon as warm-up finishes.

1 Make any adjustments to copy settings during the warm-up period.

2 Set your originals.

3 Press the **[Start]** key.

Copying automatically starts when the **[Start]** key indicator flashes red and green and the machine is ready for copying.

 **Note**

- In Connect Copy mode, copying starts when the master unit is ready for copying.
- To cancel Auto Start, press the **[Clear/Stop]** key.
- In Connect Copy mode, press the **[Clear/Stop]** key on the master unit to cancel Auto Start.

2

Original Beeper

The beeper sounds and an error message is displayed when you leave your originals on the exposure glass after copying.

 **Note**

- You can adjust when the beeper sounds with the “Auto Response (Human) Sensor” setting:
 - If set to “Yes”, the beeper sounds as soon as you leave the machine after copying.
 - If set to “No”, the beeper sounds 2 seconds after copying. See “Auto Response (Human) Sensor” in the System Settings manual.
- To cancel this function, see “Original Beeper” in ⇒ P.313 “General Features ^{2/3}”.

Sample Copy

Use this function to check a copy set before making a long copy run.

 **Limitation**

- This function can be used only when the Sort function has been turned on.

 **Note**

- This function is only available on the master unit in Connect Copy mode.

1 Select Sort and any other functions, then enter the number of copy sets to be made.

2 Set the originals.

3 Press the **[Sample Copy]** key.

One copy set is delivered for proof copying.

4 After checking the finish, press the [Resume] key if the sample is acceptable.

The number of copies made is the number you specified minus one for the proof copy.

Note

- If you press the [Cancel] key after checking the finish, return to step 1 to adjust the copy settings as necessary. You can change the settings for Staple, Punch, Duplex, Copy Orientation, Stamp, Margin Adjust, and Cover/Slip Sheet. However, depending on the combinations of functions, some settings might not be changed.

2

Changing the Number of Sets

You can change the number of copy sets during copying.

Limitation

- This function can be used only when the Sort function has been turned on.

1 Press the [Clear/Stop] key when “Copying” is displayed.

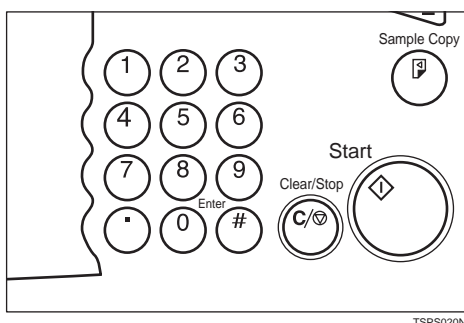

2 Press the [Change No. of sets] key.

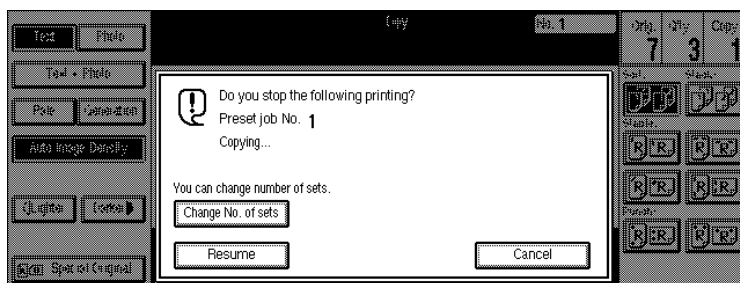

- 3** Enter the number of copy sets with the number keys, then press the **[#]** key.

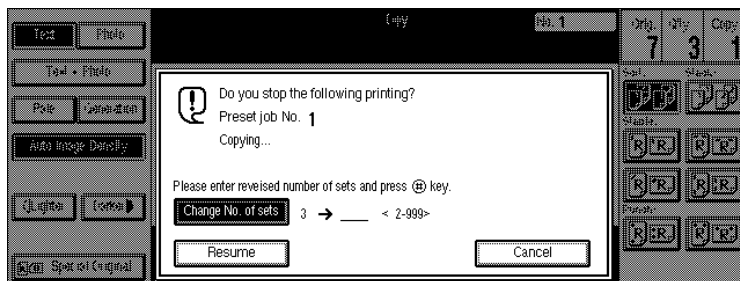

Note

- The number of sets you can enter differs depending on the timing of pressing the **[Clear/Stop]** key.
- To change the entered number, press the **[Clear/Stop]** key.

- 4** Press the **[Resume]** key.

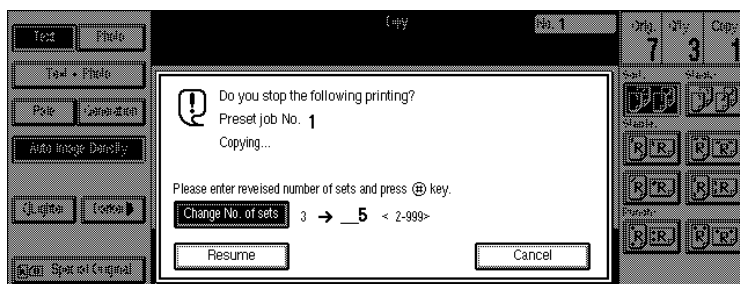

Preset Reduce/Enlarge

You can select a preset ratio for copying.

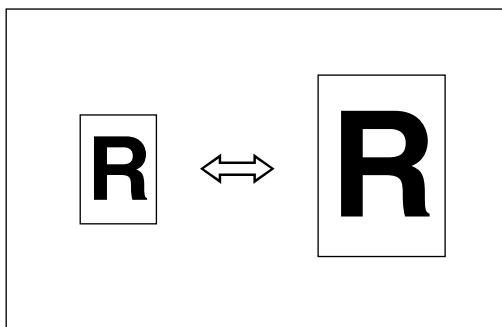

Note

- You can select one of 11 preset ratios (5 enlargement ratios, 6 reduction ratios).
- Use “Shrink&Center” to reduce the image to 93% of its original size with the center as reference. You can register this function in a shortcut key on the initial display.
- You can change the preset ratios to other ratios you frequently use. See “Enlarge” in ⇒ P.315 “Reproduction Ratio $1/2$ ” and “Reduce” in ⇒ P.316 “Reproduction Ratio $2/2$ ”.
- You can set and display three kinds of ratio on the initial display. See “Shortcut R/E” in ⇒ P.315 “Reproduction Ratio $1/2$ ”.
- You can specify which of **[Reduce]**, **[Enlarge]** or **[Input Ratio]** is to be given priority and displayed when the **[Reduce/Enlarge]** key is pressed. See “R/E Priority” in ⇒ P.315 “Reproduction Ratio $1/2$ ”.
- You can select a ratio regardless of the size of an original or copy paper. With some ratios, parts of the image might not be copied or margins will appear on copies.
- Copies can be reduced or enlarged as follows:

◆ Metric version

Ratio (%)	Original → Copy paper size
400 (enlarge area by 16)	--
200 (enlarge area by 4)	A5→A3
141 (enlarge area by 2)	A4→A3, A5→A4
122	F→A3, A4→B4
115	B4→A3
93	--

Ratio (%)	Original → Copy paper size
82	F→A4, B4→A4
75	B4→F4, B4→F
71 (reduce area by $\frac{1}{2}$)	A3→A4, A4→A5
65	A3→F
50 (reduce area by $\frac{1}{4}$)	A3→A5, F→A5

◆ Inch version

Ratio (%)	Original → Copy paper size
400 (enlarge area by 16)	--
200 (enlarge area by 4)	$5\frac{1}{2}'' \times 8\frac{1}{2}'' \rightarrow 11'' \times 17''$
155 (enlarge area by 2)	$5\frac{1}{2}'' \times 8\frac{1}{2}'' \rightarrow 8\frac{1}{2}'' \times 14''$
129	$8\frac{1}{2}'' \times 11'' \rightarrow 11'' \times 17''$
121	$8\frac{1}{2}'' \times 14'' \rightarrow 11'' \times 17''$
93	--
85	F→ $8\frac{1}{2}'' \times 11''$
78	$8\frac{1}{2}'' \times 14'' \rightarrow 8\frac{1}{2}'' \times 11''$
73	$11'' \times 15'' \rightarrow 8\frac{1}{2}'' \times 11''$
65	$11'' \times 17'' \rightarrow 8\frac{1}{2}'' \times 11''$
50 (reduce area by $\frac{1}{4}$)	$11'' \times 17'' \rightarrow 5\frac{1}{2}'' \times 8\frac{1}{2}''$

1 Press the [Reduce/Enlarge] key.

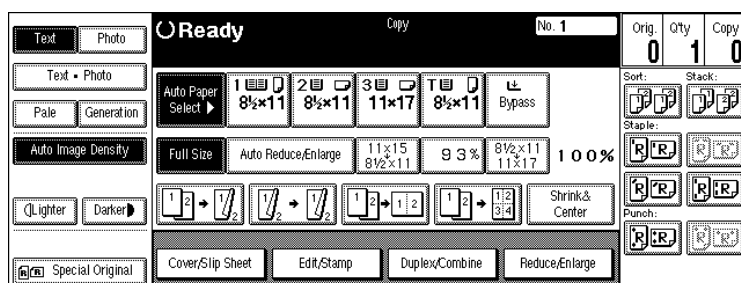

Note

- To select a preset ratio on the initial display, directly press the shortcut reduce/enlarge key and go to step 5.

2 Press the [Enlarge] or [Reduce] key.

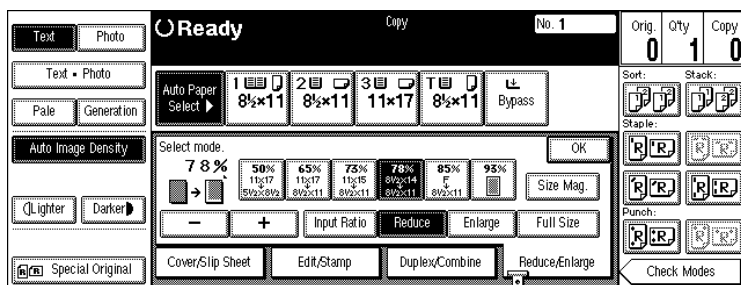

3 Select a ratio.

4 Press the [OK] key.

5 Set your originals, then press the [Start] key.

Shrink&Center mode

Use "Shrink&Center" to reduce the image by 93% of its original size with the center position as reference. You can register this function in a shortcut key on the initial display. By combining it with the Reduce/Enlarge function, you can also provide the Reduce/Enlarge copy with a margin.

Note

- You can register "Shrink&Center" in a shortcut key. See "Shortcut Keys" in ⇒ P.314 "General Features ³/₃".
- You can change the Reduce/Enlarge ratio for "Shrink&Center". See "Shrink&Center Ratio" in ⇒ P.316 "Reproduction Ratio ²/₂".

1 Press the [Shrink&Center] key displayed on the initial display.

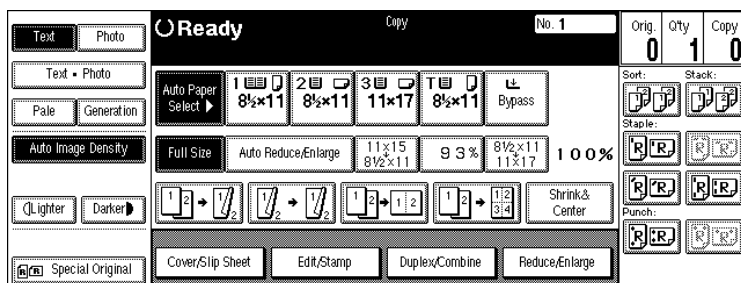

2 If you do not wish to combine it with the Reduce/Enlarge function, set your originals, then press the [Start] key.

Zoom

You can change the reproduction ratio in 1% steps.

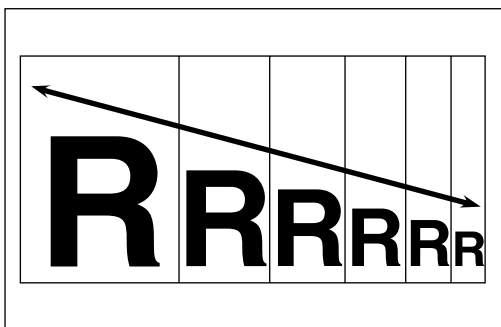

Note

- The following ratios can be selected:
 - Metric version: 25 – 400%
 - Inch version: 25 – 400%
- You can select a ratio regardless of the size of an original or copy paper. With some ratios, parts of the image might not be copied or margins will appear on copies.
- You can select a preset ratio which is near the desired ratio, then adjust the ratio with the **[+]** or **[-]** key.

1 Press the **[Reduce/Enlarge]** key.

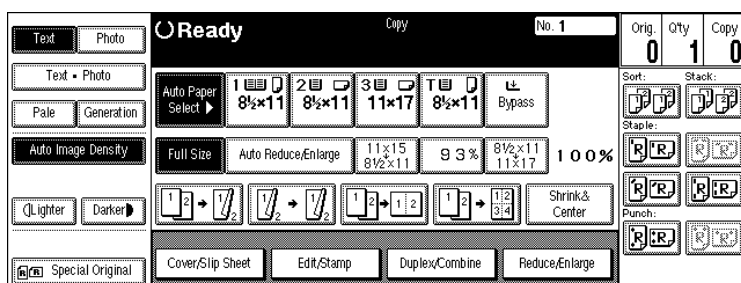

2 Enter the ratio.

To select the ratio with the **[+]** and **[-]** keys

- 1 Select a preset ratio which is close to the desired ratio by using **[Reduce]** or **[Enlarge]**.

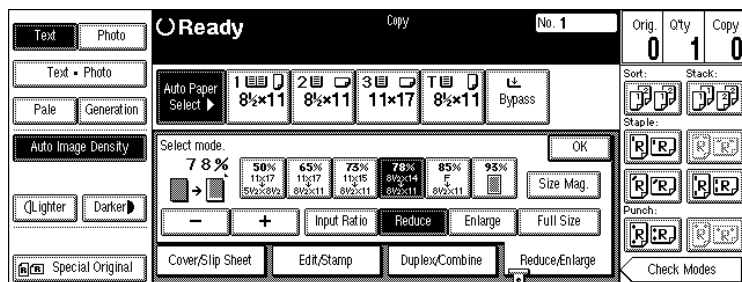

- 2 Adjust the ratios with the **[+]** or **[-]** key.

Note

- To change the ratio in 1% steps, just press the **[+]** or **[-]** key. To change the ratio in 10% steps, press and hold down the **[+]** or **[-]** key.

To enter the ratio with the number keys

- 1 Press the **[Input Ratio]** key.

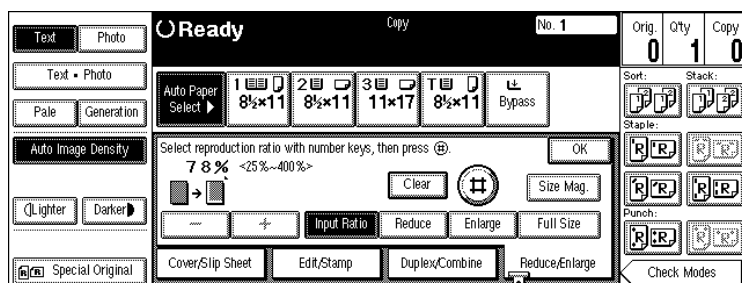

- 2 Enter the desired ratio with the number keys.

Note

- To change the ratio entered, press the **[Clear]** or **[Clear/Stop]** key and enter the new ratio.

- 3 Press the **[#]** key.

- 4 Press the **[OK]** key.

- 3 Set your originals, then press the **[Start]** key.

Size Magnification

This function calculates an enlargement or reduction ratio based upon the lengths of the original and copy.

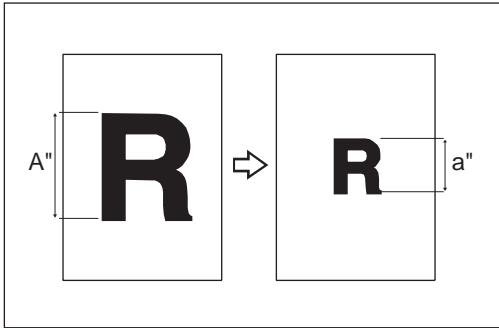

Preparation

Measure and specify the lengths of the original and copy by comparing “A” with “a.”

Limitation

- If the calculated ratio is over the maximum or under the minimum ratio, it is corrected within the range of the ratio automatically. However, with some ratios, parts of the image might not be copied or blank margins will appear on copies.

Note

- A ratio is selected in the range of 25 to 400%.

1 Press the [Reduce/Enlarge] key.

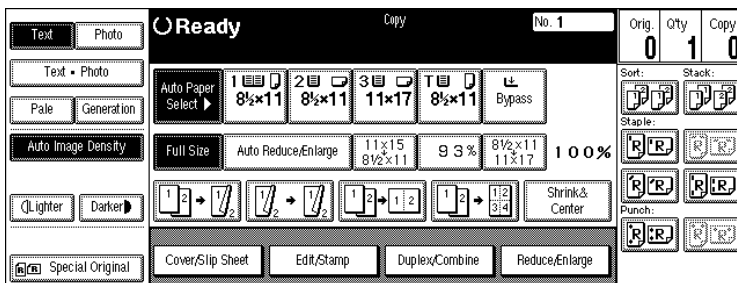

2 Press the [Size Mag.] key.

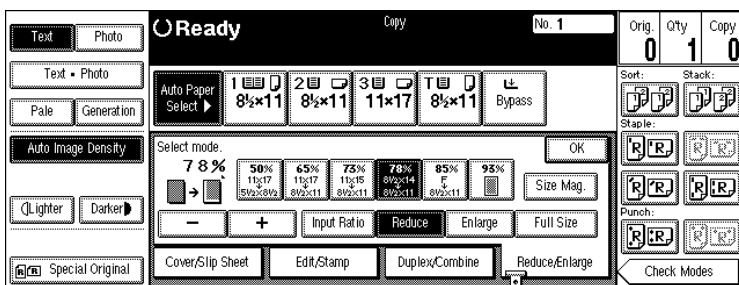

3 Make sure that the [Size Mag.] key is highlighted.

4 Enter the length of the original with the number keys and press the [#] key.

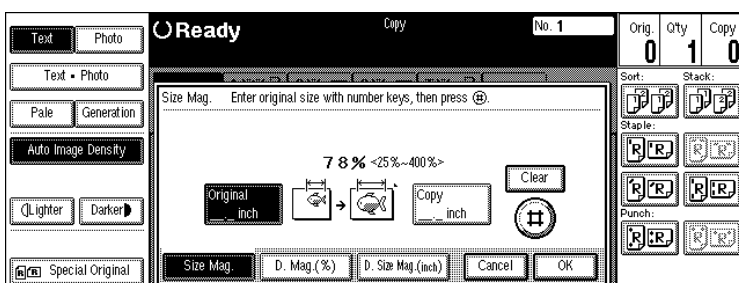

Note

You can enter sizes within the following ranges:

Metric version	1 – 999mm (in 1mm steps)
Inch version	0.1" – 99.9" (in 0.1" steps)

To change the length entered, press the [Clear] or [Clear/Stop] key and enter the new length.

5 Enter the length of the copy with the number keys and press the [#] key.

Note

To change the length entered, press the [Clear] or [Clear/Stop] key and enter the new length.

To change the length after pressing the [#] key, select [Original] or [Copy] and enter the desired length.

6 Press the [OK] key.

7 Press the [OK] key.

8 Set your original, then press the [Start] key.

Directional Magnification (%)

Copies can be reduced or enlarged at different reproduction ratios horizontally and vertically.

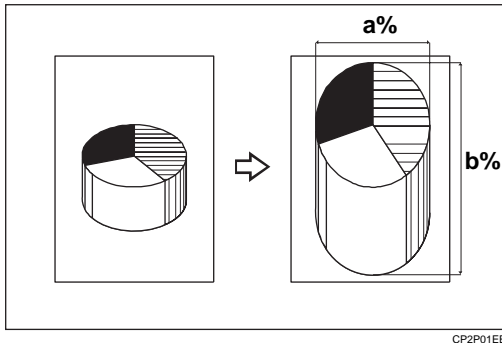

CP2P01EE

Note

- The following ratios can be selected:
 - Metric version: 25 – 400%
 - Inch version: 25 – 400%
- You can select a ratio regardless of the size of an original or copy paper. With some ratios, parts of the image might not be copied or blank margins will appear on copies.
- You can also select a preset ratio which is close to the desired ratio by using Reduce or Enlarge, then adjust the ratio with the **[+]** or **[-]** key.

1 Press the [Reduce/Enlarge] key.

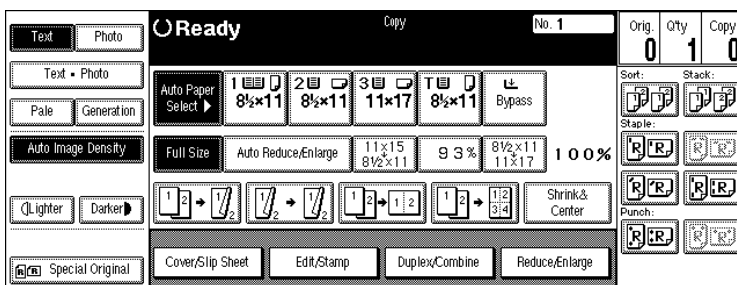

2 Press the [Size Mag.] key.

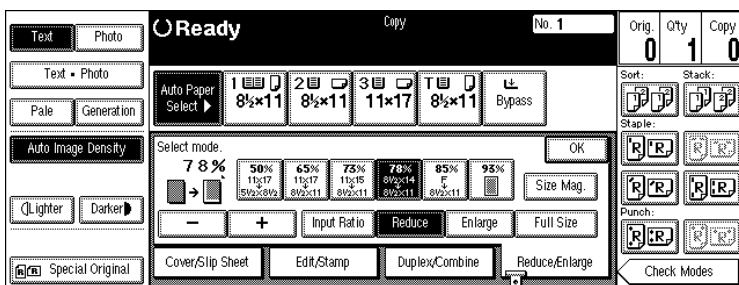

3 Press the [D. Mag.(%)] key.

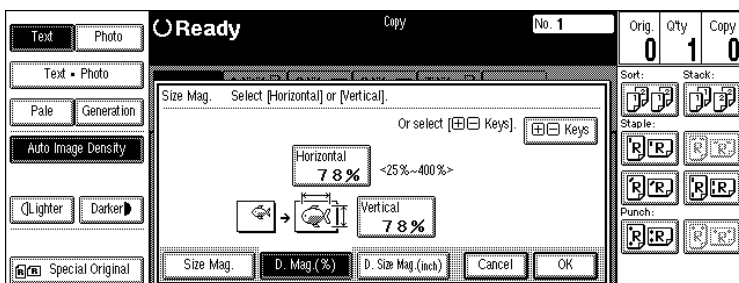

To specify a ratio with the [+] and [-] keys

- 1** Press the [+ - Keys] key.
- 2** Press the [Horizontal] key.

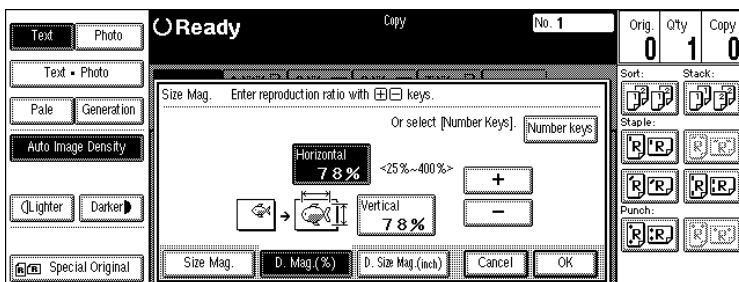

- 3** Adjust the ratio using the [+] or [-] key.

Note

- Pressing the [+] or [-] key changes the ratio in 1% steps. Pressing and holding down the [+] or [-] key changes it in 10% steps.
- If you have incorrectly entered the ratio, readjust the ratio with the [+] or [-] key.

- 4** Press the [Vertical] key.
- 5** Adjust the ratio with the [+] or [-] key.
- 6** Press the [OK] key.

To enter the ratio with the number keys

- 1 Press the [Horizontal] key.

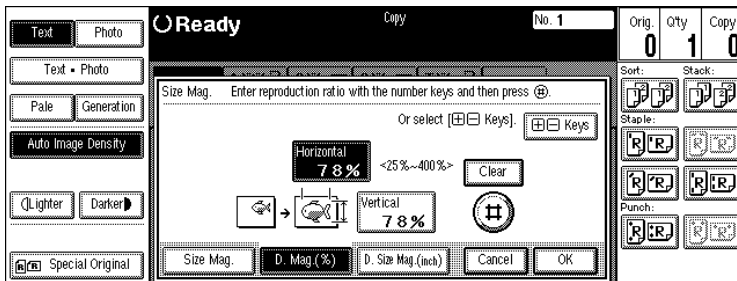

- 2 Enter the desired ratio with the number keys, followed by the [#] key.

Note

- To change the ratio entered, press the [Clear] or [Clear/Stop] key and enter the new ratio.

- 3 Press the [Vertical] key.
 - 4 Enter the desired ratio with the number keys, followed by the [#] key.
 - 5 Press the [OK] key.
- 4 Press the [OK] key.
 - 5 Set your originals, then press the [Start] key.

Directional Size Magnification (inch)

The suitable reproduction ratios will be automatically selected when you enter the horizontal and vertical lengths of the original and copy image you require.

2

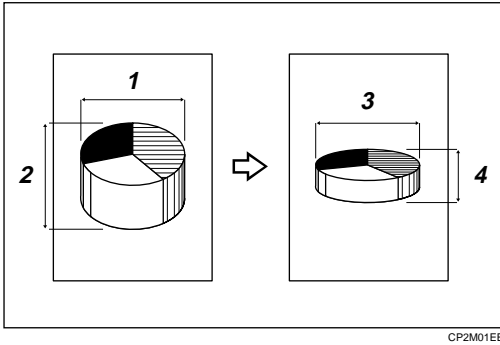

CP2M01EE

- 1: Horizontal original size
- 2: Vertical original size
- 3: Horizontal copy size
- 4: Vertical copy size

 **Preparation**

Specify the vertical and horizontal sizes of the original and those of the copy, as shown in the illustration.

 **Limitation**

- If the calculated ratio is over the maximum or under the minimum ratio, it is corrected within the range of the ratio automatically. However, with some ratios, parts of the image might not be copied or blank margins will appear on copies.

 **Note**

- You can enter sizes within the following ranges:

Metric version	1 – 999mm (in 1mm steps)
Inch version	0.1" – 99.9" (in 0.1" steps)

- The following ratios can be selected:
 - Metric version: 25 – 400%
 - Inch version: 25 – 400%

1 Press the [Reduce/Enlarge] key.

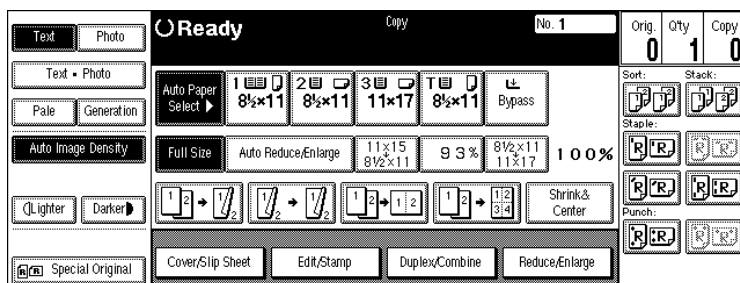

2 Press the [Size Mag.] key.

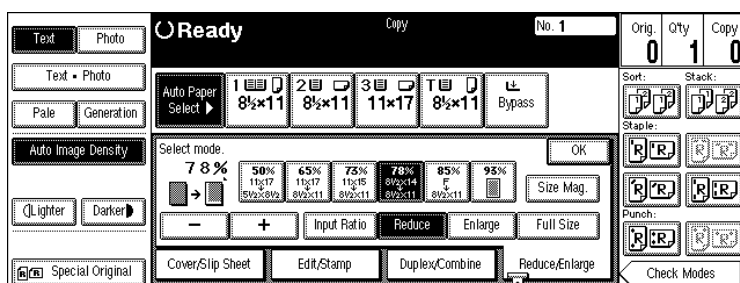

3 Press the [D. Size Mag.(inch)] key.

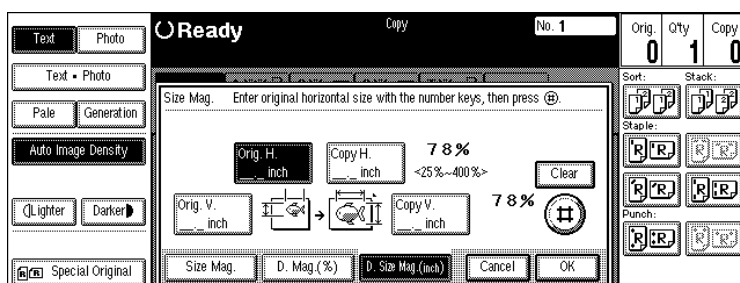

4 Enter the horizontal size of the original with the number keys, then press the [#] key.

Note

- To change the value entered, press the [Clear] or [Clear/Stop] key and enter the new value.

5 Enter the horizontal size of the copy with the number keys, then press the [#] key.

6 Enter the vertical size of the original with the number keys, then press the [#] key.

7 Enter the vertical size of the copy with the number keys, then press the [#] key.

 **Note**

- To change the length, press the place you wish to change and enter the new value.

8 Press the [OK] key.

9 Press the [OK] key.

2 **10** Set your originals, then press the **[Start]** key.

Duplex/Combine

You can make copies in a variety of formats by combining the following modes:

- 1 Sided/2 Sided originals
- 1 Sided/2 Sided copies
- Duplex
- Combine
- Book
- Series

2

1 Check your originals and select [1 Sided] or [2 Sided] for the originals.

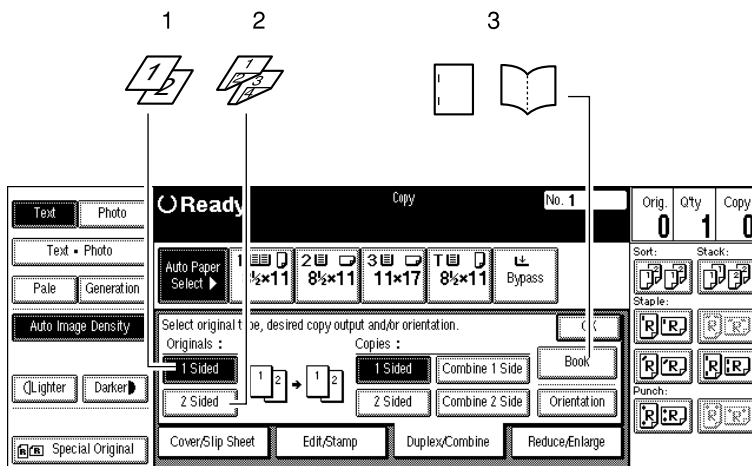

ZBQS100N

- 1: 1-sided
- 2: 2-sided
- 3: Book

2 Select [1 Sided] or [2 Sided] for copying.

2

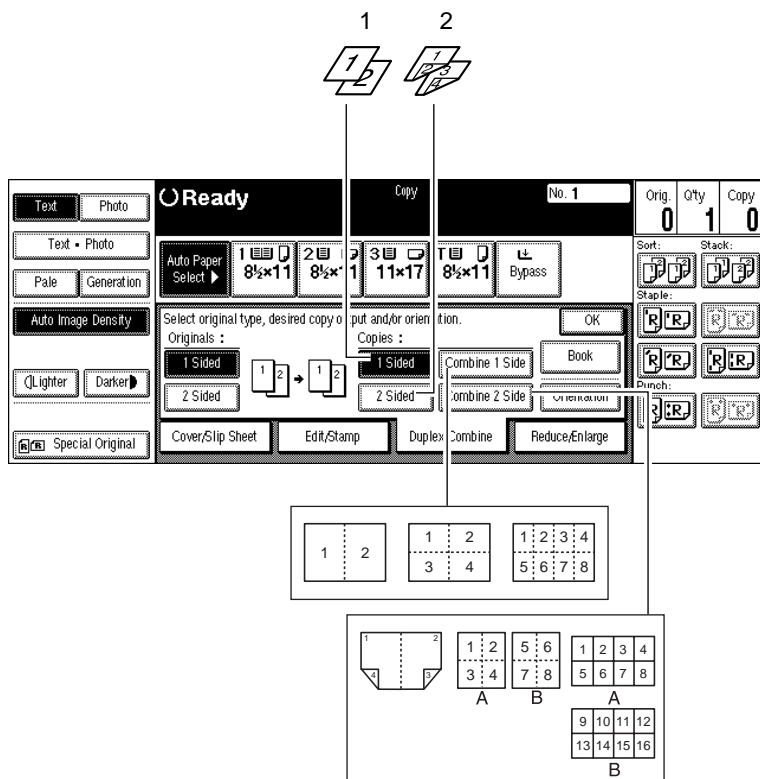

1: 1-sided

2: 2-sided



A: Front







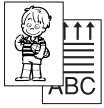
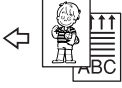

B: Back

3 Press the [OK] key.

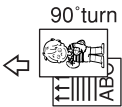
ZBQS110E

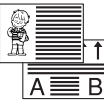
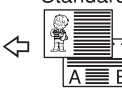
Original Direction and Completed Copies

The resulting copy image will differ according to the direction in which you set your original (lengthwise  or widthwise .

Original	How to Set Your Original	Copy
Vertical 	Standard 	Top to Top 
	90° turn 	Top to Bottom 
Horizontal 	Standard 	Top to Top 
	90° turn 	Top to Bottom 

GCRY0U1E

 **Note**

 The illustrations show the directions of copied images on the front and back, not the directions of delivery.

Originals and Copy Direction

You can select the orientation ([**Top to Top**], [**Top to Bottom**]). See ⇒ P.110 “*Specifying Orientation of Bound Originals*”.

- Top to Top

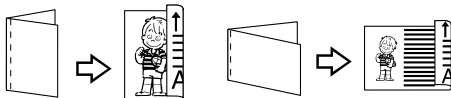

Duplex1

- Top to Bottom

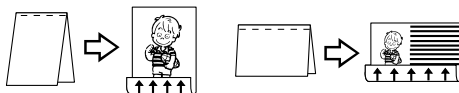

Duplex2

Specifying Orientation of Bound Originals

You can specify the orientation of bound originals (how you turn the pages). The default setting is **[Top to Top]**.

 **Note**

- ❑ You can change the orientation default with the User Tools. See “Copy Orientation in Duplex Mode” and “Original Orientation in Duplex Mode” in ⇒ P.313 “General Features ²/₃”.

1 Press the **[Duplex/Combine]** key.

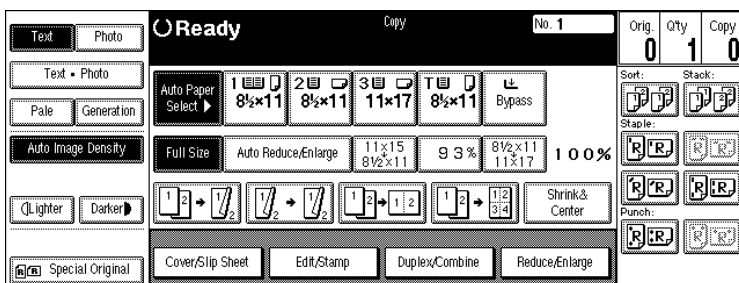

2 Press the **[Orientation]** key.

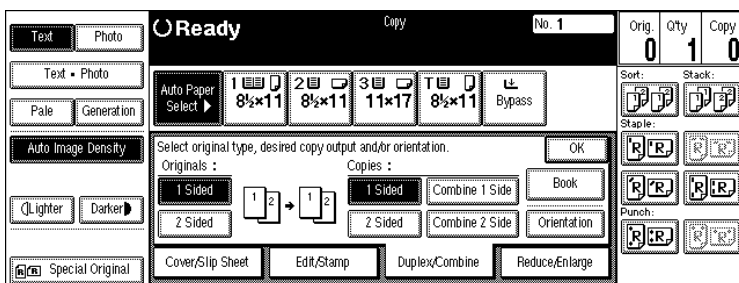

3 Select an original orientation and a copy orientation.

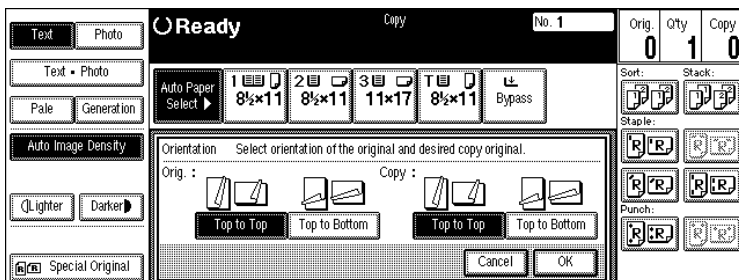

4 Press the **[OK]** key.

Duplex

This function can be used in two ways:

❖ 1 Sided → 2 Sided

This mode makes two-sided copies from one-sided originals.

❖ 2 Sided → 2 Sided

This mode makes two-sided copies from two-sided originals.

💡 Limitation

You cannot use the following copy paper in this function:

- Paper smaller than A5 , 5¹/₂" × 8¹/₂" (possible on A5 , 5¹/₂" × 8¹/₂")
- Paper thicker than 105g/m², 28 lb. Bond
- Paper thinner than 64g/m², 17 lb. Bond
- Translucent paper
- Adhesive labels
- OHP transparencies
- Postcards

You cannot use the bypass tray with this function.

1 Sided → 2 Sided

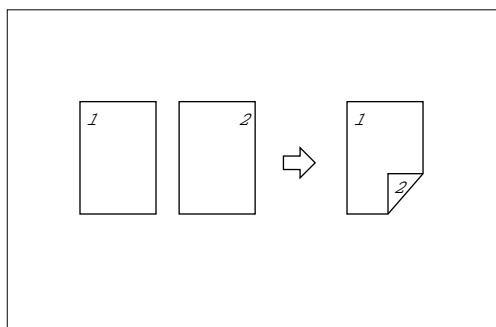

📌 Note

- If you set an odd number of 1-sided originals in the document feeder, the reverse side of the last page is left blank.
- If you set originals in the document feeder and select Sort mode, all the originals will be scanned before being copied. Therefore, the copy speed is faster than that when Sort mode is not selected. See "Auto Sort Mode" in ⇒ P.329 "Input/Output".

- ❑ When original images are copied, the images are shifted by a width of the binding margin. You can adjust the binding margin or binding position. You can also change their default values. See “Front Margin: Left/Right”, “Back Margin: Left/Right”, “Front Margin: Top/Bottom” and “Back Margin: Top/Bottom” in ⇒ P.317 “Page Format 1/2”.
- ❑ A binding margin can be automatically made on the back side. See “1 → 2 Duplex Auto Margin Adjust” in ⇒ P.317 “Page Format 1/2”.

2

1 Press the [Duplex/Combine] key.

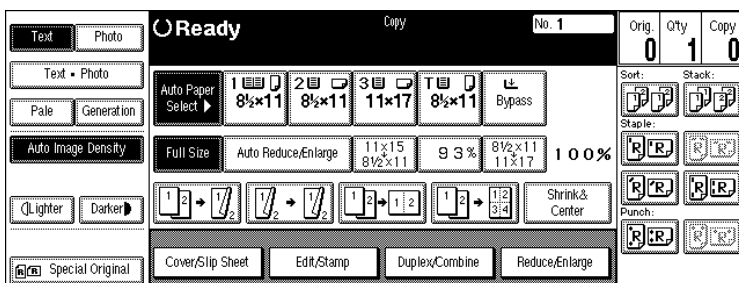

2 Press the [1 Sided] key for original, then press the [2 Sided] key for copy.

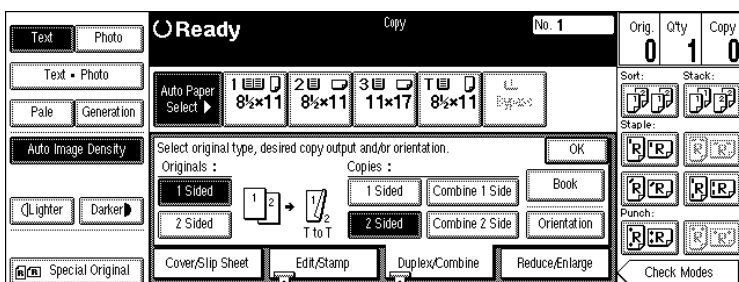

Note

- ❑ To change the copy orientation to “Top to Bottom”, press the [Orientation] key and select [Top to Bottom]. See ⇒ P.110 “Specifying Orientation of Bound Originals”.

3 Press the [OK] key.

4 Set your originals, then press the [Start] key.

When setting an original on the exposure glass or in the document feeder using Batch (SADF) mode

Reference

⇒ P.36 “Batch (SADF) mode”.

1 Set the original, then press the [Start] key.

Note

- ❑ Start with the first page to be copied.

- ② Set the next original. When it is placed on the exposure glass, press the **[Start]** key.
- ③ Press the **[#]** key after the last original has been scanned.

2 Sided → 2 Sided

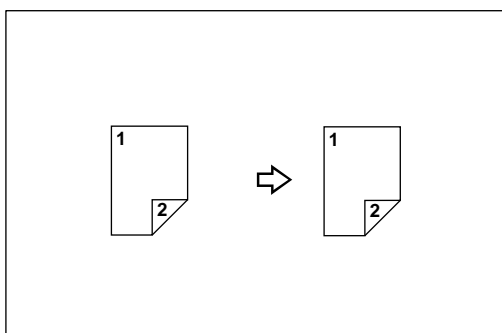

- ① Press the **[Duplex/Combine]** key.

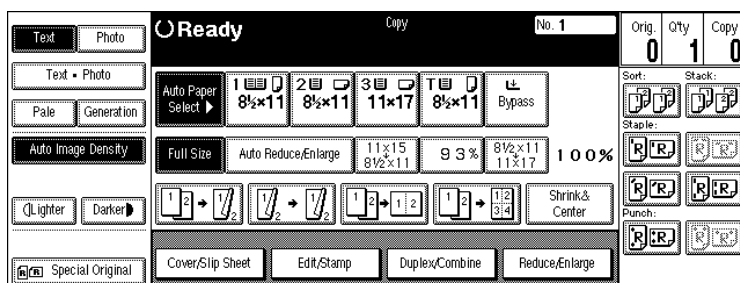

- ② Press the **[2 Sided]** key for original, then press the **[2 Sided]** key for copy.

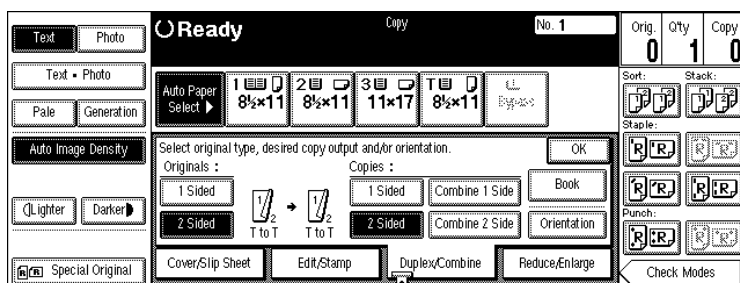

Note

- ❑ To change the copy orientation to “Top to Bottom”, press the **[Orientation]** key and select **[Top to Bottom]**. See ⇒ P.110 “Specifying Orientation of Bound Originals”.

- ③ Press the **[OK]** key.
- ④ Set your originals, then press the **[Start]** key.

When setting an original on the exposure glass or in the document feeder using Batch (SADF) mode

 **Reference**

⇒ P.36 "*Batch (SADF) mode*".

1 Set the original, then press the **【Start】** key.

 **Note**

Start with the first page to be copied.

2 Set the next original. When it is placed on the exposure glass, press the **【Start】** key.

3 Press the **【#】** key after the last original has been scanned.

Combine

You can combine two or more originals into one copy. 1 Sided Combine mode is for 1-sided copies, and 2 Sided Combine mode for 2-sided copies.

This function can be used in twelve ways:

- ❖ **1 Sided 2 Pages → Combine 1 Side**
Copies two 1-sided originals to one side of a sheet.
- ❖ **1 Sided 4 Pages → Combine 1 Side**
Copies four 1-sided originals together to one side of a sheet.
- ❖ **1 Sided 8 Pages → Combine 1 Side**
Copies eight 1-sided originals together to one side of a sheet.
- ❖ **1 Sided 4 Pages → Combine 2 Side**
Copies four 1-sided originals to the two-page spread on both sides of a sheet.
- ❖ **1 Sided 8 Pages → Combine 2 Side**
Copies eight 1-sided originals together to both sides of a sheet.
- ❖ **1 Sided 16 Pages → Combine 2 Side**
Copies 16 1-sided originals together to both sides of a sheet.
- ❖ **2 Sided 2 Pages → Combine 1 Side**
Copies one 2-sided original to one side of a sheet.
- ❖ **2 Sided 4 Pages → Combine 1 Side**
Copies two 2-sided originals to one side of a sheet.
- ❖ **2 Sided 8 Pages → Combine 1 Side**
Copies four 2-sided originals to one side of a sheet.
- ❖ **2 Sided 4 Pages → Combine 2 Side**
Copies two 2-sided originals together to both sides of a sheet.
- ❖ **2 Sided 8 Pages → Combine 2 Side**
Copies four 2-sided originals together to both sides of a sheet.
- ❖ **2 Sided 16 Pages → Combine 2 Side**
Copies eight 2-sided originals together to both sides of a sheet.

📌 Limitation

- You cannot use the bypass tray with this function.
- If the calculated ratio is under the minimum ratio, it is corrected within the range of the ratio automatically. However, with some ratios, parts of the image might not be copied.

Note

- ❑ In this mode, the machine selects the reproduction ratio automatically. This reproduction ratio depends on the copy paper sizes and the number of originals.
- ❑ The machine uses ratios in the following range:
 - Metric version: 25 – 400%
 - Inch version: 25 – 400%
- ❑ A separation line between originals can be printed with the User Tools. See “Combine Separation Line” in ⇒ P.320 “Page Format $2/2$ ”.
- ❑ Even if the direction of originals is different from that of the copy paper, the machine will automatically rotate the image by 90° to make copies properly.
- ❑ When making copies in Combine mode, the border of each original can be automatically erased by 3mm, 0.1”. See “Combine Orig. Shadow Erase” in ⇒ P.317 “Page Format $1/2$ ”.
- ❑ If the number of originals placed is less than the number specified for combining, the last page is copied blank as shown in the illustration.

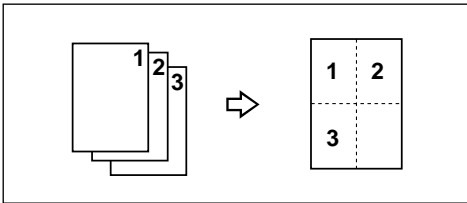

- ❑ You can change the copy order in Combination mode. See “Copy Order In Combine Mode” in ⇒ P.320 “Page Format $2/2$ ”.
- ❑ Direction of the originals and arrangement of combined images

❖ **Portrait (📄) originals**

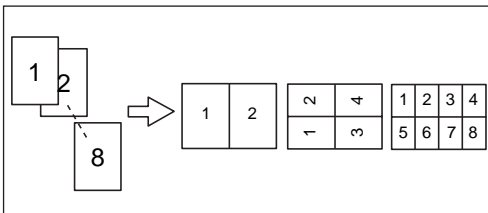

GCSHUY1E

❖ **Landscape (📄) originals**

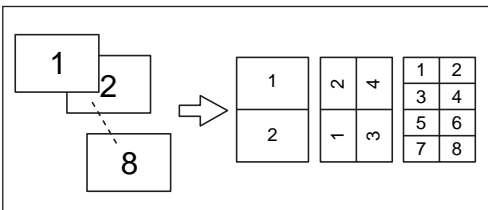

GCSHUY2E

1 Sided 2 Pages → Combine 1 Side

Copies two 1-sided originals to one side of a sheet.

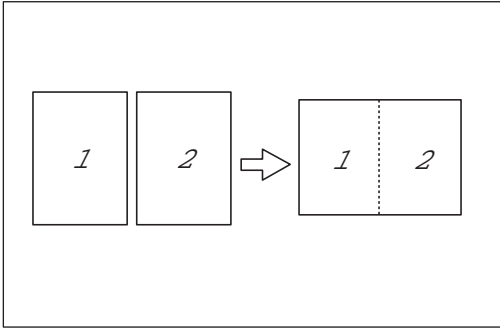

GC SHVY TJ

❖ Setting originals (Originals set in the document feeder)

- Originals read from left to right

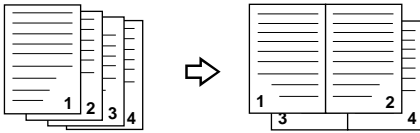

Combine5

- Originals read from top to bottom

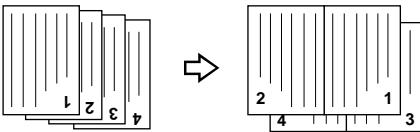

Combine6

1 Press the [Duplex/Combine] key.

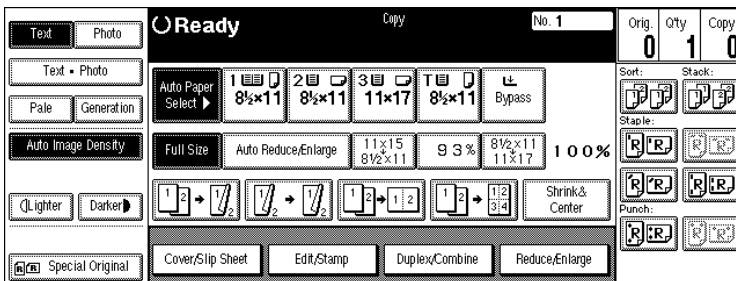

- Press the [1 Sided] key for the original, then press the [Combine 1 Side] key for the copy.

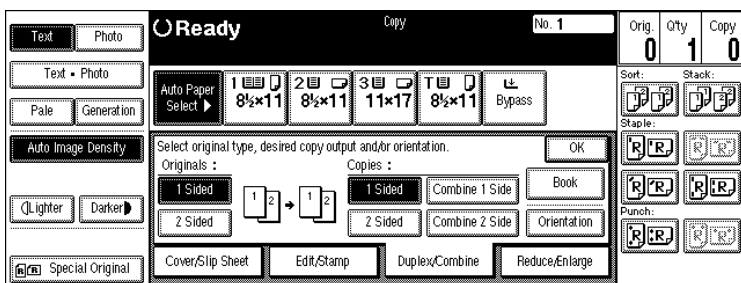

- Press the [2 Originals] key, then press the [OK] key.

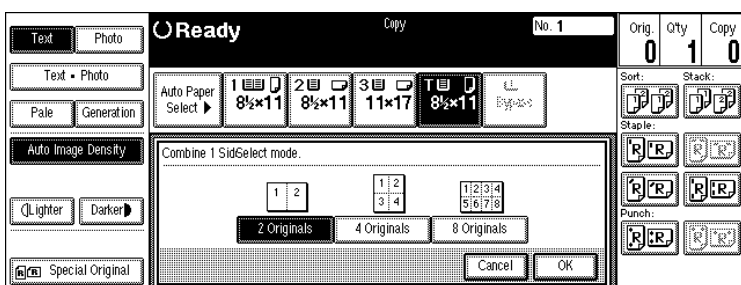

- Select the paper.

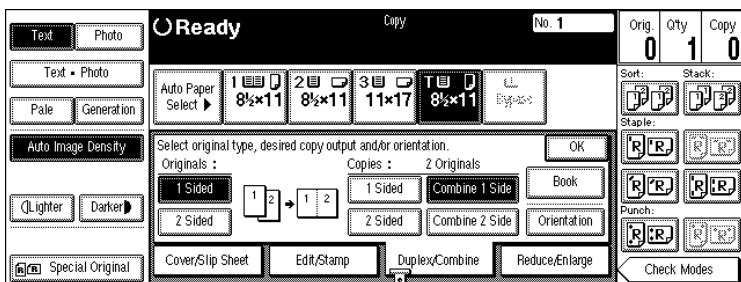

- Set your originals, then press the [Start] key.

1 Sided 4 Pages → Combine 1 Side

Copies four 1-sided originals together to one side of a sheet.

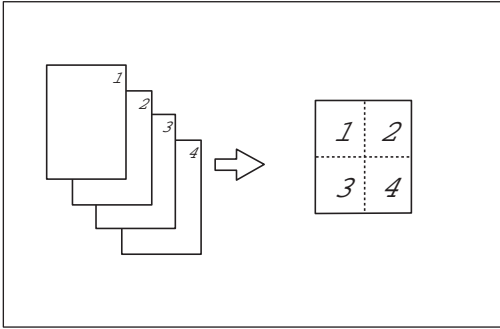

GC SHVY 6J

1 Press the [Duplex/Combine] key.

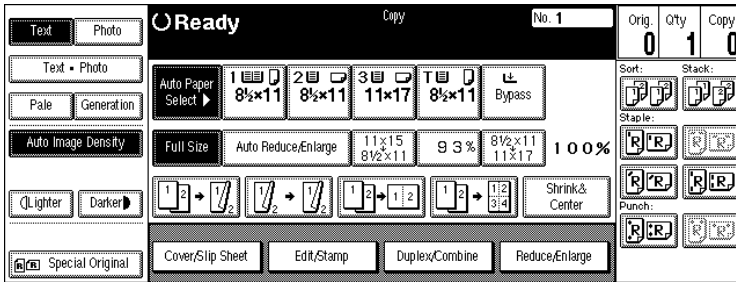

2 Press the [1 Sided] key for the original, then press the [Combine 1 Side] key for the copy.

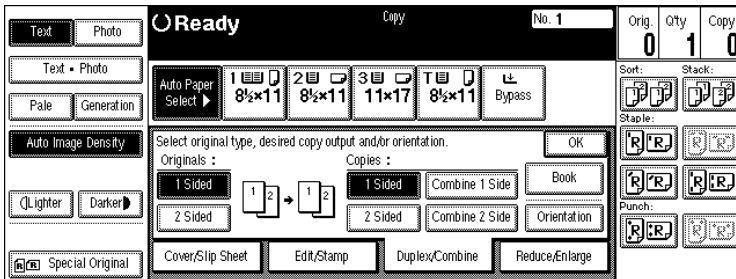

3 Press the [4 Originals] key, then press the [OK] key.

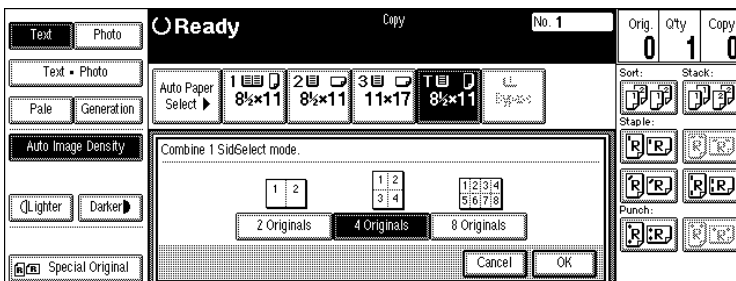

4 Select the paper.

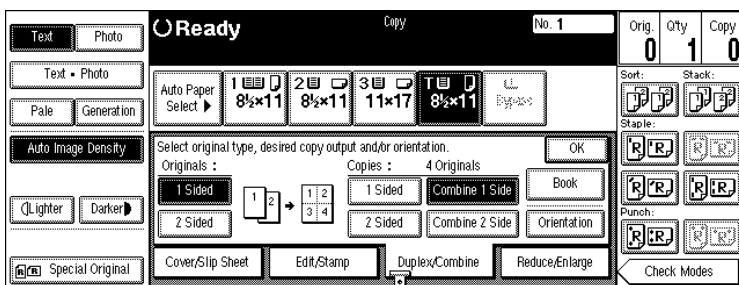

5 Set your originals, then press the **[Start]** key.

1 Sided 8 Pages → Combine 1 Side

Copies eight 1-sided originals together to one side of a sheet.

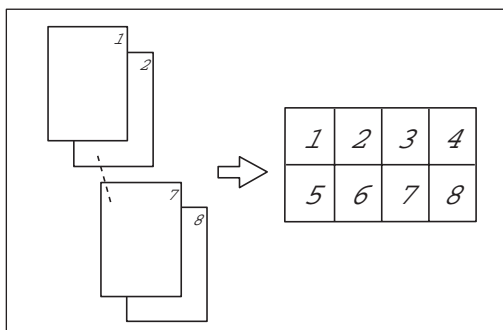

GC SHVY SJ

1 Press the **[Duplex/Combine]** key.

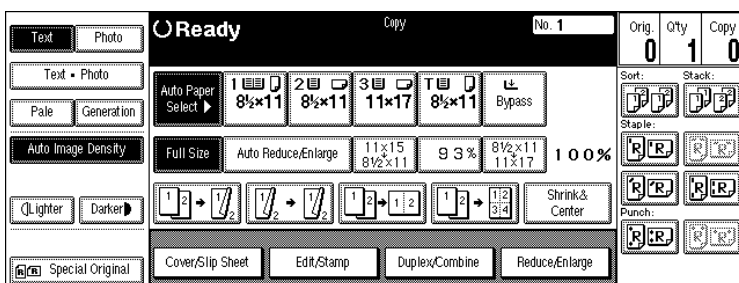

- 2** Press the [1 Sided] key for the original, then press the [Combine 1 Side] key for the copy.

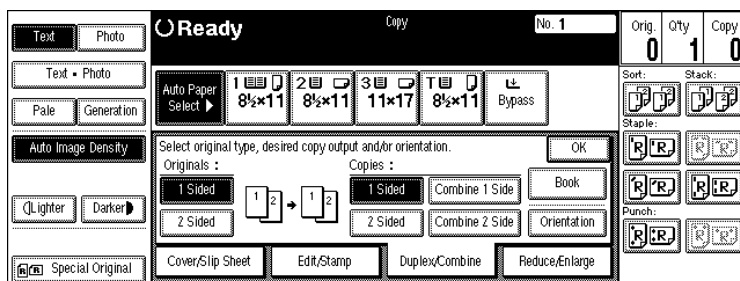

- 3** Press the [8 Originals] key, then press the [OK] key.

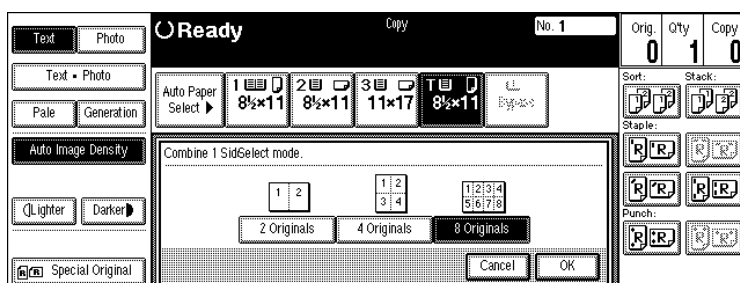

- 4** Select the paper.

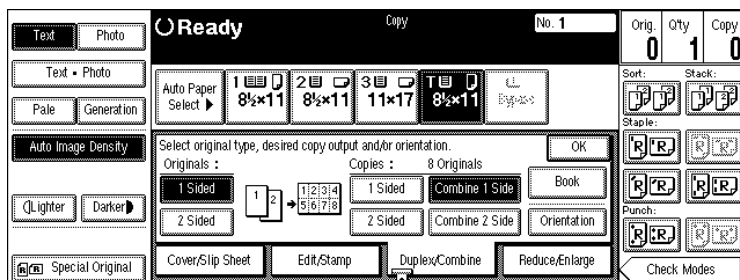

- 5** Set your originals, then press the [Start] key.

2

1 Sided 4 Pages → Combine 2 Side

Copies four 1-sided originals to the two-page spread on both sides of a sheet.

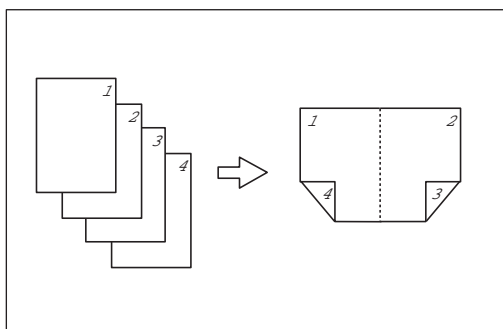

GC SHWY 01

1 Press the [Duplex/Combine] key.

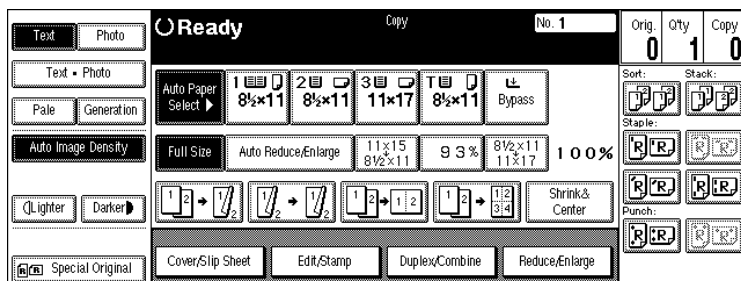

2 Press the [1 Sided] key for the original, then press the [Combine 2 Side] key for the copy.

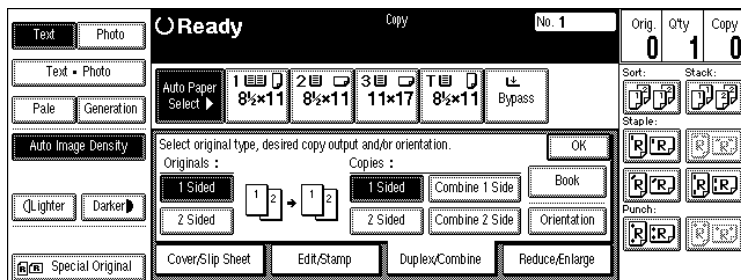

3 Press the [4 Originals] key, then press the [OK] key.

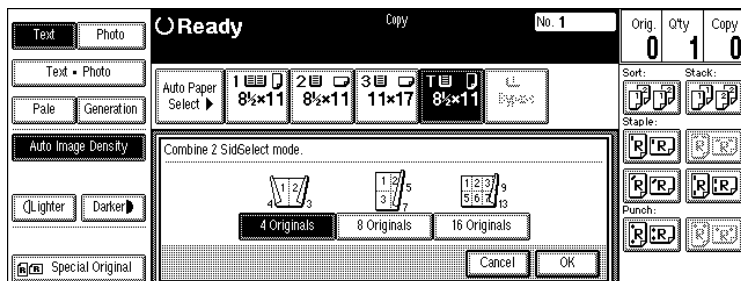

4 Check the orientation.

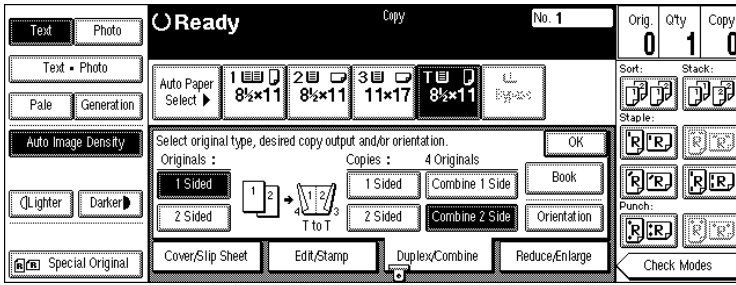

Note

- To change the copy orientation to “Top to Bottom”, press the **[Orientation]** key and select **[Top to Bottom]**. See ⇒ P.110 “Specifying Orientation of Bound Originals”.

5 Press the **[OK]** key.

6 Select the paper.

7 Set your originals, then press the **[Start]** key.

1 Sided 8 Pages → Combine 2 Side

Copies eight 1-sided originals together to both sides of a sheet.

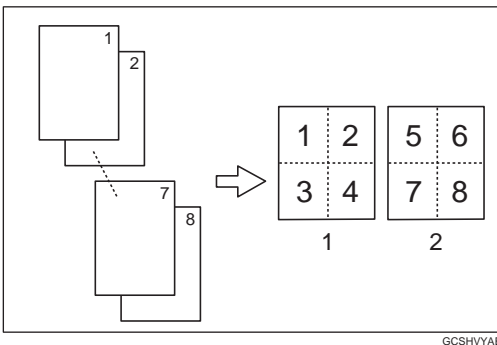

GCSHVYAE

1. Front

2. Back

1 Press the [Duplex/Combine] key.

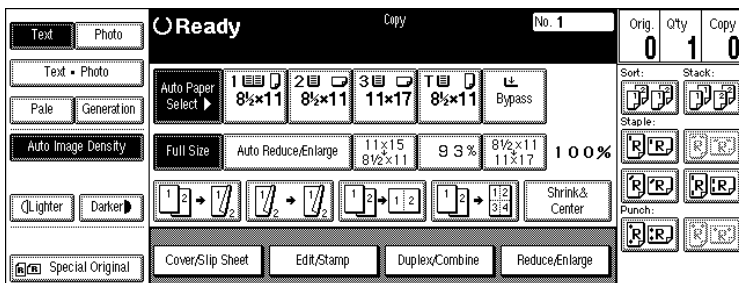

2

2 Press the [1 Sided] key for the original, then press the [Combine 2 Side] key for the copy.

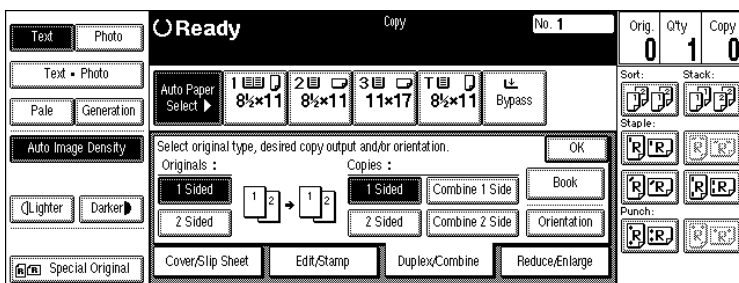

3 Press the [8 Originals] key, then press the [OK] key.

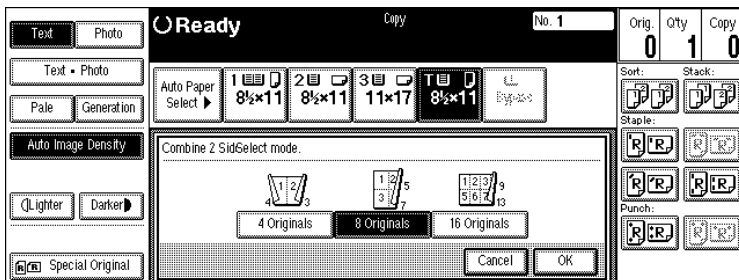

4 Check the orientation.

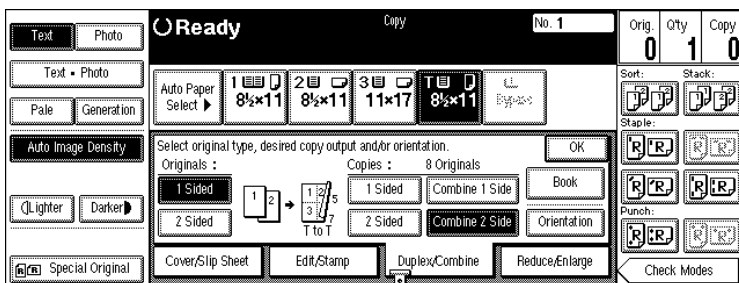

Note

- To change the copy orientation to “Top to Bottom”, press the **[Orientation]** key and select **[Top to Bottom]**. See ⇒ P.110 “Specifying Orientation of Bound Originals”.

5 Press the **[OK]** key.

6 Select the paper.

7 Set your originals, then press the **[Start]** key.

2

1 Sided 16 Pages → Combine 2 Side

Copies sixteen 1-sided originals together to both sides of a sheet.

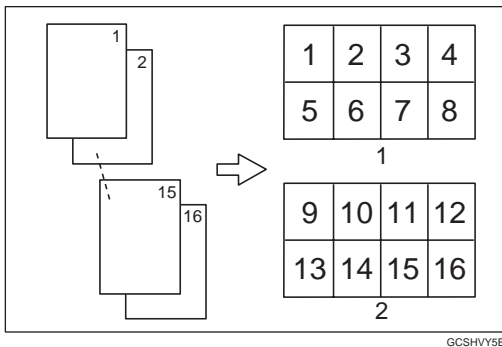

GCSHVY5E

1. Front

2. Back

1 Press the **[Duplex/Combine]** key.

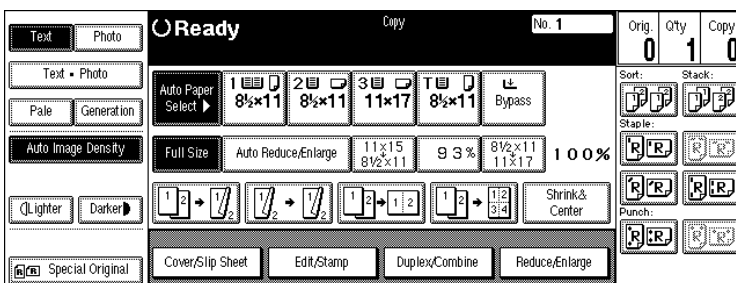

- Press the [1 Sided] key for the original, then press the [Combine 2 Side] key for the copy.

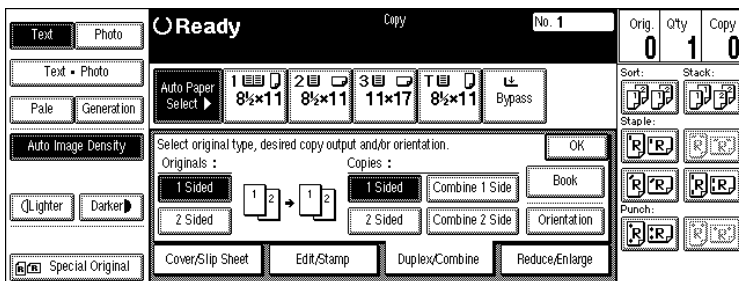

- Press the [16 Originals] key, then press the [OK] key.

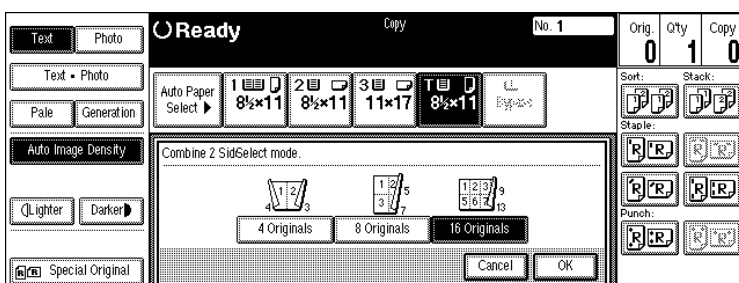

- Check the orientation.

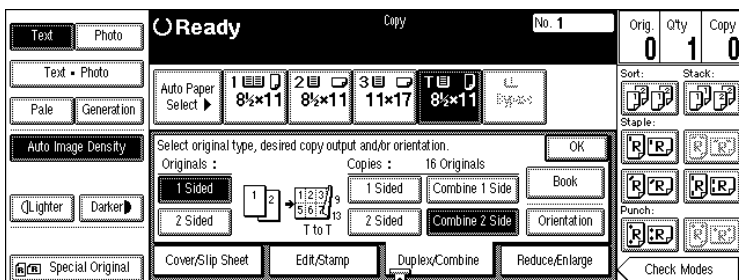

Note

- To change the copy orientation to “Top to Bottom”, press the [Orientation] key and select [Top to Bottom]. See ⇒ P.110 “Specifying Orientation of Bound Originals”.

- Press the [OK] key.
- Select the paper.
- Set your originals, then press the [Start] key.

2 Sided 2 Pages → Combine 1 Side

Copies one 2-sided original to one side of a sheet.

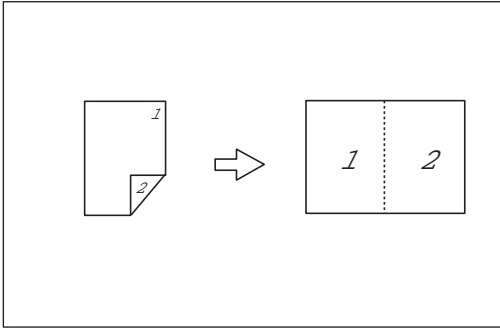

GC SHWY 01

1 Press the [Duplex/Combine] key.

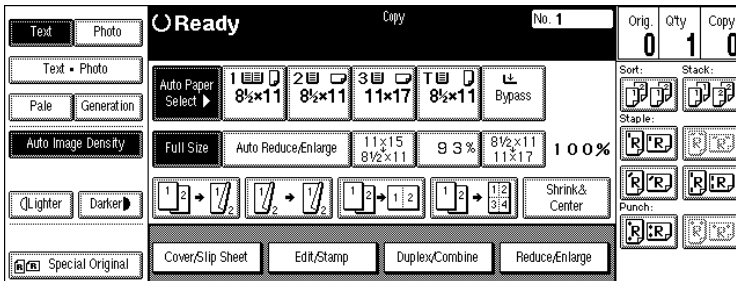

2 Press the [2 Sided] key for the original, then press the [Combine 1 Side] key for the copy.

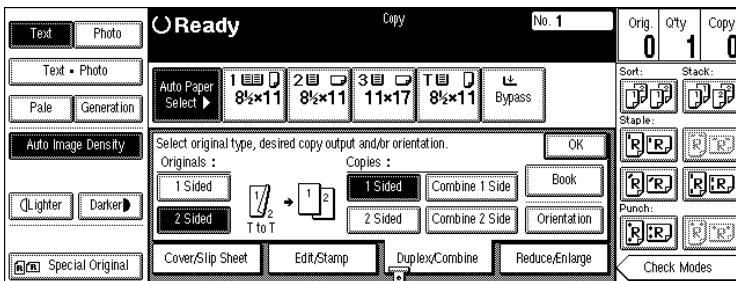

3 Press the [2 Pages] key, then press the [OK] key.

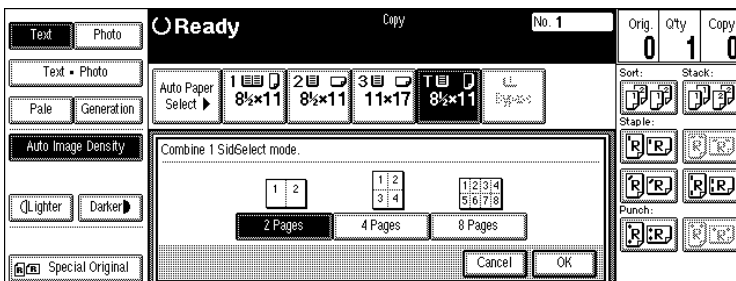

4 Check the orientation.

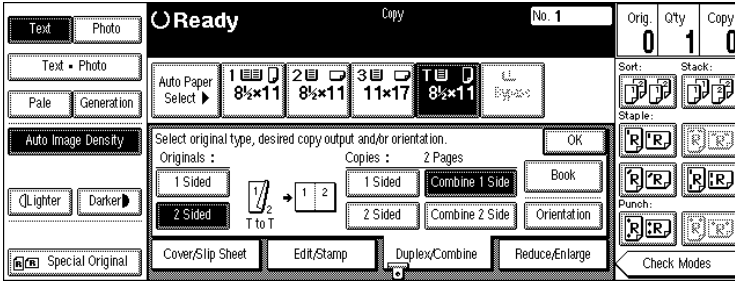

Note

- To change the copy orientation to "Top to Bottom", press the **[Orientation]** key and select **[Top to Bottom]**. See ⇒ P.110 "Specifying Orientation of Bound Originals".

5 Press the [OK] key.

6 Select the paper.

7 Set your originals, then press the [Start] key.

2 Sided 4 Pages → Combine 1 Side

Copies two 2-sided originals to one side of a sheet.

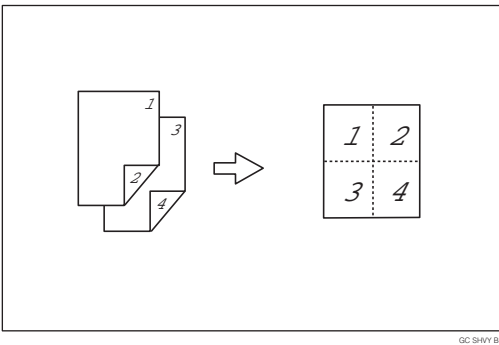

1 Press the [Duplex/Combine] key.

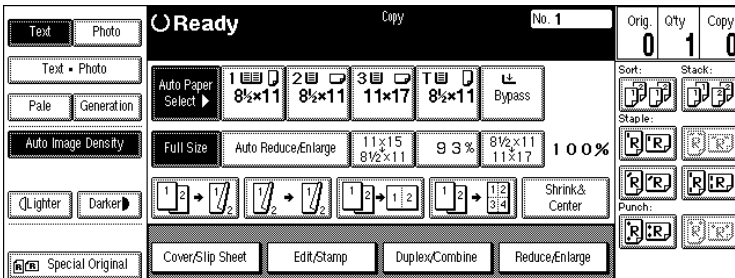

- 2** Press the [2 Sided] key for the original, then press the [Combine 1 Side] key for the copy.

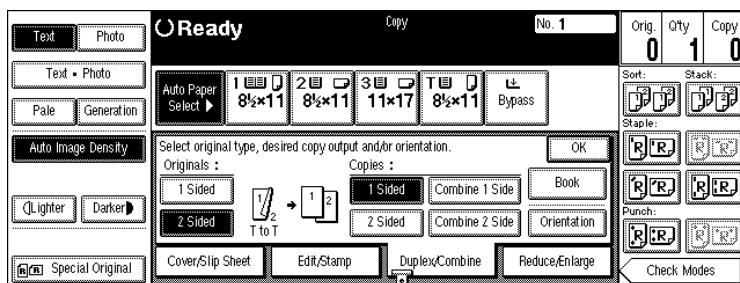

- 3** Press the [4 Pages] key, then press the [OK] key.

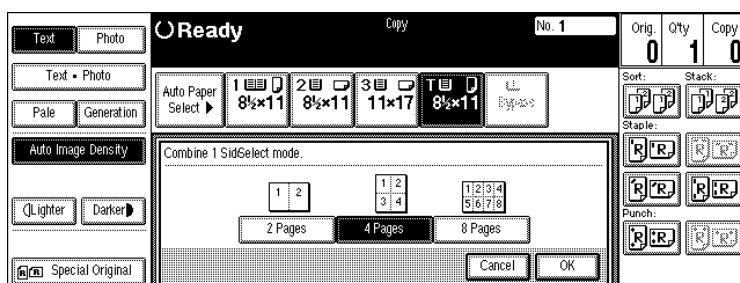

- 4** Check the orientation.

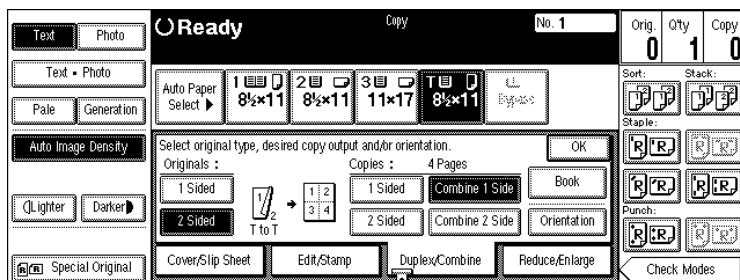

Note

- To change the copy orientation to "Top to Bottom", press the [Orientation] key and select [Top to Bottom]. See ⇒ P.110 "Specifying Orientation of Bound Originals".

- 5** Press the [OK] key.
- 6** Select the paper.
- 7** Set your originals, then press the [Start] key.

2

2 Sided 8 Pages → Combine 1 Side

Copies four 2-sided originals to one side of a sheet.

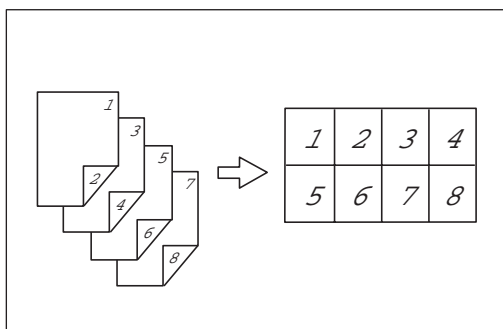

GC SHVY 4J

1 Press the [Duplex/Combine] key.

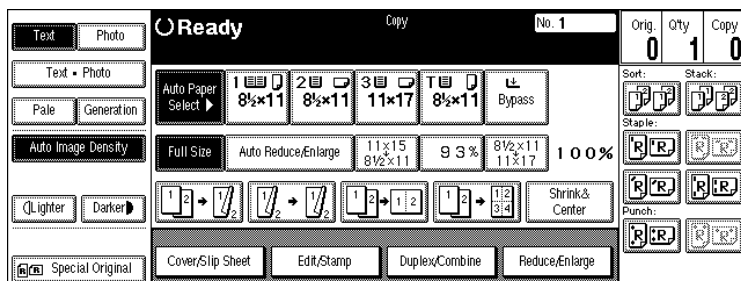

2 Press the [2 Sided] key for the original, then press the [Combine 1 Side] key for the copy.

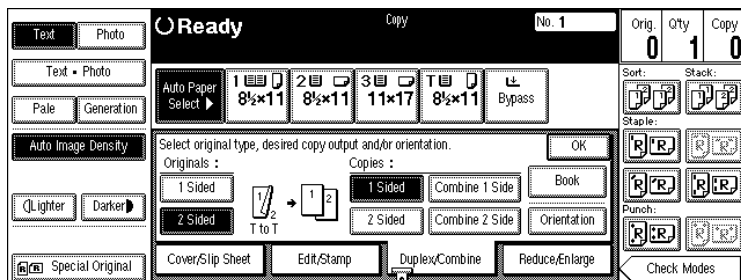

3 Press the [8 Pages] key, then press the [OK] key.

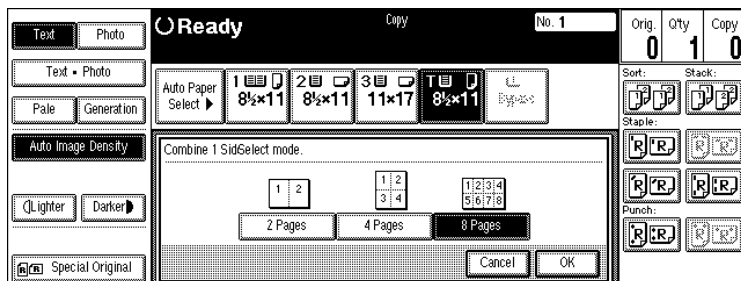

4 Check the orientation.

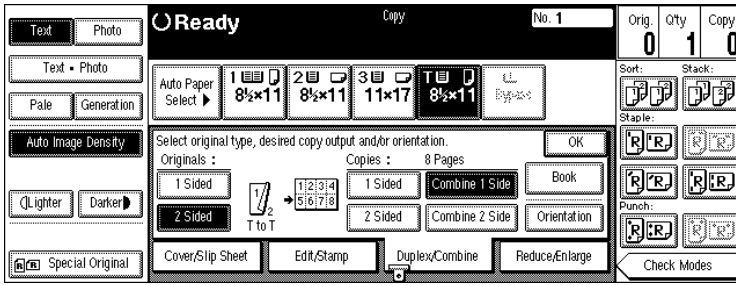

Note

- To change the copy orientation to “Top to Bottom”, press the **[Orientation]** key and select **[Top to Bottom]**. See ⇒ P.110 “Specifying Orientation of Bound Originals”.

5 Press the **[OK]** key.

6 Select the paper.

7 Set your originals, then press the **[Start]** key.

2 Sided 4 Pages → Combine 2 Side

Copies 2-sided originals together to both sides of a sheet.

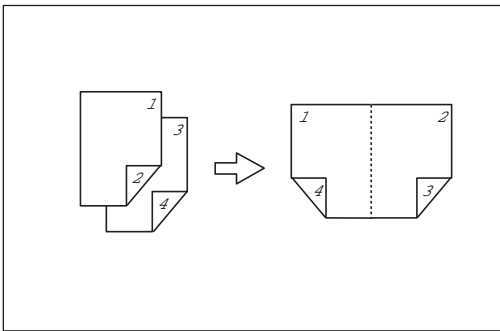

GC SHVY 1J

1 Press the **[Duplex/Combine]** key.

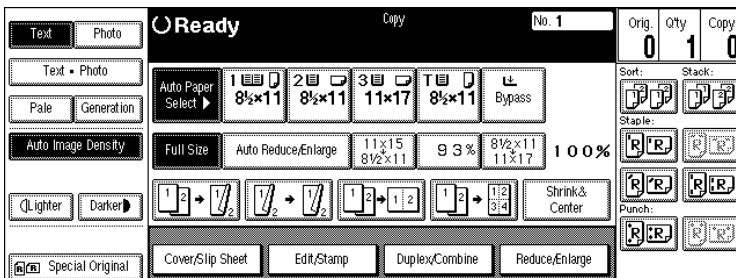

- Press the [2 Sided] key for the original, then press the [Combine 2 Side] key for the copy.

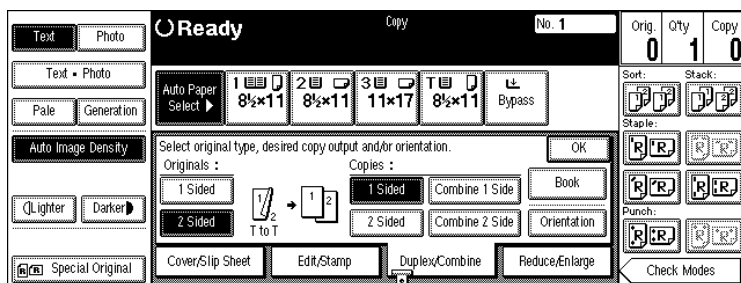

- Press the [4 Pages] key, then press the [OK] key.

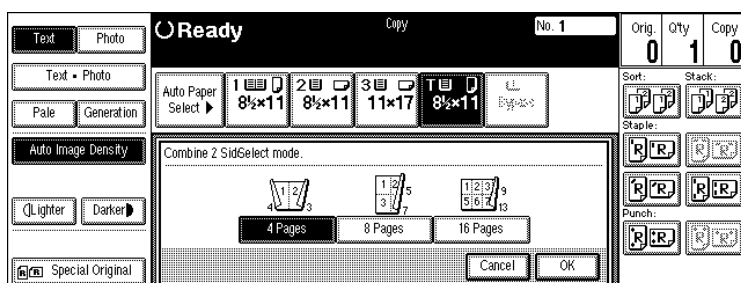

- Check the orientation.

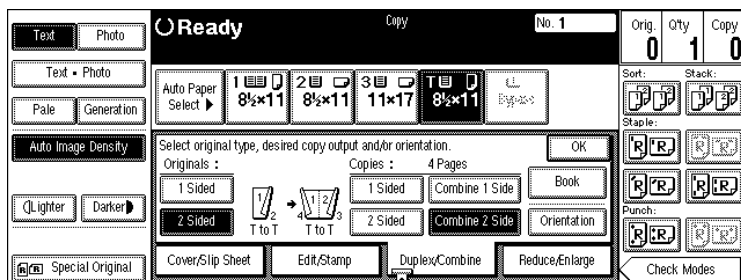

Note

- To change the copy orientation to “Top to Bottom”, press the [Orientation] key and select [Top to Bottom]. See ⇒ P.110 “Specifying Orientation of Bound Originals”.

- Press the [OK] key
- Select the paper.
- Set your originals, then press the [Start] key.

2 Sided 8 Pages → Combine 2 Side

Copies four 2-sided originals together to both sides of a sheet.

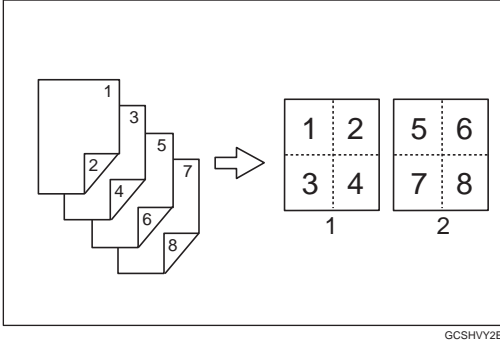

1. Front

2. Back

1 Press the [Duplex/Combine] key.

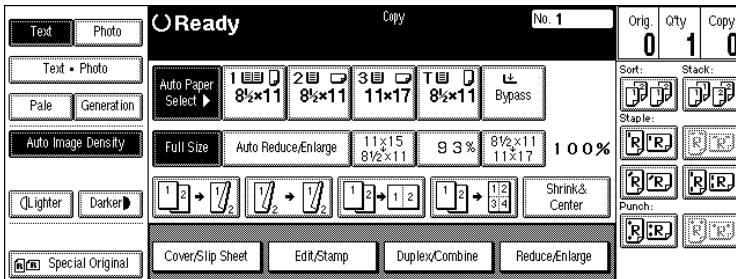

2 Press the [2 Sided] key for the original, then press the [Combine 2 Side] key for the copy.

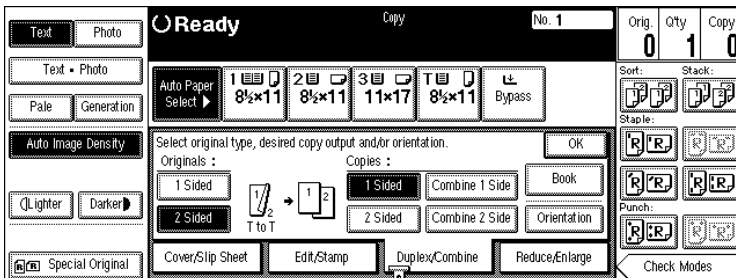

3 Press the [8 Pages] key, then press the [OK] key.

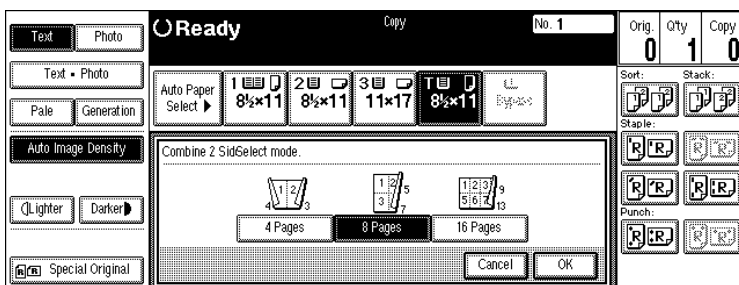

4 Check the orientation.

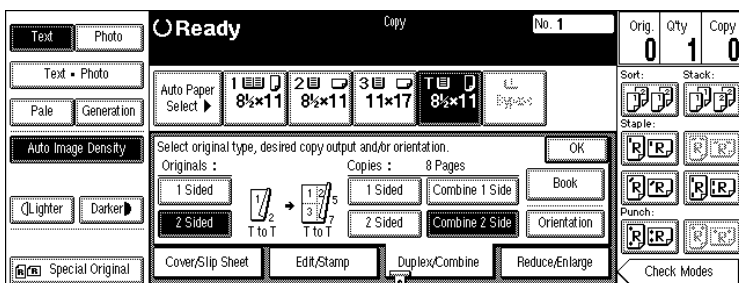

Note

To change the copy orientation to “Top to Bottom”, press the [Orientation] key and select [Top to Bottom]. See ⇒ P.110 “Specifying Orientation of Bound Originals”.

5 Press the [OK] key

6 Select the paper.

7 Set your originals, then press the [Start] key.

2 Sided 16 Pages → Combine 2 Side

Copies eight 2-sided originals together to both sides of a sheet.

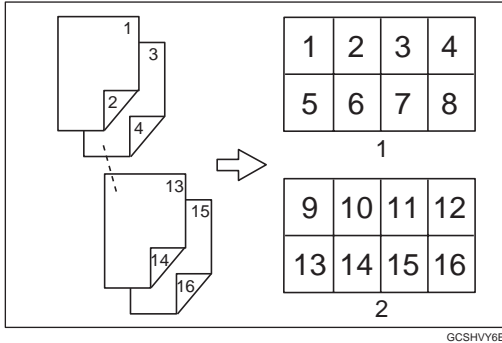

GCSHVY6E

1. Front

2. Back

1 Press the [Duplex/Combine] key.

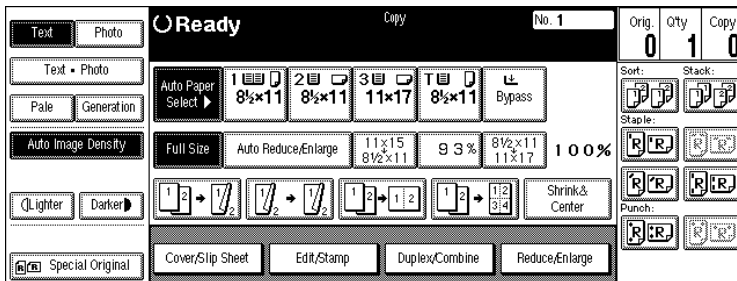

2 Press the [2 Sided] key for the original, then press the [Combine 2 Side] key for the copy.

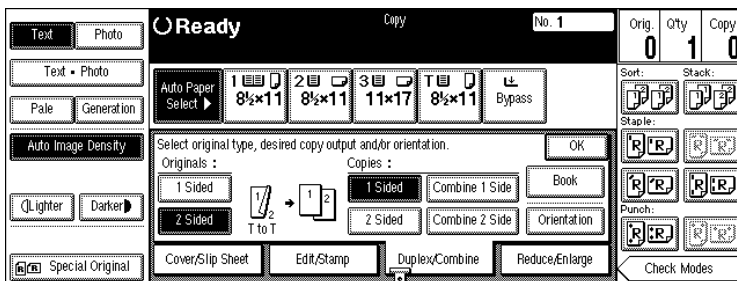

3 Press the [16 Pages] key, then press the [OK] key.

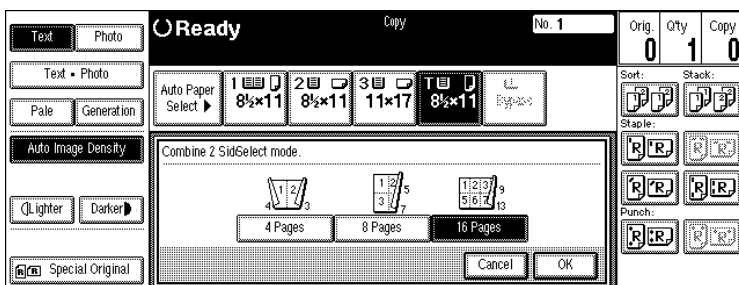

4 Check the orientation.

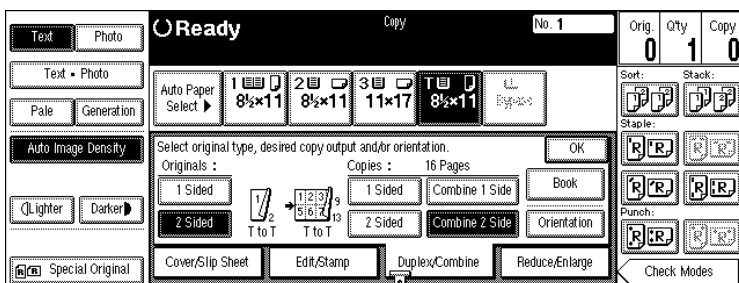

Note

To change the copy orientation to “Top to Bottom”, press the [Orientation] key and select [Top to Bottom]. See ⇒ P.110 “Specifying Orientation of Bound Originals”.

5 Press the [OK] key.

6 Select the paper.

7 Set your originals, then press the [Start] key.

Series/Book

Series copies are made by separately copying the front and back of a 2-sided original or the two facing pages of a spread original onto two sheets of paper. A book is made by copying two or more originals in page order.

The following types of Series and Book modes can be used:

Series Copies

❖ **Book → 1 Sided**

Copies the two facing pages of a spread original to make two 1-sided copies.

❖ **2 Sided → 1 Sided**

Copies the front and back of a 2-sided original to make two 1-sided copies.

Book

❖ **Book → 2 Sided**

Copies a spread two-page original onto both sides of a sheet.

❖ **Multi → 2 Sided**

Copies each spread two-page original as it is onto both sides of a sheet.

❖ **Booklet**

Make copies in page order for a folded booklet.

❖ **Magazine**

Copies two or more originals to make copies in page order (as when they are folded and stacked).

Series Copies

Book → 1 Sided

You can make one-sided copies from two facing pages of a bound original (book).

2

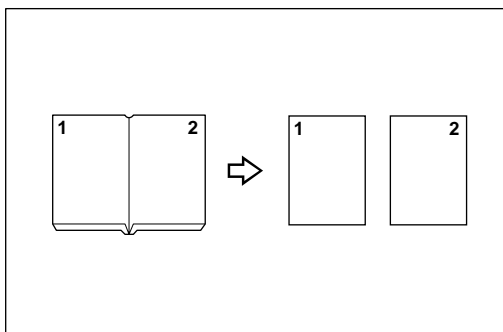

Note

See the following table when you select original and copy paper sizes with 100% ratio:

◆ **Metric version**

Original	Copy paper
A3	A4 × 2 sheets
B4	B5 × 2 sheets
A4	A5 × 2 sheets

◆ **Inch version**

Original	Copy paper
11" × 17"	8 ¹ / ₂ " × 11" × 2 sheets
8 ¹ / ₂ " × 11"	5 ¹ / ₂ " × 8 ¹ / ₂ " × 2 sheets

1 Press the [Duplex/Combine] key.

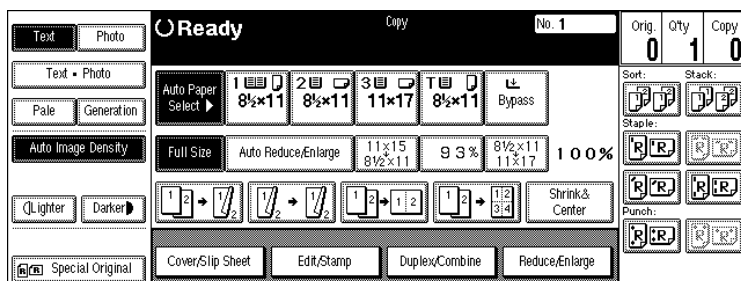

2 Press the [Book] key.

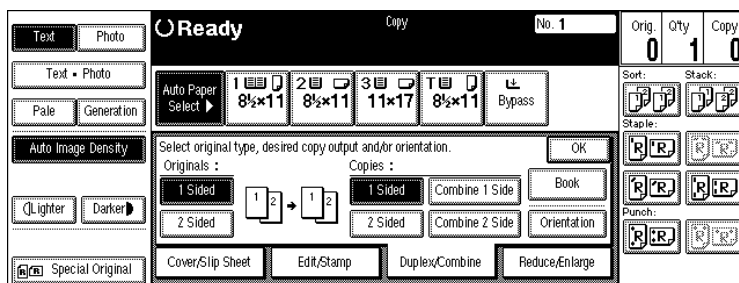

3 Press the [Book→1 Sided] key.

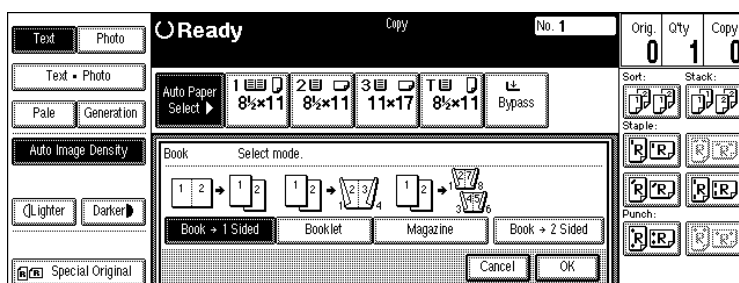

4 Press the [OK] key.

5 Press the [OK] key.

6 Make sure that the [Auto Paper Select] key is selected.

Note

- If the [Auto Paper Select] key is not selected, press the [Auto Paper Select] key.

7 Set your originals, then press the [Start] key.

2 Sided→1 Sided

You can make one-sided copies from two-sided originals.

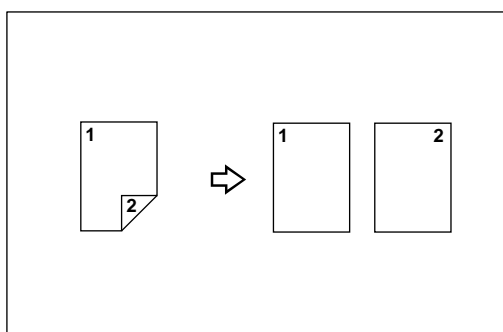

1 Press the [Duplex/Combine] key.

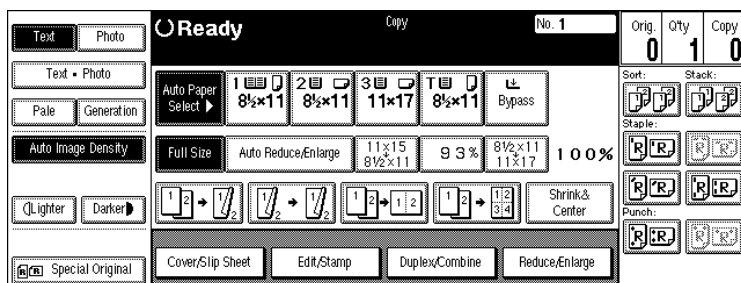

2 Press the [2 Sided] key for the original, then press the [1 Sided] key for the copy.

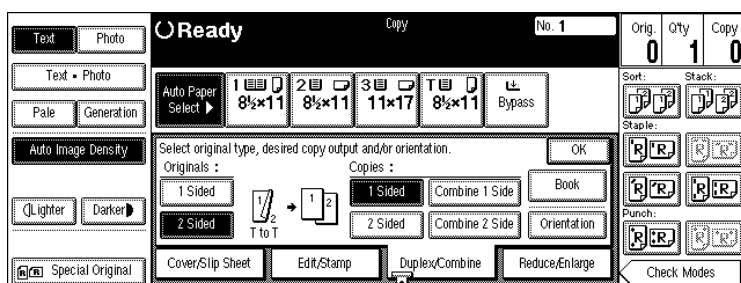

3 Check the orientation.

Note

- To change the original orientation to “Top to Bottom”, press the [Orientation] key, then select [Top to Bottom]. See ⇒ P.110 “Specifying Orientation of Bound Originals”.

4 Press the [OK] key

5 Set your originals, then press the [Start] key.

Copying Book Originals

Limitation

- You cannot use the bypass tray with this function.
- The machine cannot copy originals different in size and direction.

Note

- The machine sets the reproduction ratio automatically to meet the paper size and copies the originals together onto the paper.
- The machine uses ratios in the range of 25 to 400%.

- If the calculated ratio is under the available minimum ratio, it will be adjusted to the minimum ratio. However, with some ratios, parts of the image might not be copied.
- Even if the direction of originals is different from that of the copy paper, the machine will automatically rotate the image by 90° to make copies properly.

Book→2 Sided

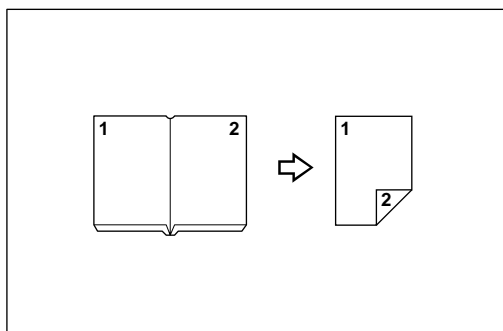

Copies a two-page spread original onto both sides of a sheet.





Note

- See the following table when you select original and copy paper sizes with 100% ratio:

◆ Metric version

Original	Copy paper
A3 	A4 (2-sided)
B4 	B5 (2-sided)
A4 	A5 (2-sided)

◆ Inch version

Original	Copy paper
11" × 17" 	8 ¹ / ₂ " × 11" (2-sided)
8 ¹ / ₂ " × 11" 	5 ¹ / ₂ " × 8 ¹ / ₂ " (2-sided)

1 Press the [Duplex/Combine] key.

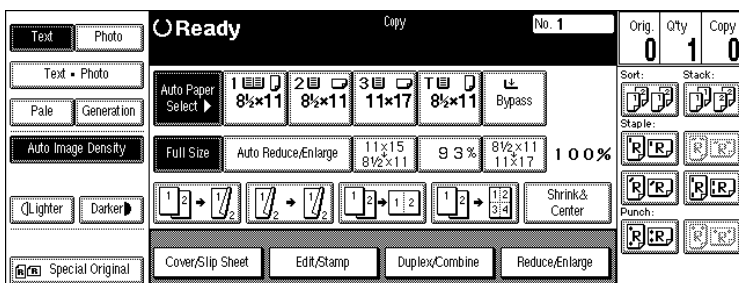

2 Press the [Book] key.

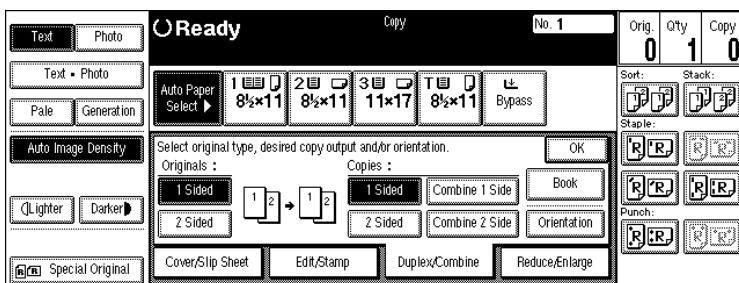

3 Press the [Book→2 Sided] key.

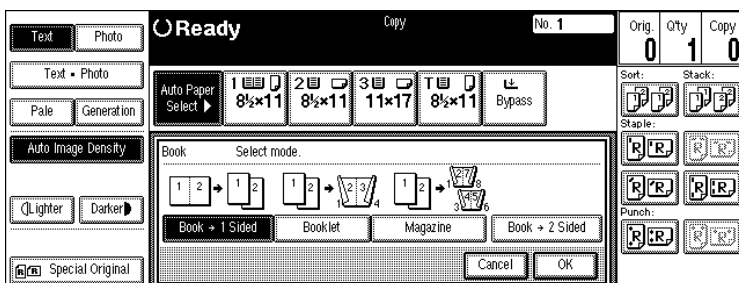

4 Press the [Book→2 Sided] key.

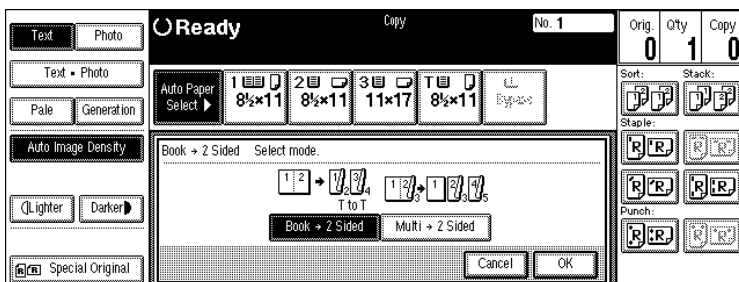

5 Press the [OK] key.

6 Select the paper.

7 Set your originals, then press the [Start] key.

Multi → 2 Sided

Copies each two-page spread original as it is onto both sides of a sheet.

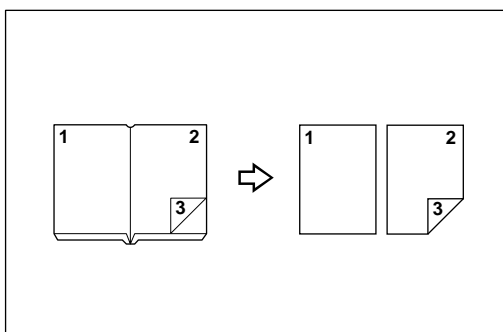

Note

- See the following table when you select original and copy paper sizes with 100% ratio:

◆ Metric version

Original	Copy paper
A3	A4 (2-sided)
B4	B5 (2-sided)
A4	A5 (2-sided)

◆ Inch version

Original	Copy paper
11" × 17"	8 ¹ / ₂ " × 11" (2-sided)
8 ¹ / ₂ " × 11"	5 ¹ / ₂ " × 8 ¹ / ₂ " (2-sided)

1 Press the [Duplex/Combine] key.

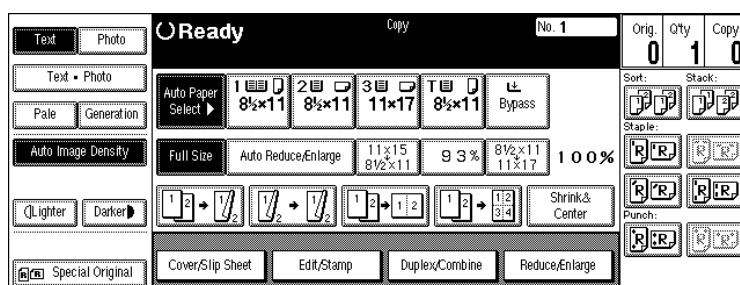

2 Press the [Book] key.

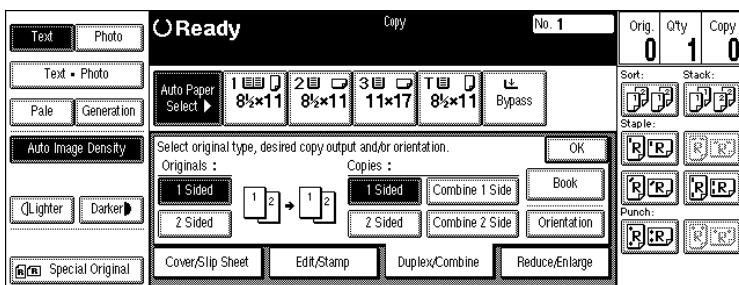

3 Press the [Book→2 Sided] key.

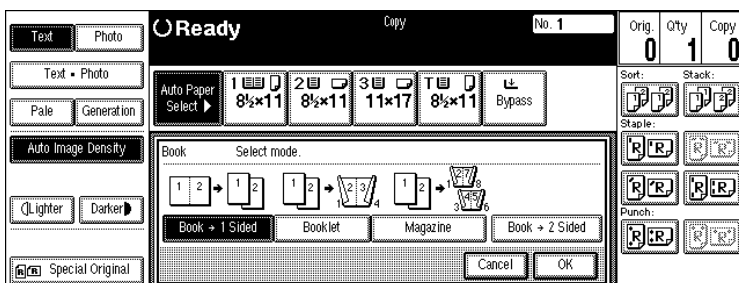

4 Press the [Multi→2 Sided] key.

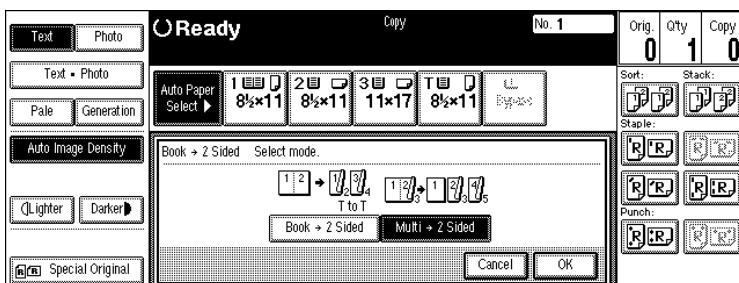

5 Press the [OK] key.

6 Select the paper.

7 Set your originals, then press the [Start] key.

Note

- ❑ When placing one original on the exposure glass or in the document feeder in Batch (SADF) mode, press the [#] key after all originals are scanned.

Booklet

Make copies in page order for a folded booklet as shown in the following illustrations:

❖ Portrait

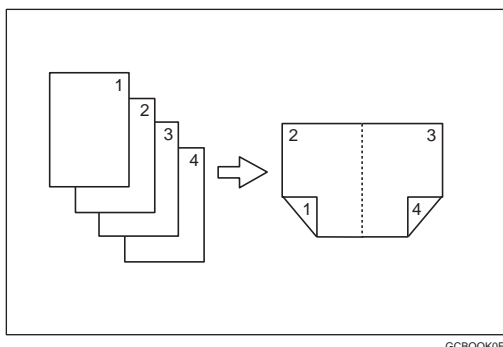

GCB00K0E

❖ Landscape

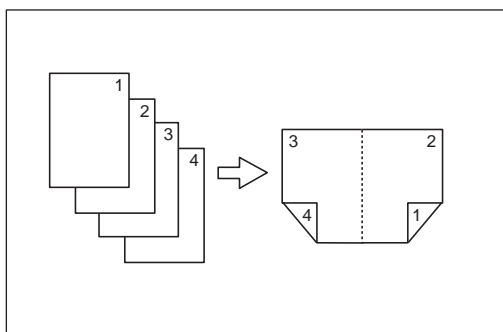

GCB00K1E

🔔 Important

- ❑ Before selecting this function, select “Portrait” or “Landscape” with the User Tools. See “Booklet/Magazine Original Orientation” in ⇒ P.320 “Page Format 2/2”.

📝 Note

- ❑ Four originals are copied onto each sheet of copy paper.
- ❑ In this mode, the machine sets the reproduction ratio automatically to meet the paper size and copies the originals together onto the paper.
- ❑ A ratio is selected in the range of 25 to 400%.
- ❑ If the calculated ratio is under the available minimum ratio, it will be adjusted to the minimum ratio. However, with some ratios, parts of the image might not be copied.
- ❑ If the number of originals scanned is less than a multiple of 4, the last page is copied blank.
- ❑ You can have a 3mm, 0.1" bounding margin around all four edges of the original left blank (erased). See “Combine Orig. Shadow Erase” in ⇒ P.317 “Page Format 1/2”.

How to fold copies to make a booklet

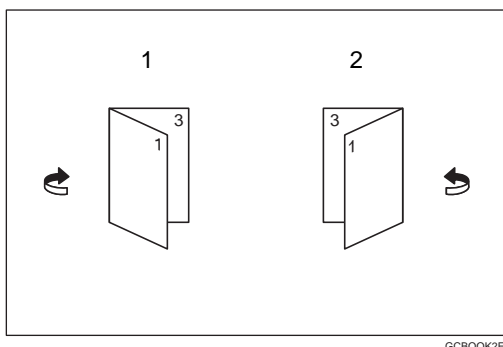

GCBOOK2E

1. Portrait

2. Landscape

1 Press the [Duplex/Combine] key.

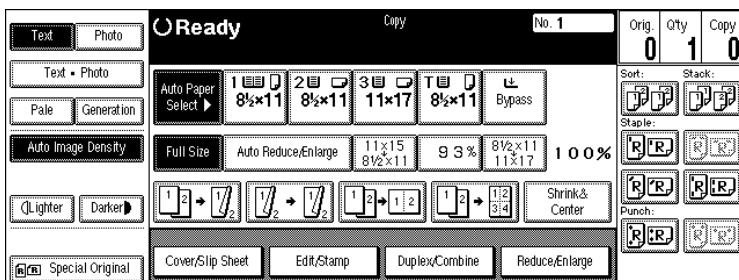

2 Press the [Book] key.

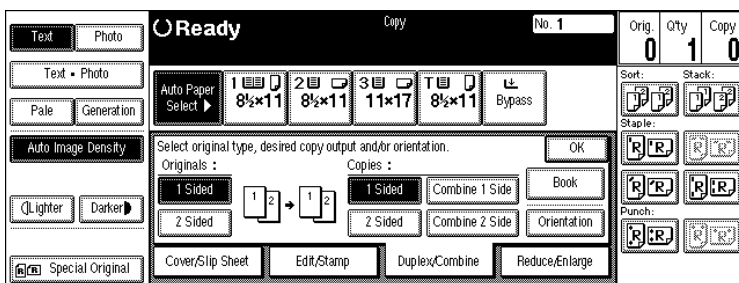

3 Press the [Booklet] key, followed by the [OK] key.

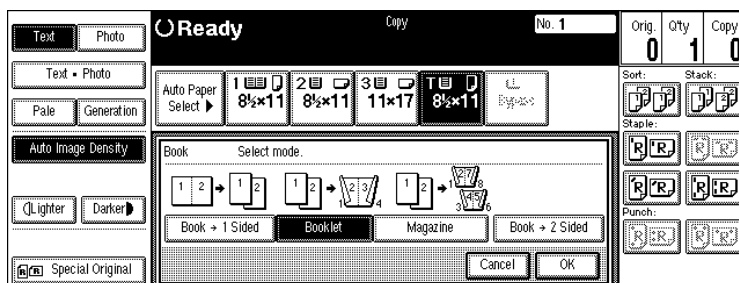

4 Select the paper.

5 Set your originals, then press the [Start] key.

Note

- When placing one original on the exposure glass or in the document feeder in Batch (SADF) mode, press the [#] key after all originals are scanned.

Magazine

Copies two or more originals to make copies in page order when they are folded and stacked.

❖ Portrait

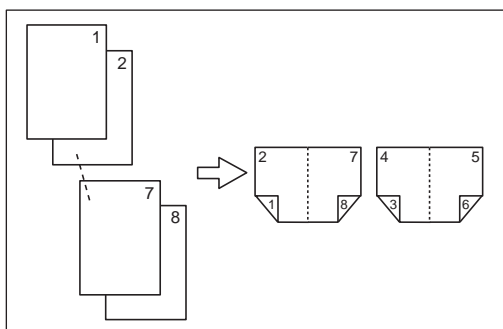

GCBOOK3E

❖ Landscape

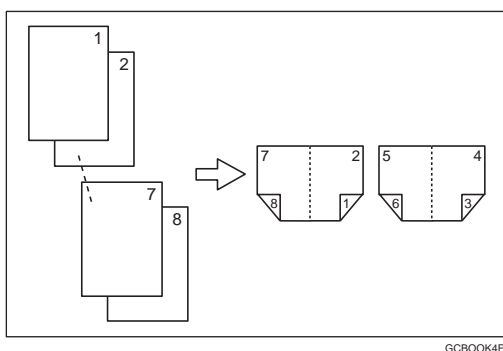

GCBOOK4E

⚠ Important

- ❑ Before selecting this function, select "Portrait" or "Landscape" with the User Tools. See "Booklet/Magazine Original Orientation" in ⇒ P.320 "Page Format $\frac{2}{2}$ ".

📝 Note

- ❑ To use this function with two-sided originals, select this function from the Shortcut Keys. See "Shortcut Keys" in ⇒ P.314 "General Features $\frac{3}{3}$ ".
- ❑ Four originals are copied onto each sheet of copy paper.
- ❑ In this mode, the machine sets the reproduction ratio automatically to meet the paper size and copies the originals together onto the paper.
- ❑ A ratio is selected in the range of 25 to 400%.
- ❑ If the calculated ratio is under the available minimum ratio, it will be adjusted to the minimum ratio. However, with some ratios, parts of the image might not be copied.
- ❑ If the number of originals scanned is less than a multiple of 4, the last page is copied blank.
- ❑ You can have a 3mm bounding margin around all four edges of the original left blank (erased). See "Combine Orig. Shadow Erase" in ⇒ P.317 "Page Format $\frac{1}{2}$ ".
- ❑ The copying may take some time after scanning originals.

How to fold and unfold copies to make a magazine

❖ Portrait

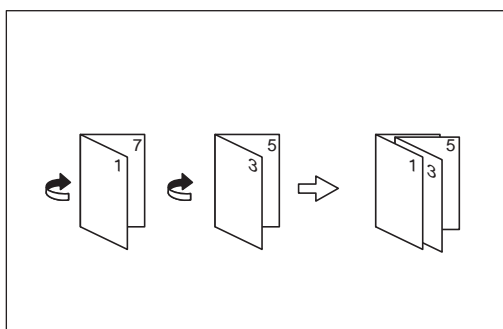

GCBOOK5E

❖ Landscape

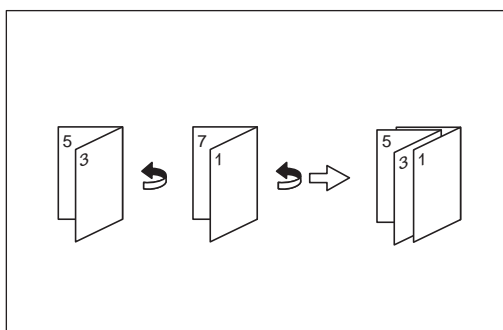

GCBOOK6E

📌 Note

- ❑ If you select “Saddle Stitch” with the optional booklet finisher in Magazine mode, the machine staples the paper, and folds it like a book, then delivers the folded pages.

📌 Limitation

- ❑ If you select “Saddle Stitch” with the optional booklet finisher in Magazine mode when the number of originals is only one, the original image is copied onto the second page of the copy paper.

1 Press the [Duplex/Combine] key.

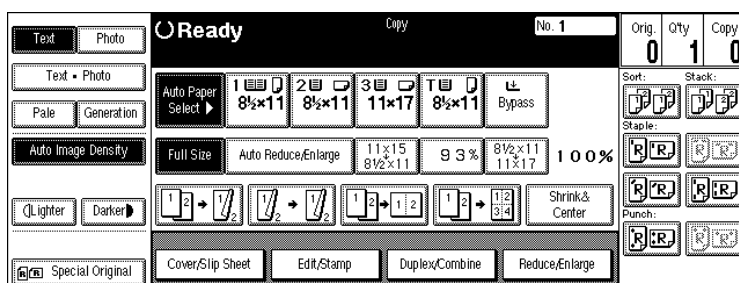

2 Press the [Book] key.

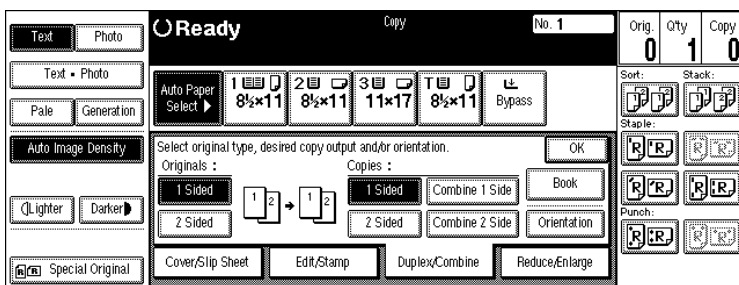

3 Press the [Magazine] key, followed by the [OK] key.

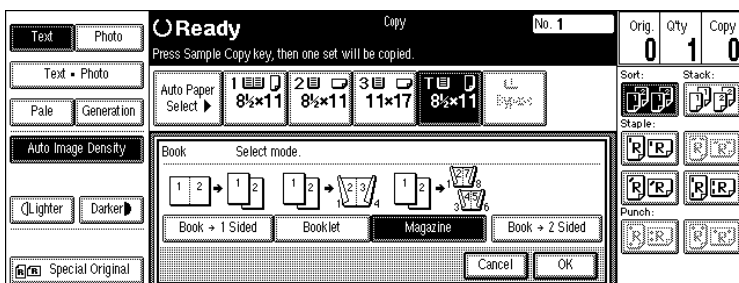

4 Select the paper.

5 Set your originals, then press the [Start] key.

Note

- When placing one original on the exposure glass or in the document feeder in Batch (SADF) mode, press the [#] key after all originals are scanned.

Cover/Slip Sheet

Using this function, you can add or insert cover or paper designate.

There are four types in this function:

❖ Front Cover

The first page of your originals is copied on a specific paper sheet for covers.

❖ Front/Back Covers

The first and last pages of your originals are copied on specific paper sheets for covers.

❖ Paper Designate

Use this function to have certain pages of your original copied onto slip sheets.

❖ Chapters

If you specify the first page of each chapter with this function, those pages will always appear on the front of copies when using 1 sided → 2 sided mode.

Preparation

Before selecting this function, set the tray for front cover paper and slip sheet paper. See “Cover”, “Slip Sheet 1” and “Slip Sheet 2” in the System Settings manual.

The cover or slip sheets should be identical in size and direction with the copy paper.

Limitation

- You cannot set the copy paper in the bypass tray. Only set the cover or slip sheets in the bypass tray.

Note

- If Blank mode is selected, the cover will not be counted as a copy.

Front Cover

The first page of your originals is copied on specific paper sheet for covers, or a cover sheet is inserted before the first copy.

❖ Copy

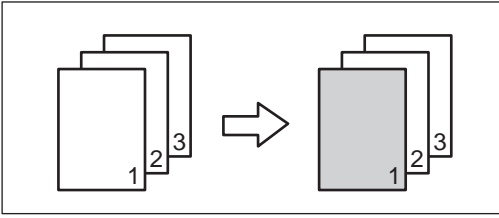

❖ Blank

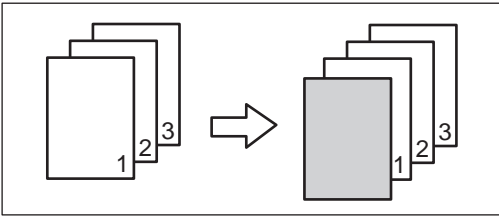

Note

- ❑ You can specify whether to make a copy on a sheet for covers. If you select **[Copy]**, the first page will be copied on the cover sheet. If you select **[Blank]**, a cover sheet will just be inserted before the first copy.
- ❑ When choosing **[Copy]**, select whether the front and back covers are copied single-sided (“1 Sided Only”) or double-sided (“Duplex Copy”). See “Cover” in the System Settings manual.
- ❑ In “Cover” of the User Tools (System Settings), if you selected “Mode Selected” for “Tray Display” setting, the machine refers to the settings in “Cover” about whether the front and back covers are copied single-sided (“1 Sided Only”) or double-sided (“Duplex Copy”). If you selected “Display Always” for “Tray Display”, the machine refers to the settings in “Special Paper Indication” about whether the front and back covers are copied single-sided (“1 Sided Copy”) or double-sided (“Duplex Copy”). See “Special Paper Indication” and “Cover” in the System Settings manual.
- ❑ When you use this function with Combine mode, you can specify whether to combine the front cover or not. See “Cover page in combine mode” in ⇒ P.320 “Page Format 2/2”.

1 Press the **[Cover/Slip Sheet]** key.

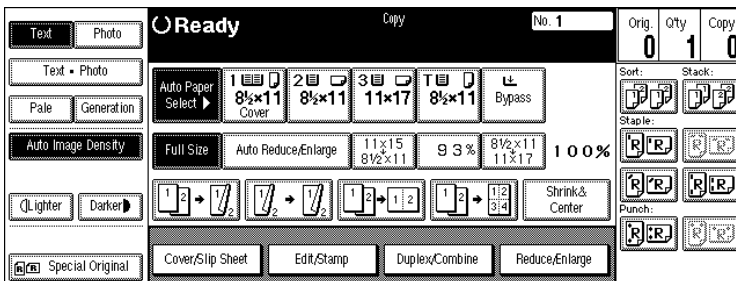

2 Press the [Front Cover] key.

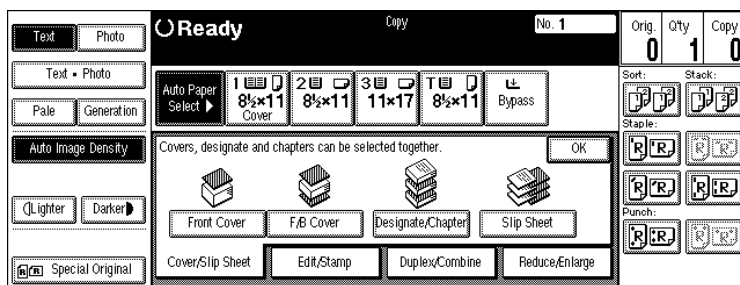

3 Select [Copy] or [Blank] for a cover sheet, and then press the [OK] key.

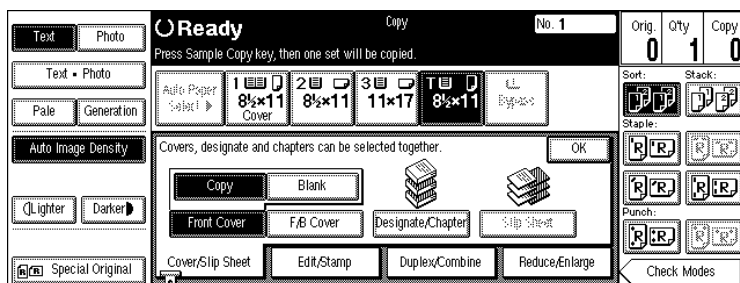

4 Select the paper tray containing the non-cover sheet paper.

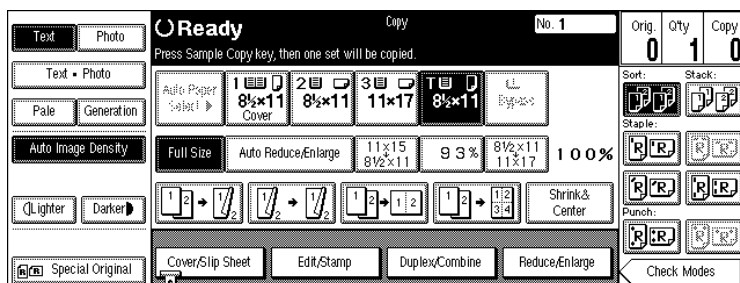

5 Set your originals in the document feeder, then press the [Start] key.

2

Front/Back Covers

The first and last pages of your originals are copied on specific paper sheets for covers.

❖ Copy

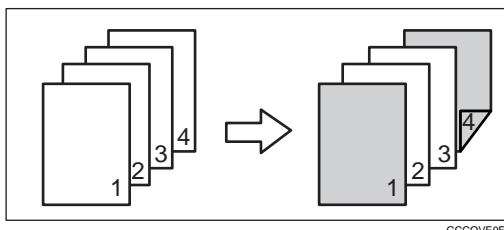

❖ Blank

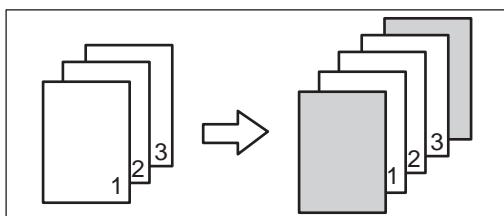

📌 Note

- ❑ You can specify whether to make a copy on a cover sheet. If you select **[Copy]**, the first and last pages will be copied on the cover sheets. If you select **[Blank]**, a cover sheet will just be inserted before the first copy and another sheet after the last copy.
- ❑ When choosing **[Copy]**, select whether the front and back covers are copied single-sided (“1 Sided Only”) or double-sided (“Duplex Copy”). See “Cover” in the System Settings manual.
- ❑ In “Cover” of the User Tools (System Settings), if you selected “Mode Selected” for “Tray Display” setting, the machine refers to the settings in “Cover” about whether the front and back covers are copied single-sided (“1 Sided Only”) or double-sided (“Duplex Copy”). If you selected “Display Always” for “Tray Display”, the machine refers to the settings in “Special Paper Indication” about whether the front and back covers are copied single-sided (“1 Sided Copy”) or double-sided (“Duplex Copy”). See “Special Paper Indication” and “Cover” in the System Settings manual.
- ❑ When making a 1-sided cover copy, you can specify whether to issue the back cover outside (outside page) or inside (inside page). See “Copy Back Cover” in ⇒ P.320 “Page Format $2/2$ ”.

1 Press the [Cover/Slip Sheet] key.

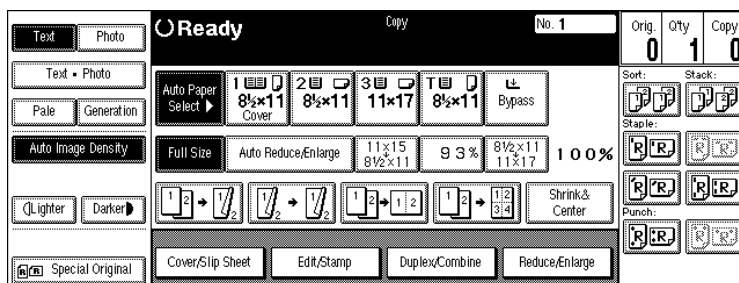

2 Press the [F/B Cover] key.

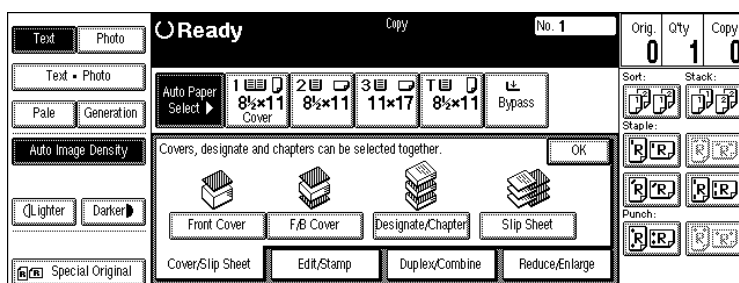

3 Select [Copy] or [Blank] for the cover sheets, and then press the [OK] key.

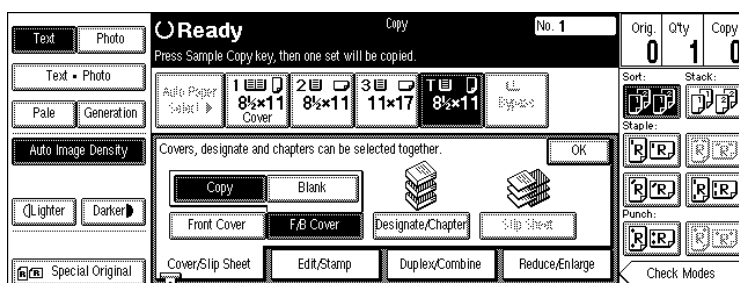

4 Select the paper tray containing the non-cover sheet paper.

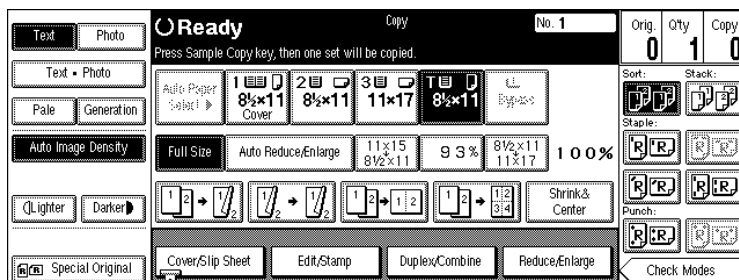

5 Set your originals in the document feeder, then press the [Start] key.

2

Designate

Use this function to have certain pages of your original copied onto slip sheets.

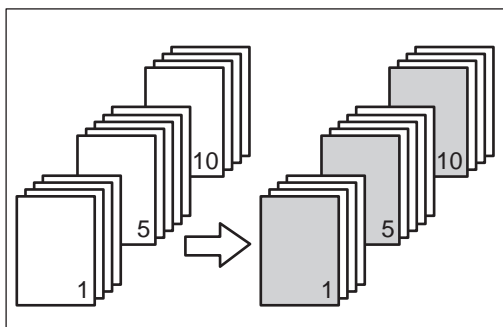

Preparation

Before using this function, set the special paper tray for slip sheets. See “Slip Sheet 1”, “Slip Sheet 2” in the System Settings manual.

Limitation

- You cannot use this function with Slip Sheet mode.

Note

- You can specify the pages up to 20.
- When Combine mode (“1 Sided → 2 Sided”) has been selected, the page numbers you designate will always be copied onto the front of copies in the same way as Chapters mode.

1 Press the [Cover/Slip Sheet] key.

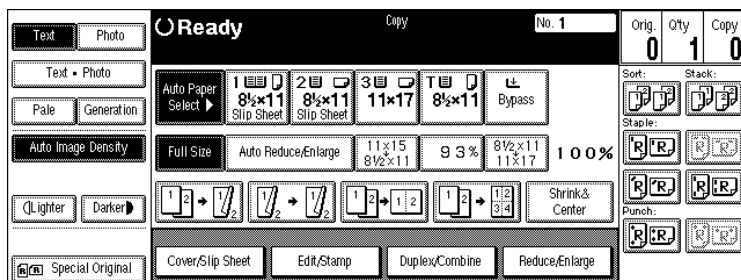

2 Press the [Designate/Chapter] key.

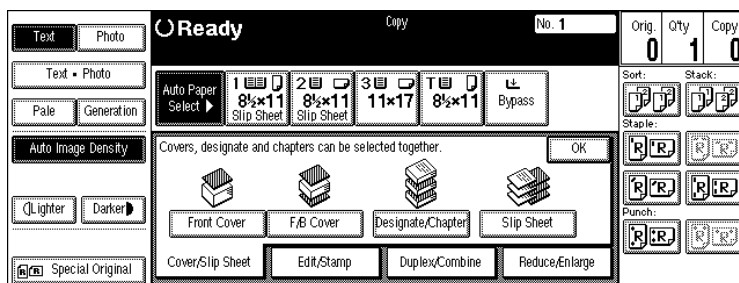

3 Press the key to select the chapter number.

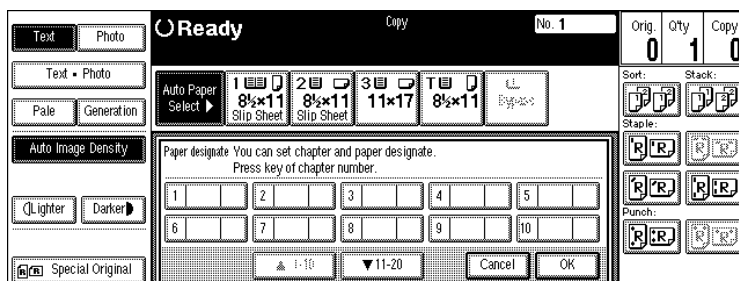

4 Enter the page number of the original's location you want to copy onto a slip sheet with the number keys. Then, press the [#] key.

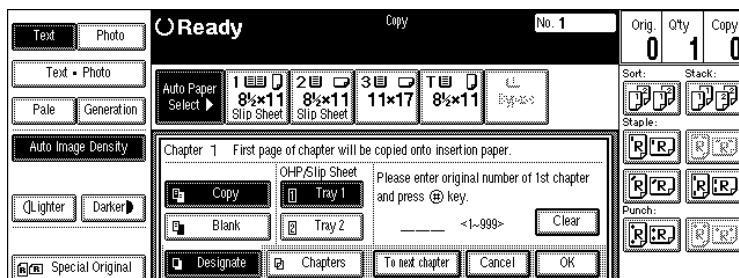

Note

- To change the value entered, press the [Clear] or [Clear/Stop] key and enter the new value.

5 Select [Copy] or [Blank] for a slip sheet.

6 Select the paper tray for slip sheets.

7 Press the [OK] key.

Note

- To display the settings for the next chapter, press the [To next chapter] key.

8 To specify another page location, repeat steps 3 to 7.

Note

- To select chapters 11 to 20, press the [▼11-20] key.

9 When you wish to finish specifying page location, press the [OK] key.

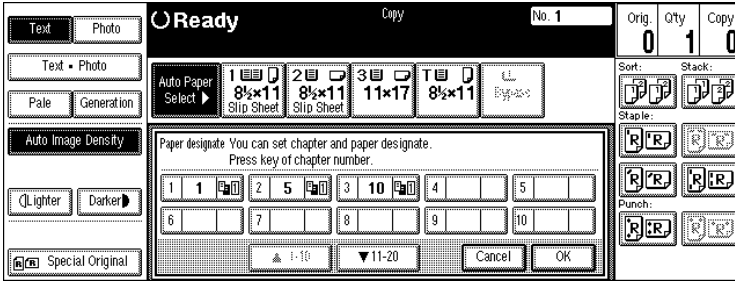

This display shows example settings.

Note

- To change the number entered, enter the new number in the same way as steps **3** to **7**.

10 Select the paper tray containing the non-slip sheet paper.

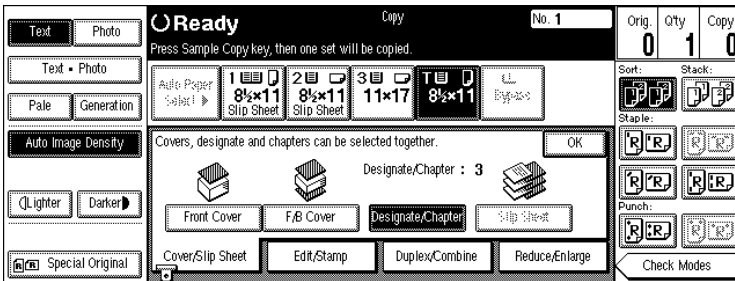

11 Set your originals, then press the [Start] key.

Chapters

The page locations you specify with this function will appear on the front of copy sheets.

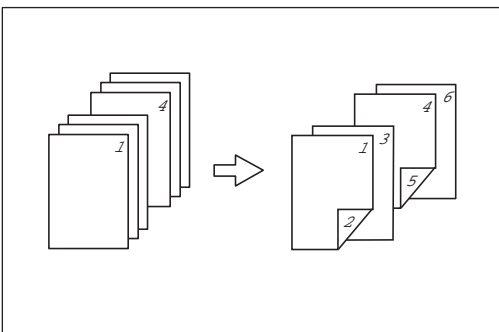

GC SHOW 0J

Preparation

Before selecting this function, press the **[Duplex/Combine]** key and select Duplex (1 Sided → 2 Sided) mode or Combine mode.

Limitation

- ❑ You cannot use this function with Slip Sheet mode.

Note

- ❑ You can specify the pages up to 20.
- ❑ This function can be used only when you use the Duplex (1 Sided→2 Sided) or Combine function.
- ❑ This function can be combined with the Designate function.

1 Press the **[Cover/Slip Sheet]** key.

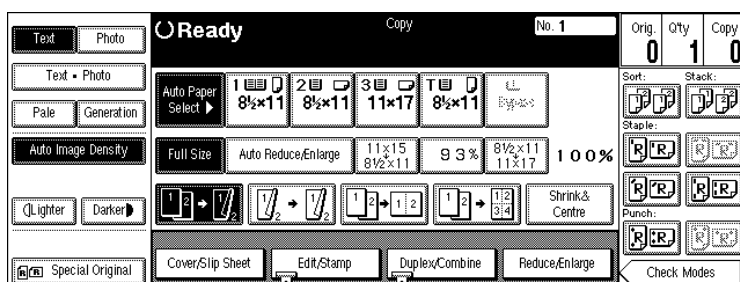

2 Press the **[Designate/Chapter]** key.

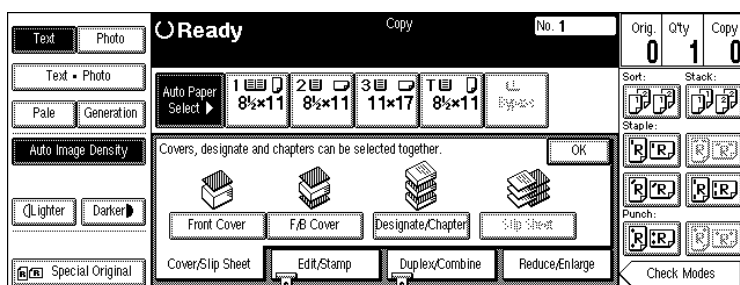

3 Press the key to select the chapter number.

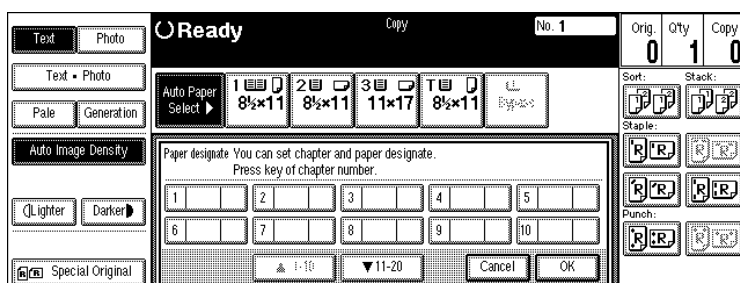

Note

- ❑ To select chapters 11 to 20, press the **[▼11-20]** key.

4 Press the [Chapters] key.

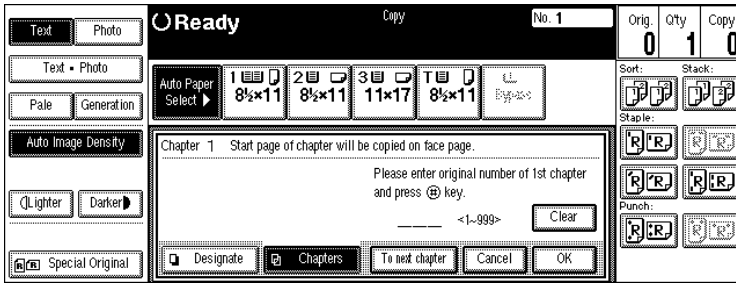

5 Enter the page location of the first page of the first chapter with the number keys. Then, press the [#] key.

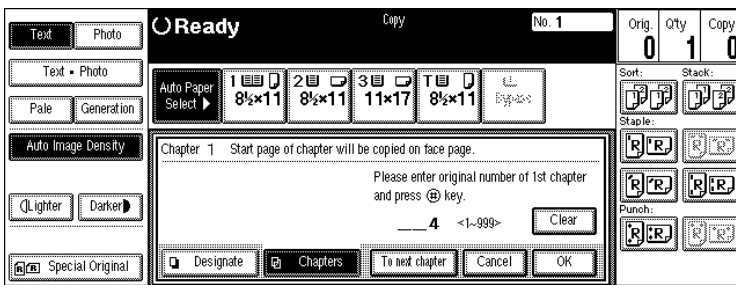

Note

- To change the value entered, press the [Clear] or [Clear/Stop] key and enter the new value.

6 Press the [OK] key.

Note

- To display the settings for the next chapter, press the [To next chapter] key before pressing the [OK] key.

7 To specify another page location, repeat steps 3 to 6.

Note

- To select chapters 11 to 20, press the [▼11-20] key.

8 When you finish specifying the page location, press the [OK] key.

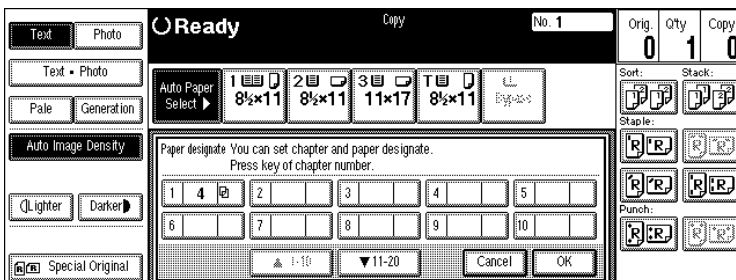

This display shows example settings.

 **Note**

- To change the number entered, enter the new number in the same way as in steps **3** to **6**.

9 Set your originals, then press the **[Start]** key.

Slip Sheets

Every time the original's page changes, a slip sheet is inserted. This function can be used to insert a slip sheet automatically between each OHP transparency copied or used as a stack function. You can also copy onto the inserted slip sheets.

2

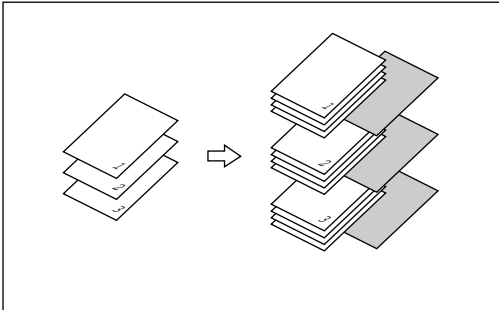

 **Preparation**

Before selecting this function, specify the paper tray for slip sheets. See “Slip Sheet 1”, “Slip Sheet 2” in the System Settings manual.

 **Limitation**

- You cannot use this function with Chapters and Paper Designate modes.
- In Connect Copy mode, you cannot use the non-standard size paper.

 **Note**

- Set the slip sheets in the same orientation as originals.
- You can specify whether to make copies onto the inserted slip sheets or not.
- If you do not copy onto slip sheets, they are excluded from the number of copies counted.
- In Connect Copy mode, specify the paper settings before you press the **[Connect]** key.

When using OHP transparencies set on the bypass tray

 **Blank**

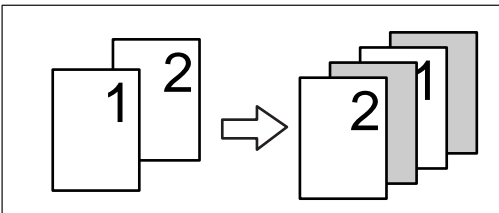

Limitation

- When copying two or more originals using the bypass tray, the copies are delivered in the reversed page order.

Note

- Press the [#] key and set the “Special Paper” setting to [OHP]. See ⇒ P.76 “When Copying onto OHP Transparencies or Thick Paper”.
- When you select [OHP], copy paper is delivered face up even if you have set the “Face-Up/Down Selection in Bypass Mode” setting to “Face Down Exit”. See “Face-Up/Down Selection in Bypass Mode” in ⇒ P.331 “Count Manager”.

1 Press the [Cover/Slip Sheet] key.

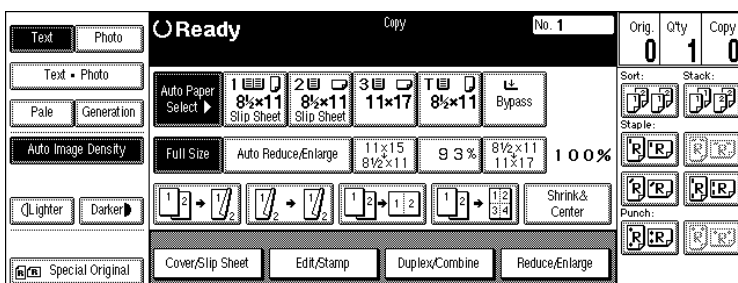

2 Press the [Slip Sheet] key.

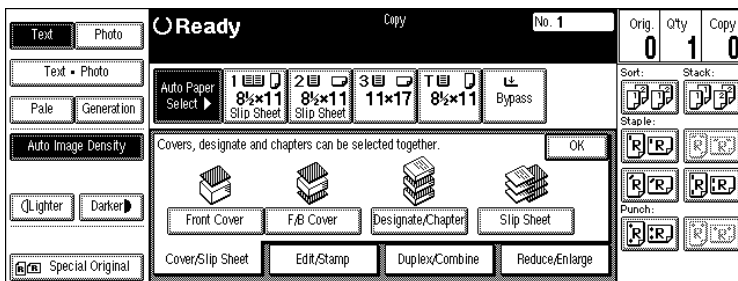

3 Select [Copy] or [Blank], followed by the [OK] key.

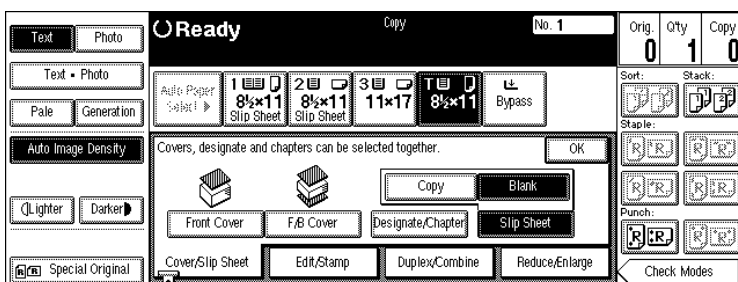

4 Select the paper tray containing the non-slip sheet paper.

When using OHP transparencies, open the bypass tray.

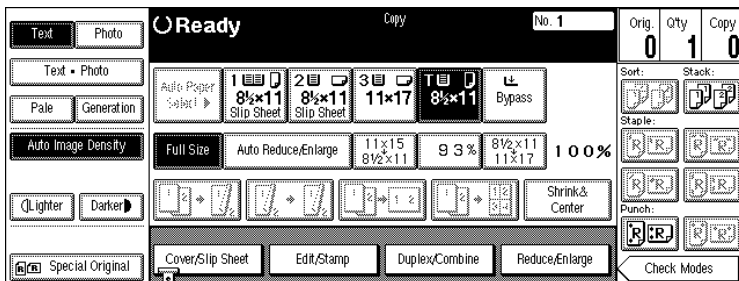
**5** Set your originals, then press the **[Start]** key.

Double Copies

One original image is copied twice on one copy as shown in the illustration.

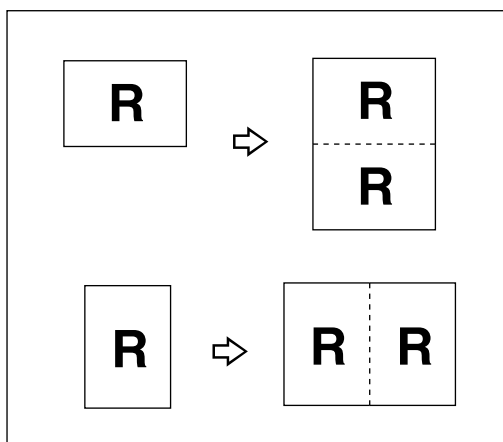

2

! Limitation

- The following originals cannot be detected properly on the exposure glass. Be sure to select the copy paper manually or set the originals in the document feeder.

Metric version	A5 <input type="checkbox"/> , B6 <input type="checkbox"/> <input type="checkbox"/>
Inch version	5 ¹ / ₂ " × 8 ¹ / ₂ " <input type="checkbox"/>

- You cannot use the bypass tray with this function.







✎ Note

- You can insert separation lines between repeated images. See "Double Copies Separation Line" in ⇒ P.320 "Page Format ²/₂".
- See the following table when you select original and copy paper sizes with 100% ratio:

❖ Metric version

Original Size and Direction	Copy Paper Size and Direction
A5 <input type="checkbox"/>	A4 <input type="checkbox"/>
B6 <input type="checkbox"/>	B5 <input type="checkbox"/>
A4 <input type="checkbox"/>	A3 <input type="checkbox"/>
A5 <input type="checkbox"/>	A4 <input type="checkbox"/>
B6 <input type="checkbox"/>	B5 <input type="checkbox"/>

❖ Inch version

Original Size and Direction	Copy Paper Size and Direction
5 ¹ / ₂ " × 8 ¹ / ₂ " 	8 ¹ / ₂ " × 11" 
5 ¹ / ₂ " × 8 ¹ / ₂ " 	8 ¹ / ₂ " × 11" 
8 ¹ / ₂ " × 11" 	11" × 17" 

1 Press the [Edit/Stamp] key.

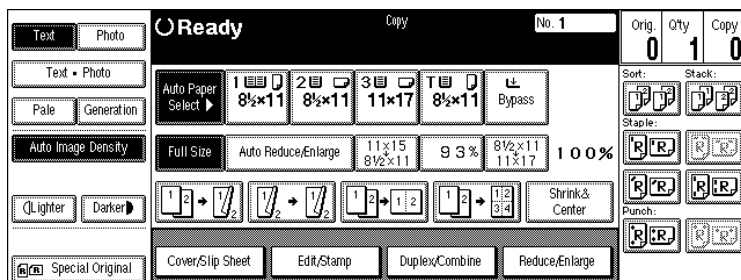

2 Press the [Double] key.

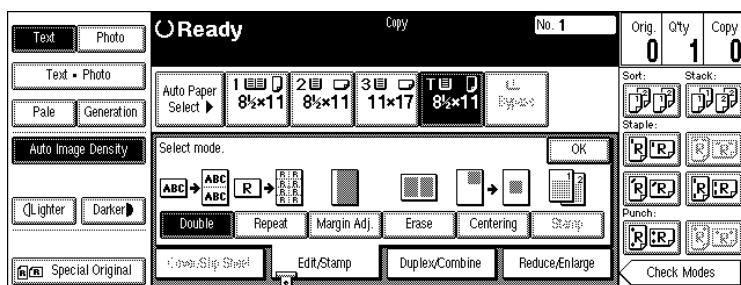

3 Press the [OK] key.

4 Select the paper.

5 Set your originals, then press the [Start] key.

Image Repeat

The original image is copied repeatedly.

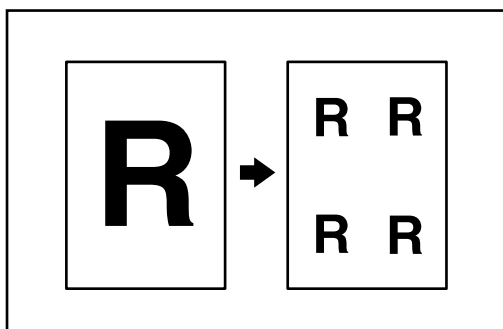

Note

- ❑ The number of repeated images depends on the original size, copy paper size, and reproduction ratio. See the following table:

❖ Original: A5  /Copy paper: A4  or Original: A5  /Copy paper A4 

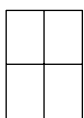
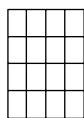
4 repeats (71%)	16 repeats (35%)
 Repeat1	 Repeat2

❖ Original: A5  /Copy paper: A4  or Original: A5  /Copy paper A4 

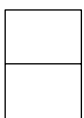
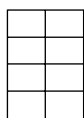
2 repeats (100%)	8 repeats (50%)
 Repeat3	 Repeat4

- ❑ Part of a repeated image might not be copied depending on copy paper size, copy paper direction or reproduction ratio.
- ❑ You can insert separation lines between repeated images. See “Repeat Separation Line” in ⇒ P.317 “Page Format $1/2$ ”.
- ❑ You can select the area of the images to be repeated. See ⇒ P.169 “To repeat the image of the selected area”.

1 Select the size of the copy paper and the reproduction ratio.

2 Press the [Edit/Stamp] key.

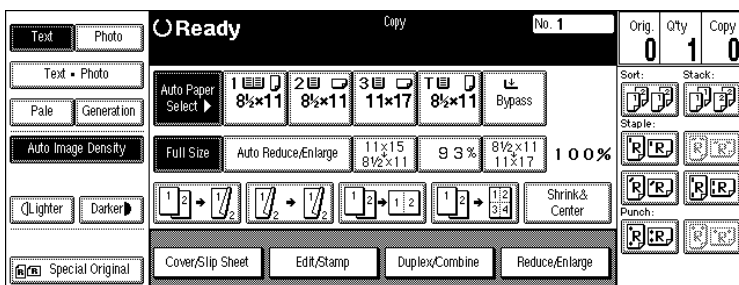

3 Press the [Repeat] key.

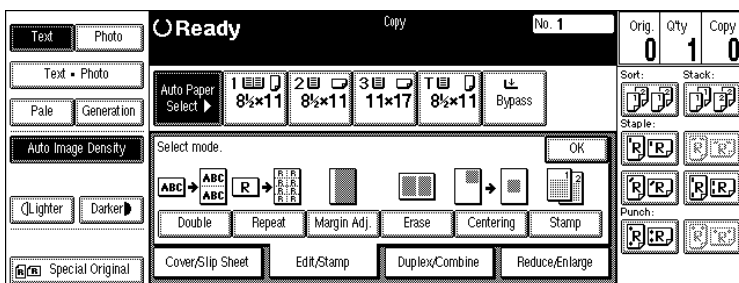

4 Specify the area to be repeated.

To repeat the whole image of the original

1 Press the [All area] key.

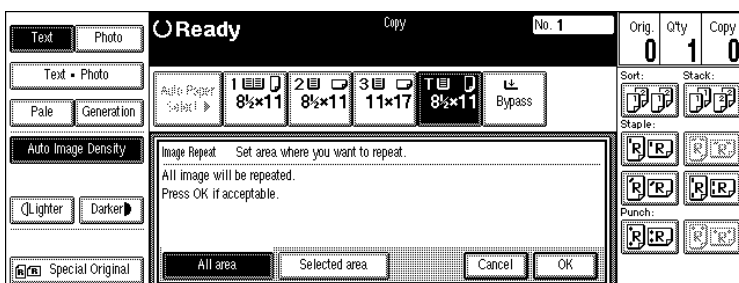

To repeat the image of the selected area

1 Press the **[Selected area]** key.

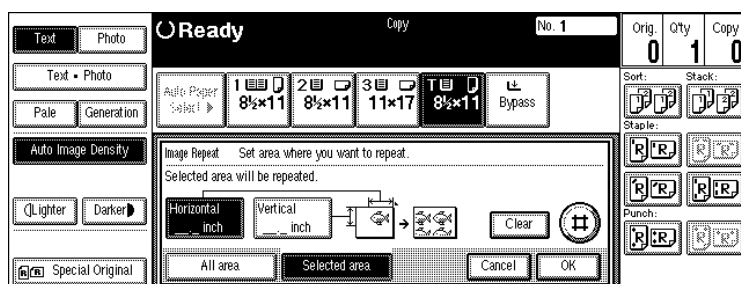

2 Enter the horizontal size of the area with the number keys, then press the **[#]** key.

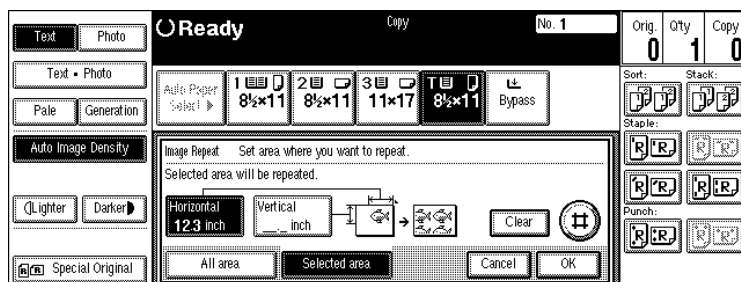

Note

- To change the number entered, press the **[Clear]** or **[Clear/Stop]** key and enter the new number.

3 Enter the vertical size of the area with the number keys, then press the **[#]** key.

Note

- To change the number entered, press the **[Clear]** or **[Clear/Stop]** key and enter the new number.

5 Press the **[OK]** key.

6 Press the **[OK]** key.

7 Set your original, then press the **[Start]** key.

Margin Adjustment

You can shift the image left, right, top or bottom to make a binding margin.

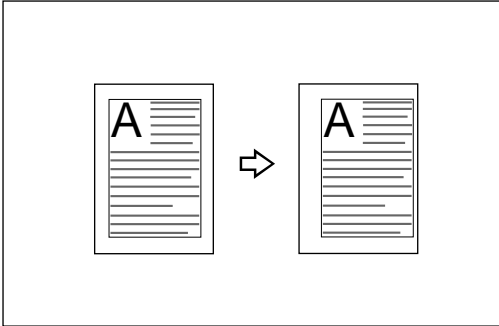

2

! Limitation

- If you set the margin too wide, areas you do not want to delete might be erased.

✎ Note

- You can change the width of the binding margin as follows:

Metric version	0 – 30mm (in 1mm steps)
Inch version	0" – 1.2" (in 0.1" steps)

- The margin width default is as follows. You can change this default setting with the User Tools. See “Front Margin: Left/Right”, “Back Margin: Left/Right”, “Front Margin: Top/Bottom”, “Back Margin: Top/Bottom” in ⇒ P.317 “Page Format 1/2”.

Metric version	<ul style="list-style-type: none"> • Front: 5mm Left • Back: 5mm Right
Inch version	<ul style="list-style-type: none"> • Front: 0.2" Left • Back: 0.2" Right

- When making two-sided copies from one-sided originals, you can set a binding margin for back pages. See “1 → 2 Duplex Auto Margin Adjust” in ⇒ P.317 “Page Format 1/2”.
- When making copies in Combine mode, the binding margins are made on the copies after the combining is finished.
- When “2 Sided → 1 Sided” is selected, set the binding margins for front and back pages of the original.

1 Press the [Edit/Stamp] key.

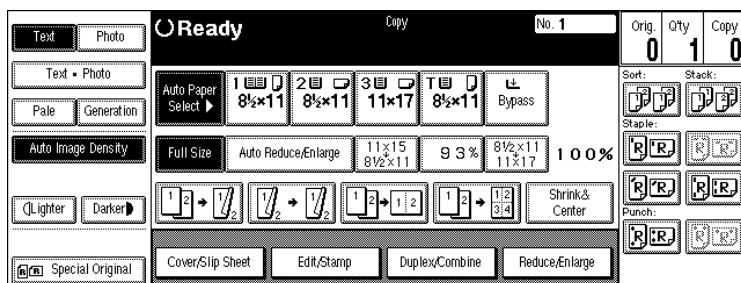

2 Press the [Margin Adj.] key.

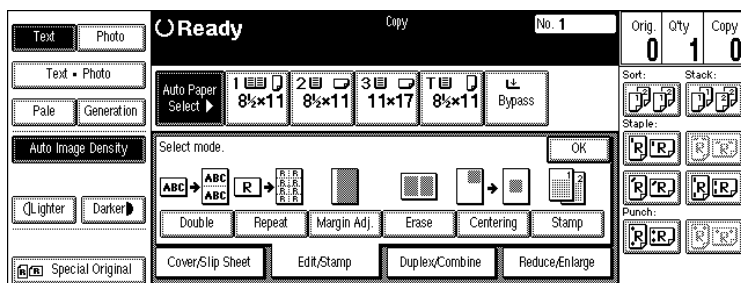

3 Set a binding margin for a front page. Press the [←] and [→] keys when setting the left and right margins, and the [↓] and [↑] keys when setting the top and bottom margins.

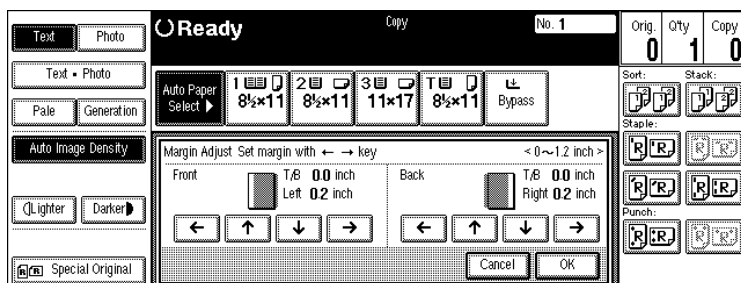

Note

- To change the value entered, press the [←], [→], [↓], [↑] keys and enter the new value.

4 Set a binding margin for back pages. Press the [←] and [→] keys when setting the left and right margins, and the [↓] and [↑] keys when setting the top and bottom margins.

Note

- You can specify the back margin only when the Duplex or the Two Sided copy with Combine is selected.
- If you do not need to specify the back margin, press the [OK] key and go to step 5.

5 Set your originals, then press the [Start] key.

2

Erase

This function erases the center and/or all four sides of the original image. This is useful for avoiding shadows on the copy image caused by the bound originals, such as books.

This function can be used in three ways:

❖ Border

This mode erases the edge margin of the original image.

❖ Center

This mode erases the center margin of the original image.

❖ Center/Border

This mode erases both the center and edge margins of the original image.

📌 Note

- You can change the width of the erased margin as follows:

Metric version	3 – 50mm (in 1mm steps)
Inch version	0.1" – 2.0" (in 0.1" steps)

- The default setting of the erased margin is as follows. You can change this settings with the User Tools. See “Erase Border” and “Erase Center” in ⇒ P.317 “Page Format 1/2”.

Metric version	10mm
Inch version	0.4"













- The width of the erased margin varies depending on the reproduction ratio.
- If the size of the original is different from sizes listed in the following chart, the erased margin might be shifted.

❖ Metric version

Where Original Is Set	Paper Size and Orientation
Exposure glass	A3☐, B4☐, A4☐☐, B5☐☐, 8 ¹ / ₂ " × 13"☐ ^{*1}
Document feeder	A3☐, B4☐, A4☐☐, B5☐☐, A5☐☐, B6☐☐, 11" × 17"☐, 11" × 15"☐, 8 ² / ₁ " × 11"☐☐, 8 ¹ / ₂ " × 13"☐ ^{*1}



^{*1} You can select from 8¹/₂" × 13", 8¹/₄" × 13" and 8" × 13" with the User Tools (System Settings). See “<F/F4>Size Setting” in the System Settings manual.

❖ Inch version

Where Original Is Set	Paper Size and Orientation
Exposure glass	11" × 17"  , 8 1/2" × 14"  , 8 1/2" × 11"  
Document feeder	A4  , 11" × 17"  , 11" × 15"  , 8 1/2" × 14"  , 8 1/2" × 11"   , 5 1/2" × 8 1/2"   , 8 1/2" × 13"  *1

*1 You can select from 8 1/2" × 13", 8 1/4" × 13" and 8" × 13" with the User Tools (System Settings). See "<F/F4>Size Setting" in the System Settings manual.

- The relationship between the original orientation and the erased part is as follows:

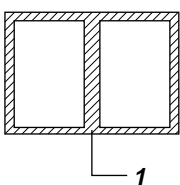
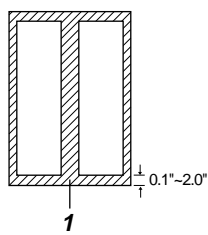
 original	 original
	

- 1: Erased part

Border Erase

This function erases the edge margins. You can set the same margin width for all four sides, or you can set different margin widths for each side.

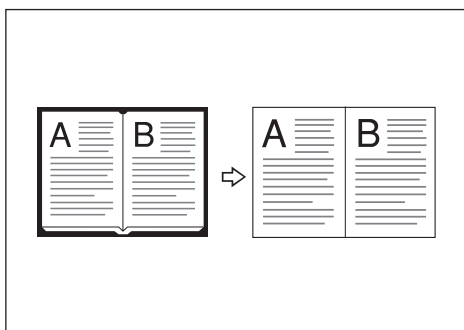

GCENT2E

Note

- If you want to erase the center margin too, use the Center/Border function. See ⇒ P.177 "Center/Border Erase".

1 Press the [Edit/Stamp] key.

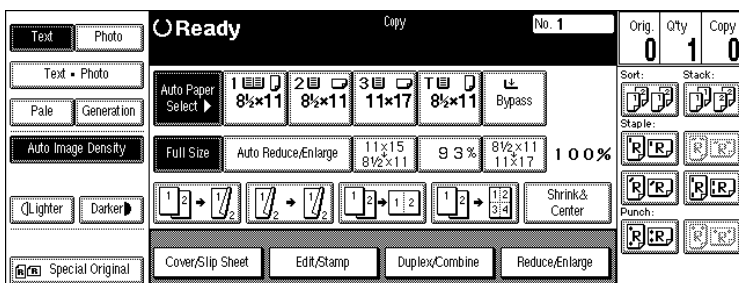

2 Press the [Erase] key.

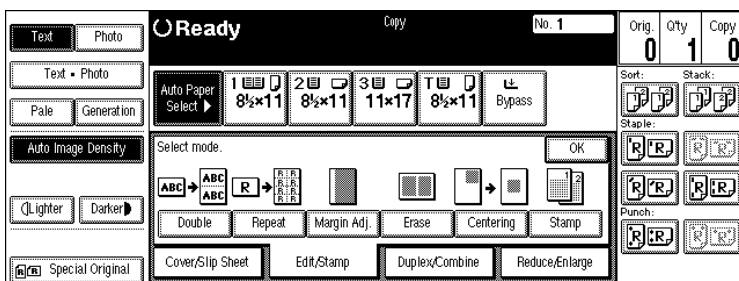

3 Press the [Border] key.

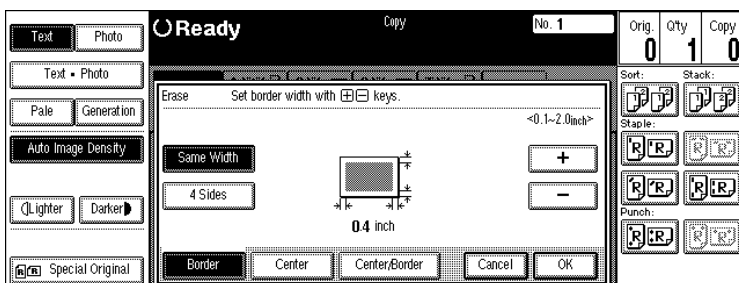

4 Set the erase border width.

Selecting [Same Width]

1 Press the [Same Width] key.

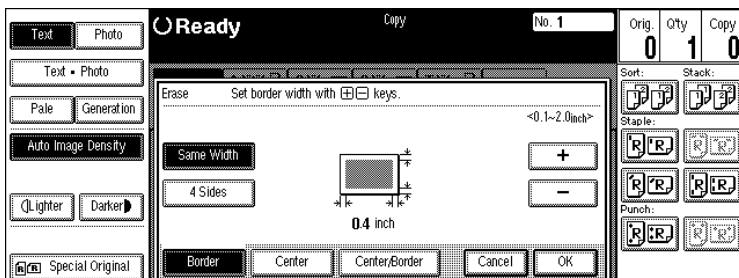

- Set an erase border width with the **[+]** and **[-]** keys, followed by the **[OK]** key.

 **Note**

- To change the value entered, press the **[+]** and **[-]** keys and enter the new value.

Selecting [4 Sides]

- Press the **[4 Sides]** key.

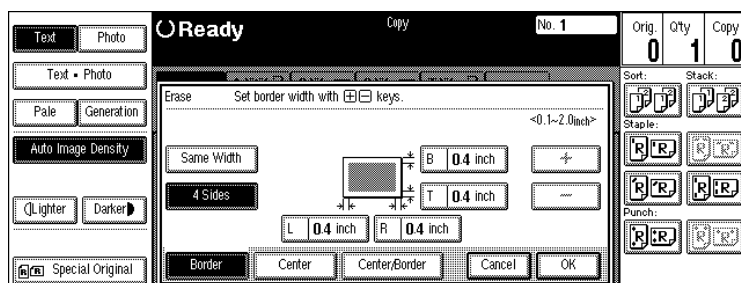

- Press the key for the border you wish to change and set an erase border width with the **[+]** and **[-]** keys.

 **Note**

- To change the value entered, press the **[+]** and **[-]** keys and enter the new value.

- Press the **[OK]** key.

- Set your originals, then press the **[Start]** key.

Center Erase

This function erases the center margin.

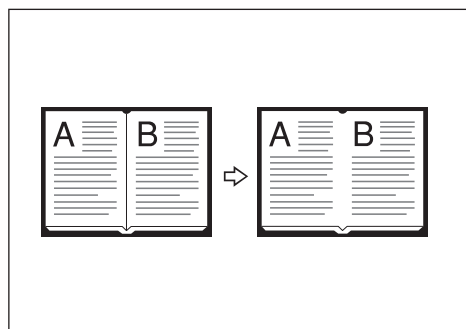

GCCENT1E

 **Note**

- If you want to erase the border margin too, use the Center/Border function. See ⇒ P.177 "Center/Border Erase".

1 Press the [Edit/Stamp] key.

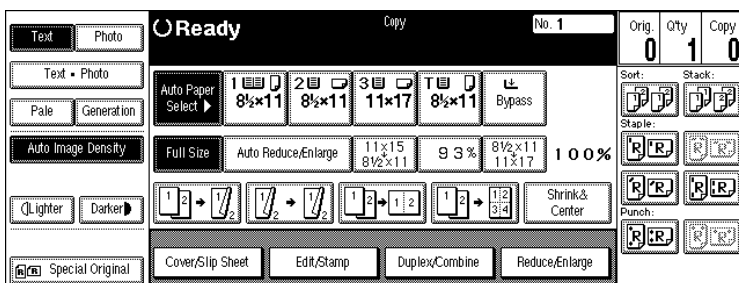

2 Press the [Erase] key.

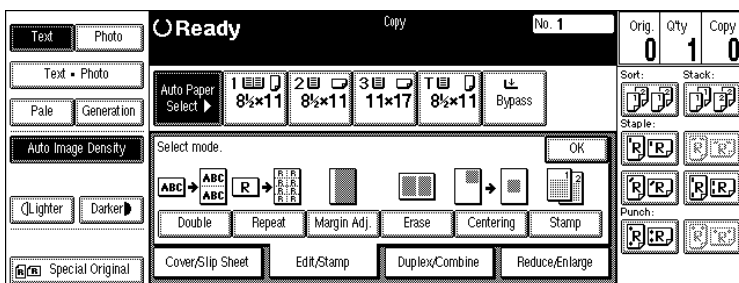

3 Press the [Center] key.

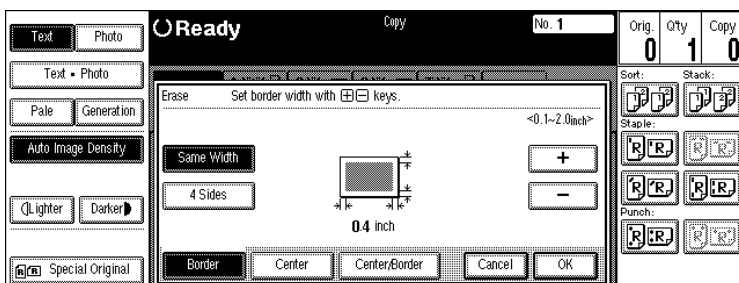

4 Set the erase center width with the [+] and [-] keys. Then press the [OK] key.

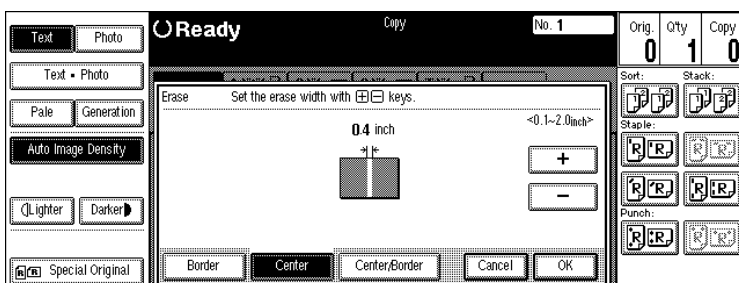

Note

- To change the value entered, press the [+] and [-] keys and enter the new value.

5 Set your originals, then press the [Start] key.

Center/Border Erase

This mode erases both the center and edge margins. You can set the same margin width for all four sides and center, or you can set different margin widths for each.

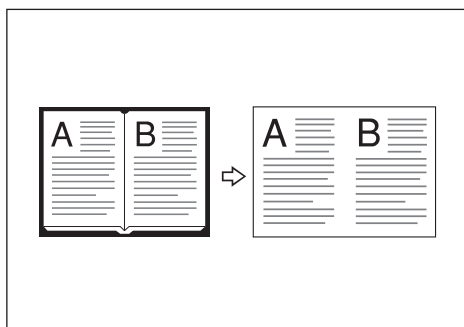

GCCENT3E

1 Press the [Edit/Stamp] key.

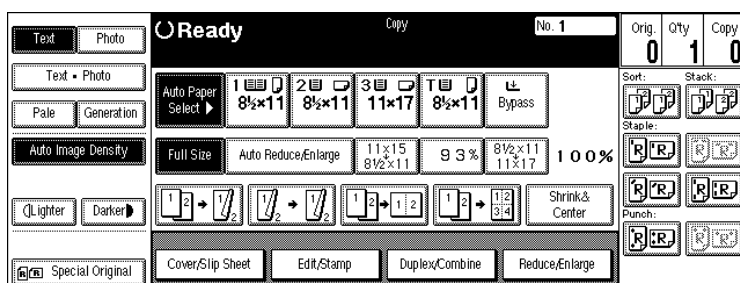

2 Press the [Erase] key.

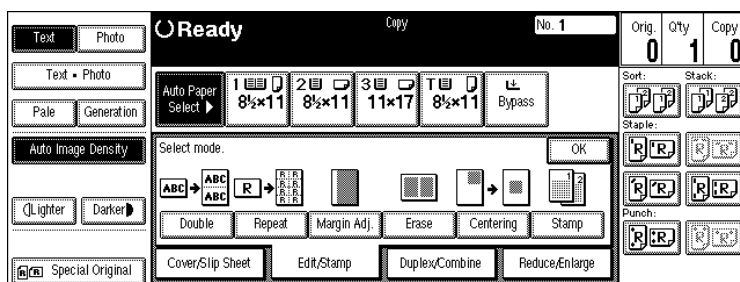

3 Press the [Center/Border] key.

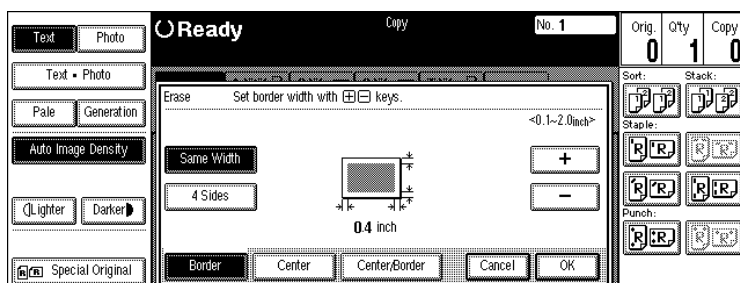

4 Set the erase margin width.

Selecting [Same Width]

- 1 Press the [Center] key, then set the erase center width with the [+] and [-] keys.

Note

- To change the value entered, press the [+] and [-] keys and enter the new value.

- 2 Press the [Same Width] key.

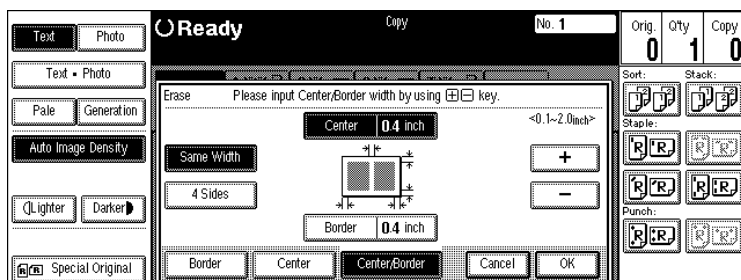

- 3 Press the [Border] key, then set the erase border width with the [+] and [-] keys.

Note

- To change the value entered, press the [+] and [-] keys and enter the new value.

- 4 Press the [OK] key.

Selecting [4 Sides]

- 1 Press the [4 Sides] key.

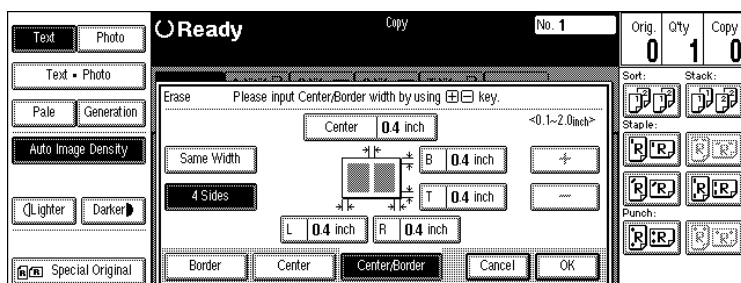

- 2 Press the key for the part you wish to change and set an erase margin width with the [+] and [-] keys.

Note

- To change the value entered, press the [+] and [-] keys and enter the new value.

- 3 Press the [OK] key.

- 5 Set your originals, then press the [Start] key.

Centering

You can make copies by moving the image to the center of the copy paper.

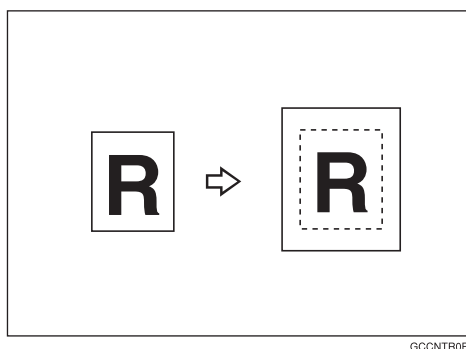

GCCNTRFE

⚠ Limitation

- You cannot use the bypass tray with this function.
- If the direction of originals is different from that of the copy paper, the machine will not rotate the image by 90° (rotated copy).
- If the original size cannot be measured, the centering function will not work.

📝 Note

- The original sizes and directions for centering are listed below.

❖ Metric version

Original placed on:	Original size and direction
Exposure glass	A3☐, B4☐, A4☐☐, B5☐☐, 8 ¹ / ₂ " × 13"☐ ^{*1} , 8K☐, 16K☐☐
Document feeder	A3☐, B4☐, A4☐☐, B5☐☐, A5☐☐, B6☐☐, 11" × 17"☐, 11" × 15"☐, 8 ¹ / ₂ " × 11"☐☐, 8 ¹ / ₂ " × 13"☐ ^{*1}

^{*1} You can select from 8¹/₂" × 13", 8¹/₄" × 13" and 8" × 13" with the User Tools (System Settings). See "<F/F4>Size Setting" in the System Settings manual.

❖ Inch version

Original placed on:	Original size and direction
Exposure glass	11" × 17"☐, 8 ¹ / ₂ " × 14"☐, 8 ¹ / ₂ " × 11"☐☐
Document feeder	A4☐☐, 11" × 17"☐, 11" × 15"☐, 8 ¹ / ₂ " × 14"☐, 8 ¹ / ₂ " × 11"☐☐, 5 ¹ / ₂ " × 8 ¹ / ₂ "☐☐, 8 ¹ / ₂ " × 13"☐ ^{*1}

^{*1} You can select from 8¹/₂" × 13", 8¹/₄" × 13" and 8" × 13" with the User Tools (System Settings). See "<F/F4>Size Setting" in the System Settings manual.

1 Select the paper.

2 Press the [Edit/Stamp] key.

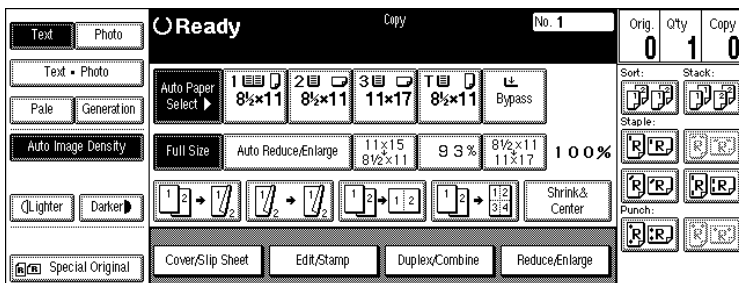

3 Press the [Centering] key.

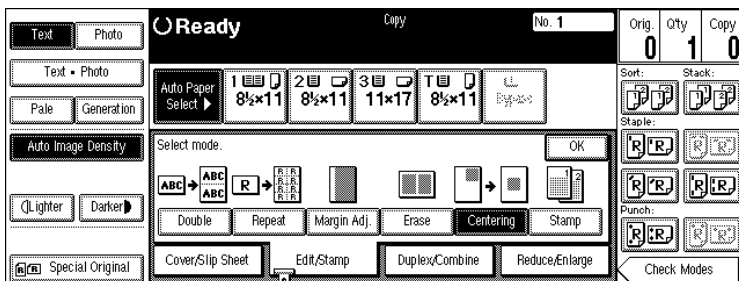

4 Press the [OK] key.

5 Set your originals, then press the [Start] key.

Stamp

This function prints stamp on the copies. Stamp modes are as follows:

❖ Background Numbering

This function prints numbers on the background of copies.

❖ Preset Stamp

This function prints preset messages on copies.

❖ User Stamp

This function prints custom messages on copies.

❖ Date Stamp

This function prints the date on copies.

❖ Page Numbering

This function prints page numbers on copies.

Background Numbering

Use this function to have numbers printed on the background of copies.

This function can help you to keep track of confidential documents.

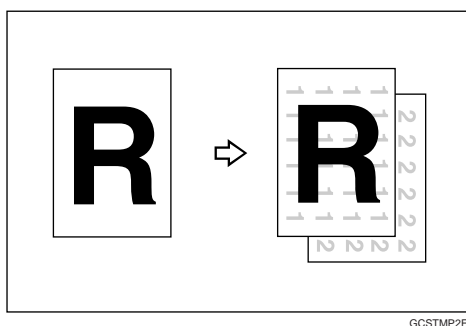

GCSTMP2E

💡 Limitation

- You cannot use the bypass tray with this function.

📝 Note

- You can change the size of the numbers with the User Tools. See “Size” in ⇒ P.323 “Background Numbering”.
- You can change the density of the numbers with the User Tools. See “Density” in ⇒ P.323 “Background Numbering”.
- Numbers are printed on all pages.
- You can select whether the Background Numbering is printed negative if it overlaps black parts of image. See “Superimpose” ⇒ P.323 “Background Numbering”.
- You can change the starting number of the Background Numbering (1 – 999).

1 Press the [Edit/Stamp] key.

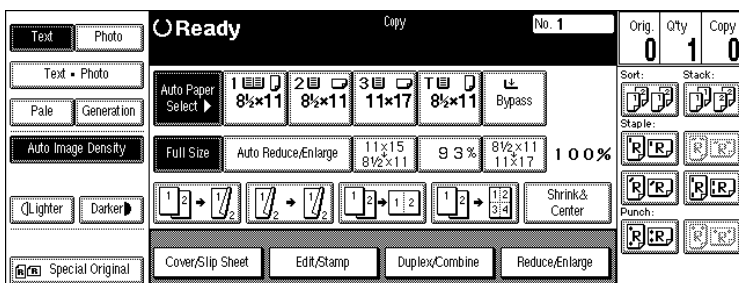

2

2 Press the [Stamp] key.

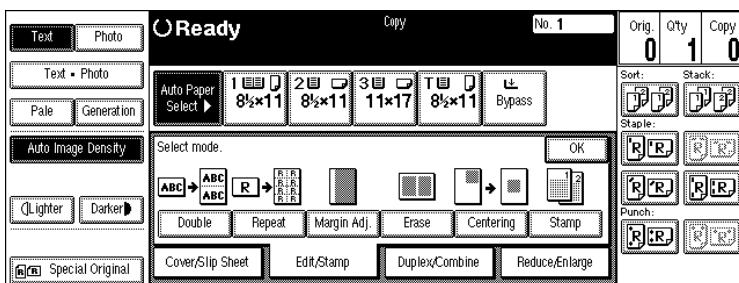

3 Press the [Background Numbering] key.

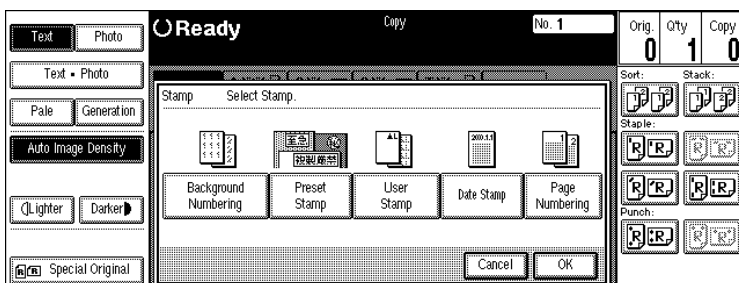

4 Enter the number to start counting from with the number keys. Then press the [OK] key.

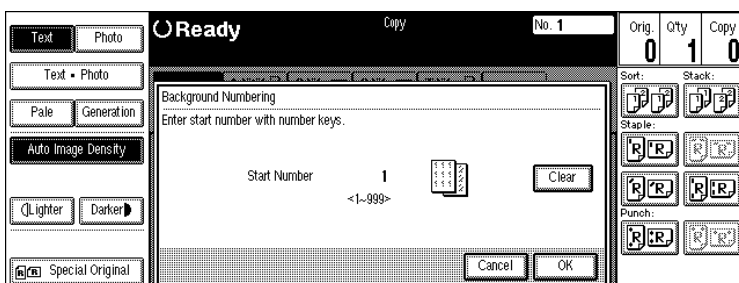

Note

- The number can be set from 1 to 999.
- To change the entered number, press the [Clear] or [Clear/Stop] key and enter the new number.

5 Press the [OK] key.

6 Set your originals, then press the [Start] key.

Preset Stamp

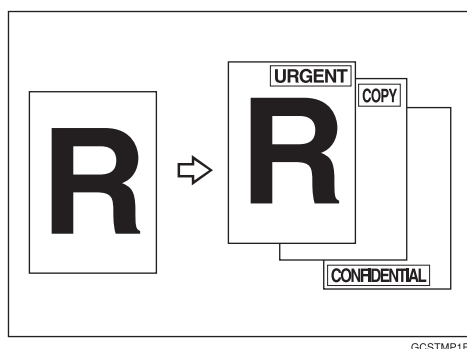

! Limitation

- You cannot use the bypass tray with this function.
- One message can be stamped at a time.

📝 Note

- One of the following eight messages can be stamped on copies with a frame around it: "COPY", "URGENT", "PRIORITY", "For Your Info.", "Preliminary", "For internal use", "CONFIDENTIAL", "DRAFT".
- You can change the print page with the User Tools.
- You can change the size and density of the stamp with the User Tools.
- Depending on the paper size, if you change the stamp size, parts of the stamp might not be printed.
- You can choose the default settings for the position, size and density of the stamp with the User Tools. See "Stamp position", "Stamp condition" in ⇒ P.323 "Preset Stamp".
- You can choose the default settings for the print page with the User Tools. See "Stamp condition" in ⇒ P.323 "Preset Stamp".
- You can change the stamp language with the User Tools. See "Stamp Language" in ⇒ P.323 "Preset Stamp".
- You can select whether the Preset Stamp is printed negative if it overlaps black parts of the image. See "Superimpose" in ⇒ P.323 "Preset Stamp".
- You cannot combine the Preset Stamp function with the Image Repeat or Double Copies function.
- When you combine this function with the Magazine or Booklet function, only the first page is stamped.

- The relationship between the direction in which you set the original and stamp orientation/position is as follows:

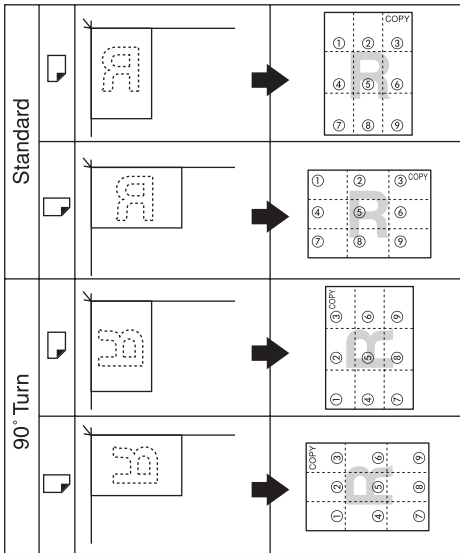

Key on the display									
Stamp position	①	②	③	④	⑤	⑥	⑦	⑧	⑨

GCSTMP5E

- You can change the stamp position to top, bottom, left and right each way in 1mm, 0.1" steps. See "Stamp position" in ⇒ P.323 "Preset Stamp".

1 Press the [Edit/Stamp] key.

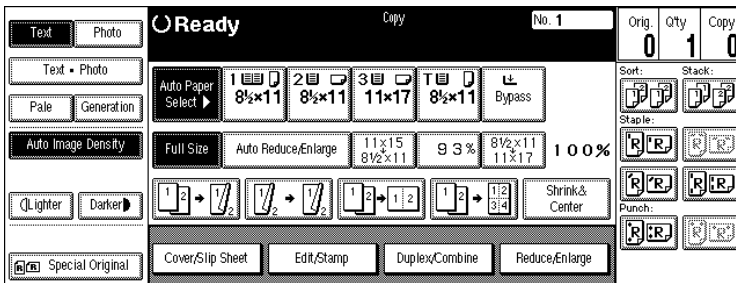

2 Press the [Stamp] key.

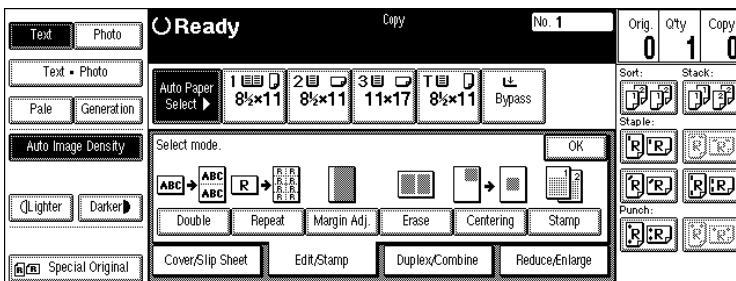

3 Press the [Preset Stamp] key.

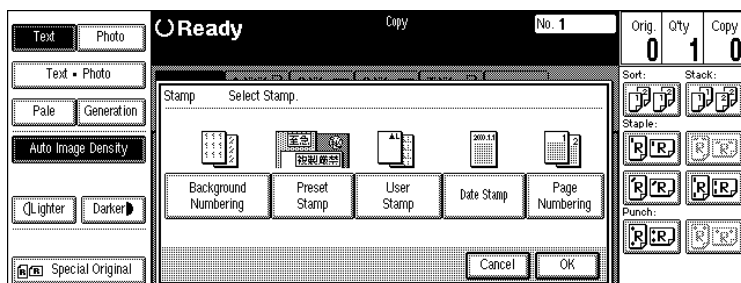

4 Select the desired message.

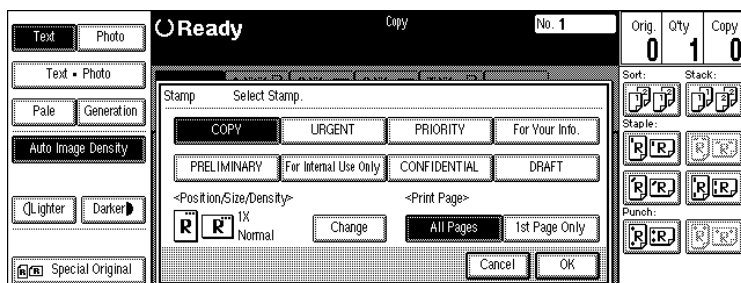

5 Press the [All Pages] or [1st Page Only] key to select the print page.

⚠ Limitation

- If you combine this function with the Magazine or Booklet function, "1st Page Only" is selected automatically.

6 Change the stamp position, size or density.

If you do not wish to change, go to step 7.

To change the stamp position, size or density

1 Press the [Change] key.

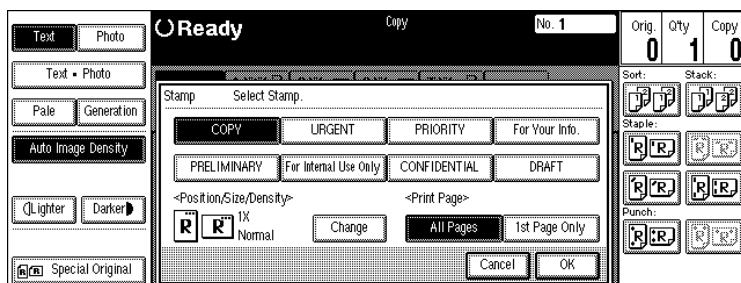

2 Select the desired position, size and density.

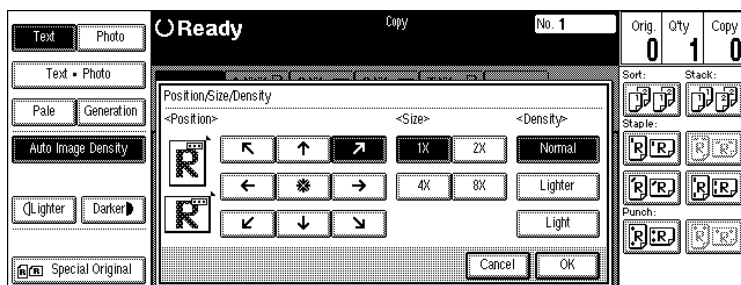

3 Press the [OK] key.

7 After you specified all the desired settings, press the [OK] key.

8 Press the [OK] key.

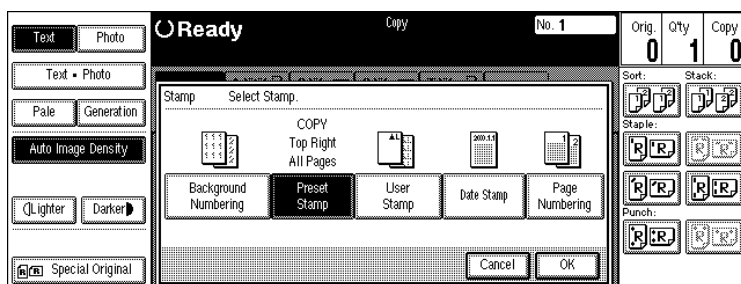

Note

To cancel the settings, press the [Cancel] key.

9 Set your originals, then press the [Start] key.

User Stamp

Up to four messages which you use frequently can be stored in the machine's memory and stamped on copies.

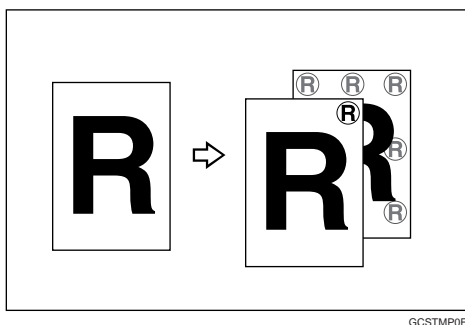

Preparation

Before using this function, you have to store your messages with the User Tools. See ⇒ P.189 "Program/Delete User Stamp".

⚠ Limitation

- You cannot use the bypass tray with this function.
- One message can be stamped at a time.
- In Connect Copy mode, register the same user stamp on the master unit and sub-unit.
- If the position exceeds the page boundary, the stamp will not be printed on copies.

📝 Note

- You can change the print page with the User Tools.
- You can choose the default settings for the print page and the stamp position with the User Tools. See “Stamp condition” and “Stamp position” in ⇒ P.325 “User Stamp”.
- You can combine this function with only one Preset Stamp.
- You cannot combine the User Stamp function with the Image Repeat or Double Copies function.
- The relationship between the direction in which you set the original and stamp Orientation/Position is as follows:

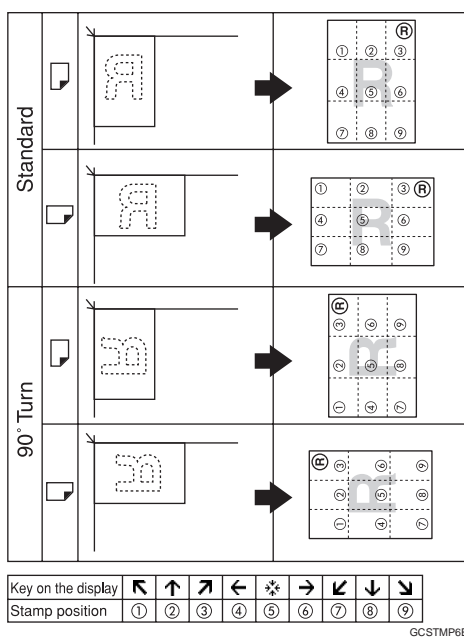

- You can change the stamp position to top, bottom, left and right each way in 1mm, 0.1" steps. See “Stamp position” in ⇒ P.325 “User Stamp”.

1 Press the [Edit/Stamp] key.

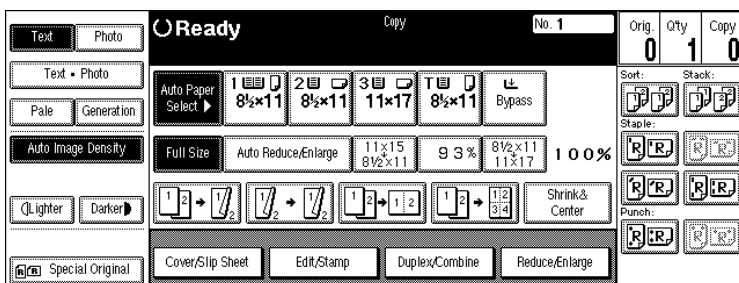

2 Press the [Stamp] key.

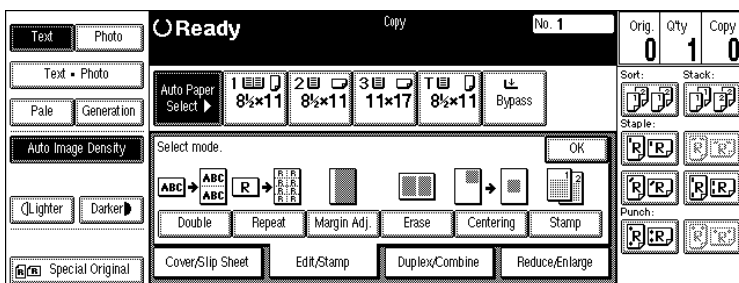

3 Press the [User Stamp] key.

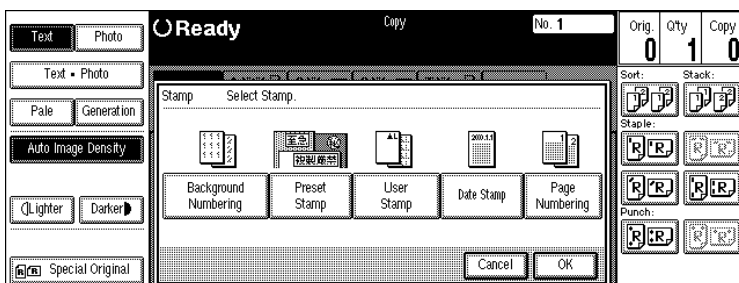

4 Select the stamp you require.

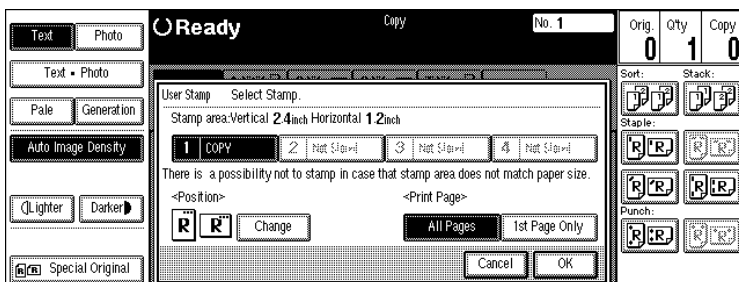

5 Press the [All Pages] or [1st Page Only] key to select the print page.

2

To change the stamp position

- 1 Press the [Change] key.
- 2 Select the desired position.

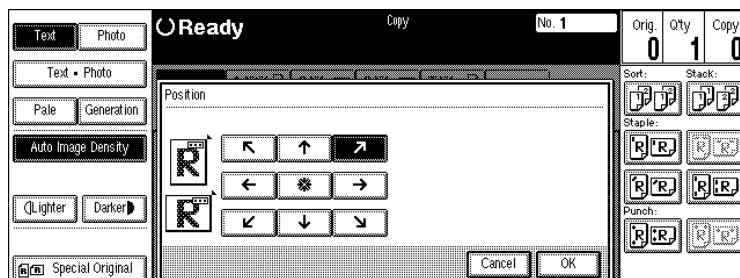

- 3 Press the [OK] key.
- 6 After you specified all the desired settings, press the [OK] key.

Note

- To cancel the settings, press the [Cancel] key.

- 7 Press the [OK] key.

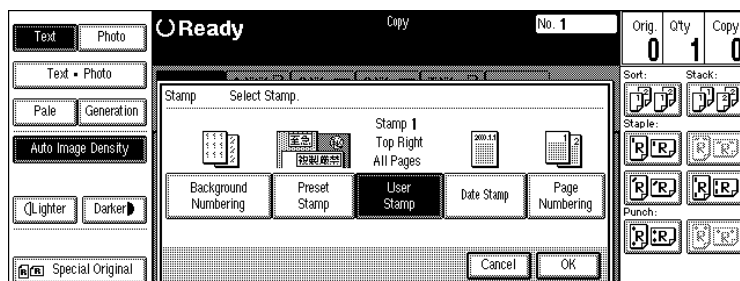

- 8 Set your originals, then press the [Start] key.

Program/Delete User Stamp

- 1 Make sure that the machine is in Copy mode.
- 2 Press the [User Tools/Counter] key.

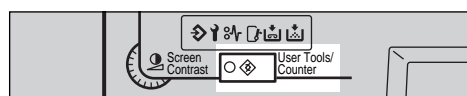

TSPS040N

3 Press the [Copy/Document Server Features] key.

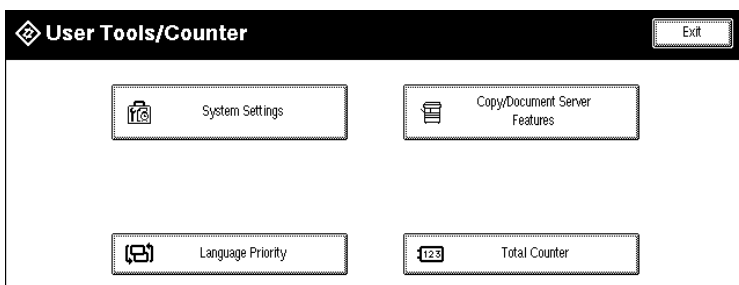

4 Press the [Stamp Setting] key.

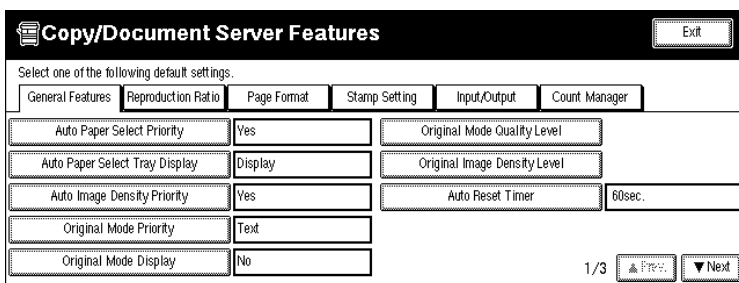

5 Press the [User Stamp] key.

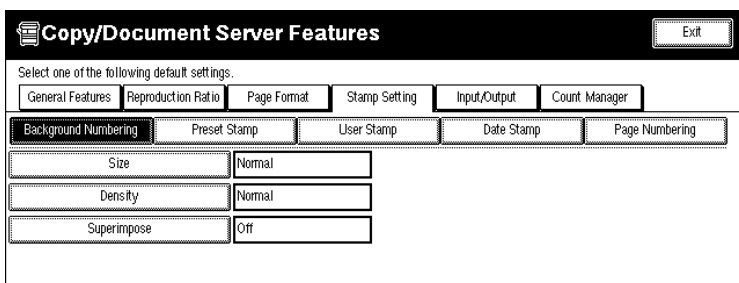

6 Press the [Program/Delete Stamp] key.

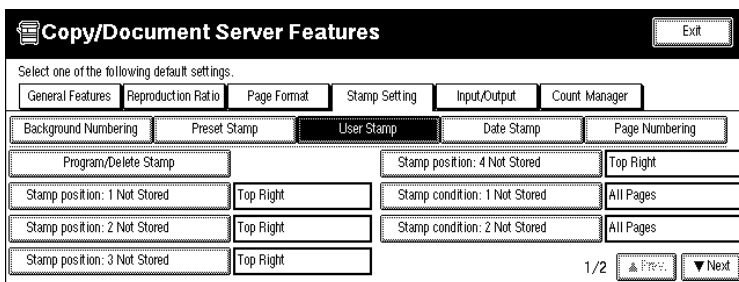

To program the User Stamp

- 1 Press the **[Program]** key.

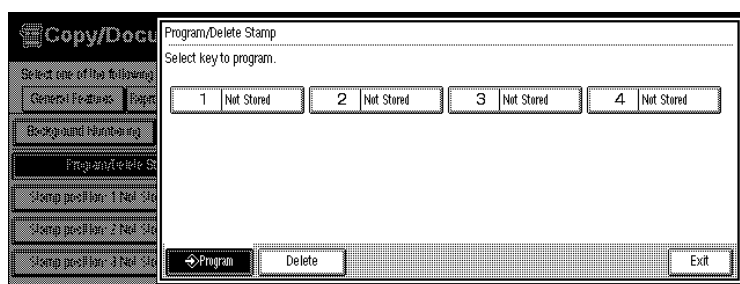

- 2 Press the stamp number (1 – 4) you want to program.

Note

- Stamp numbers with  already have settings in them.
- If the stamp number is already being used, the machine will ask you if you wish to overwrite it — Press the **[Yes]** or **[No]** key.

- 3 Enter the user stamp name with the letter keys on the display panel.

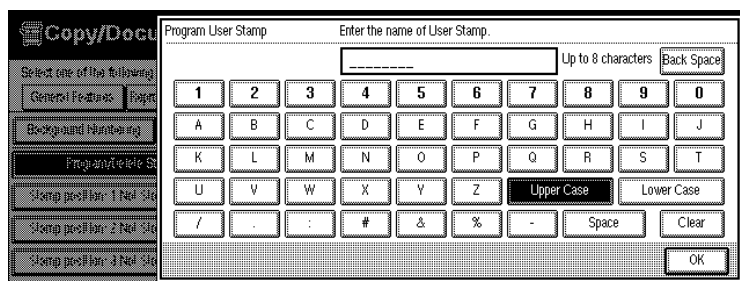

Note

- You can register up to 8 characters.
- To change the name entered, press the **[Back Space]**, **[Clear]** or **[Clear/Stop]** key and enter new letters.

- 4 Press the **[OK]** key.

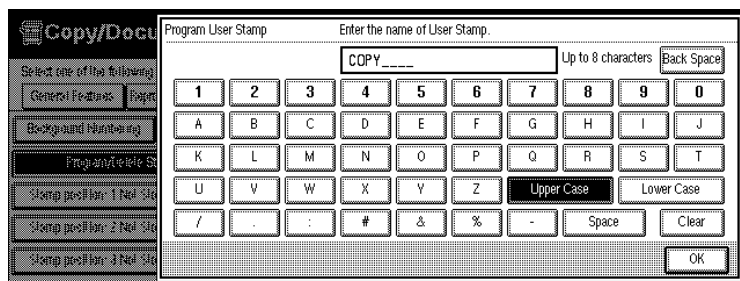

- 5 Enter the horizontal size of the stamp with the number keys, then press the [#] key.

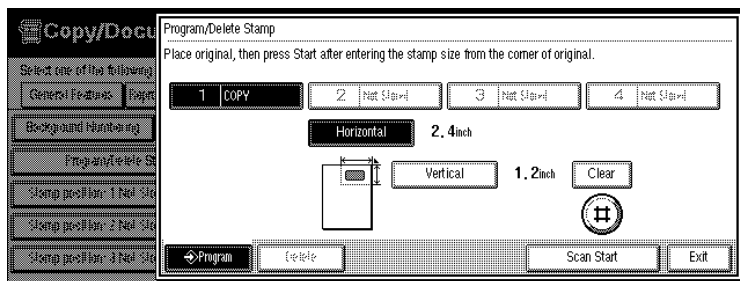

Note

- To change the value entered, press the **[Clear]** or **[Clear/Stop]** key and enter the new value.
 - You can enter sizes within 10 – 432mm, 1.0" – 17.0" horizontal, and 10 – 297mm, 1.0" – 11.7" vertical. However, if the value exceeds the maximum value of the area (5,000mm², 7.75 inch²), it is corrected within the range of the area automatically.
- 6 Press the **[Vertical]** key, and enter the vertical size in the same way as step 5.
- 7 Set the user stamp on the exposure glass, and then press the **[Scan Start]** key.

Note

- Do not set the original in the document feeder.
 - The machine scans the original three times. Do not lift the document feeder until the main menu of the Copy features appears.
 - If you press the **[Exit]** key, the main menu of the Copy features appears with nothing programmed.
- 8 Press the **[Exit]** key.

To delete the User Stamp

Important

You cannot restore a deleted stamp.

1 Press the **[Delete]** key.

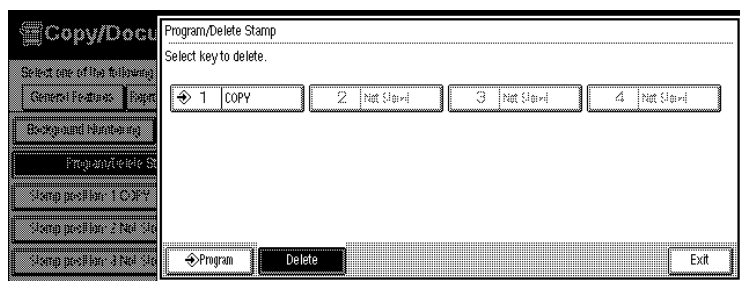

2 Press the stamp number (1 – 4) you want to delete.

Note

Only programs with  contain a user stamp.

3 Press the **[Delete]** key.

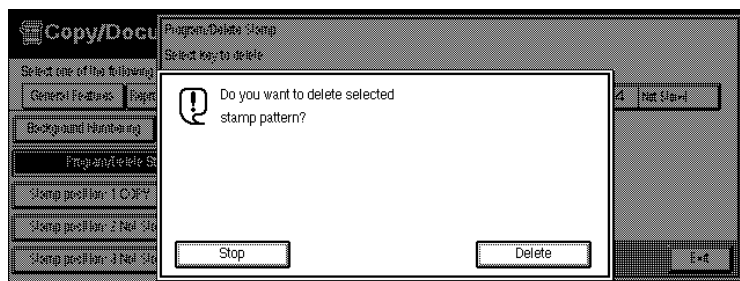

Note

To cancel the deletion, press the **[Stop]** key.

4 Press the **[Exit]** key.

5 Press the **[Exit]** key.

7 Press the **[Exit]** key.

The initial display appears.

Date Stamp

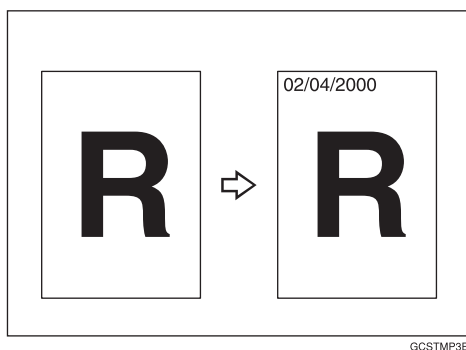

! Limitation

- You cannot use the bypass tray with this function.

✎ Note

- You can select the following styles:
 - MM/DD/YYYY
 - MM.DD.YYYY
 - DD/MM/YYYY
 - DD.MM.YYYY
 - YYYY.MM.DD
 - DD.JUN.YYYY
- You can change the Date Stamp settings with the User Tools. See ⇒ P.325 "Date Stamp".
- The font and size of the Date Stamp can be changed with the User Tools. See "Font" and "Size" in ⇒ P.325 "Date Stamp".
- You can select whether the Date Stamp is printed negative if it overlaps black parts of an image. See "Superimpose" in ⇒ P.325 "Date Stamp".
- For how to set the date, see "Set Date" in the System Settings manual.
- You can choose the default settings for the stamp position with the User Tools. See "Position Priority" in ⇒ P.325 "Date Stamp".
- The size, font and superimpose settings are linked with the Page Numbering functions.
- You cannot combine the Date Stamp function with the Image Repeat or Double Copies function.

- The relationship between the direction in which you set the original and the stamp position is as follows:

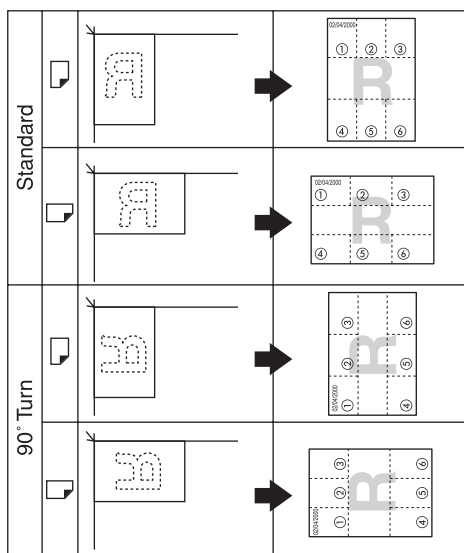

Key on the display	↶	↷	↘	↙	↵	↶
Stamp position	①	②	③	④	⑤	⑥

GCSTMP7E

- You can change the stamp position to top, bottom, left and right each way in 1mm, 0.1" steps. See "Position Priority" in ⇒ P.325 "Date Stamp".
- If you combine this function with the Combine, Magazine or Booklet function, the page is stamped as follows.
 - Combined with the Combine function

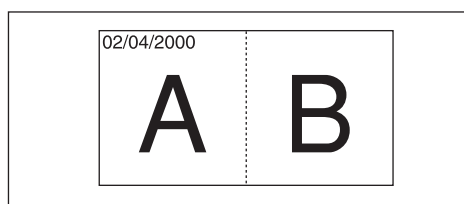

GCSTMPAE

- Combined with the Magazine or Booklet function

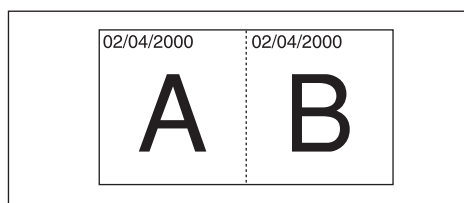

GCSTMP9E

1 Press the [Edit/Stamp] key.

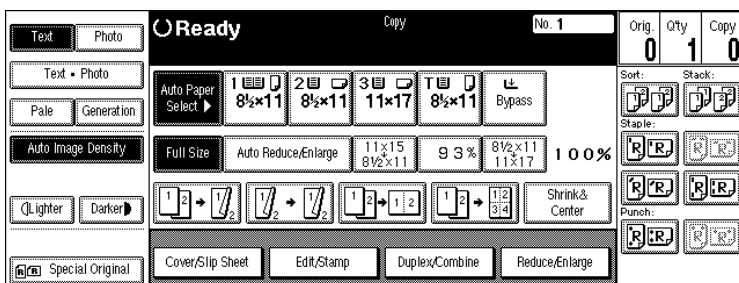

2 Press the [Stamp] key.

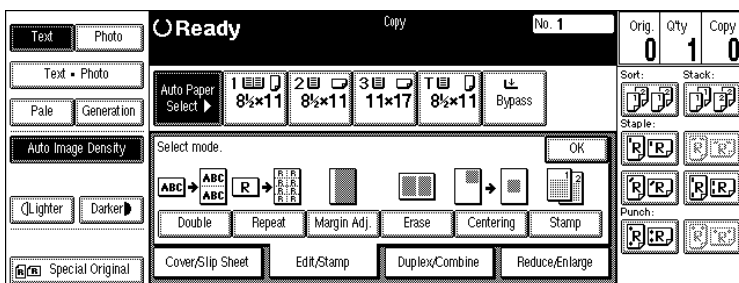

3 Press the [Date Stamp] key.

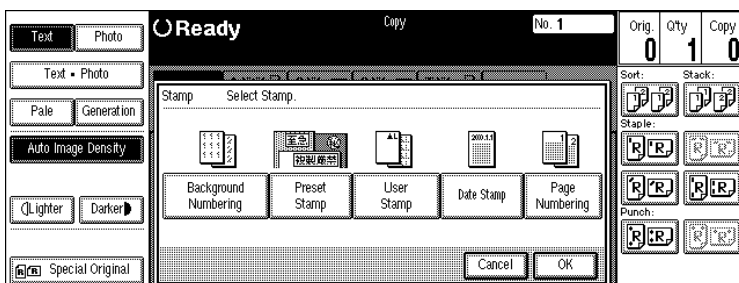

4 Press the [All Pages] or [1st Page Only] to select the print page.

To change the style of date

1 Press the [Change style] key.

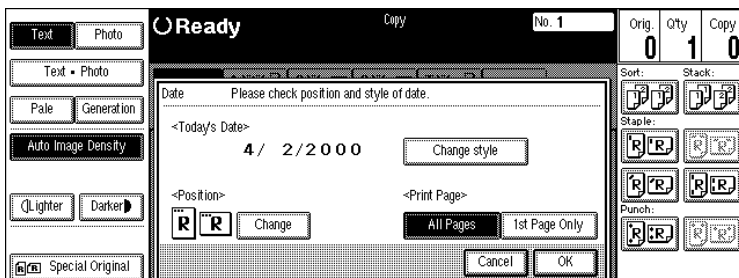

2 Select the style of date.

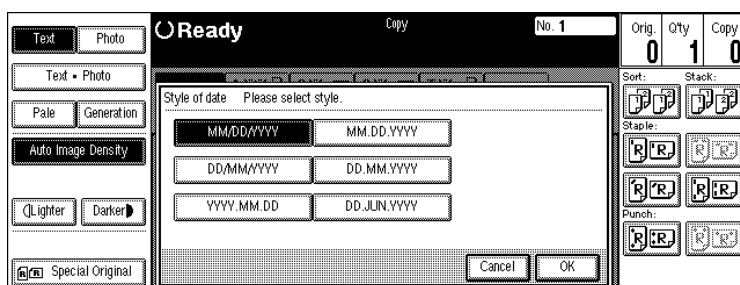

3 Press the [OK] key.

To change the stamp position

1 Press the [Change] key.

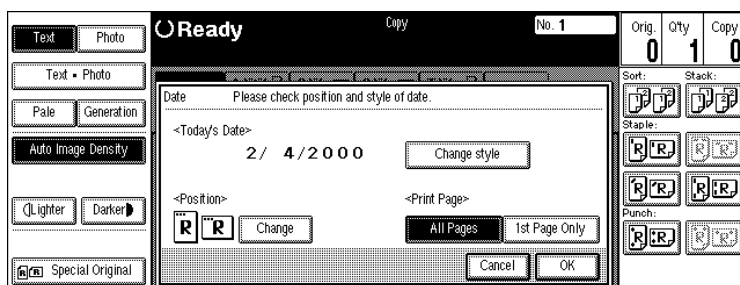

2 Select the desired position of the Date Stamp.

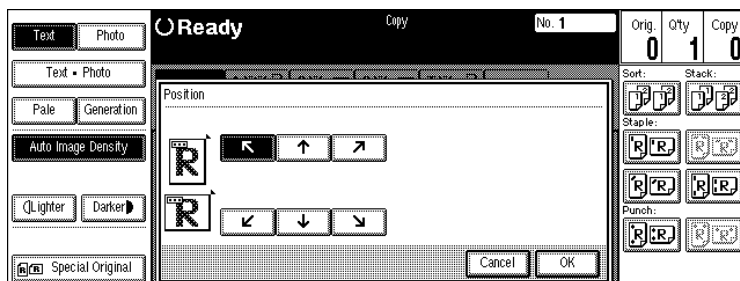

3 Press the [OK] key.

5 After you specified all the desired settings, press the [OK] key.

Note

- To cancel the settings, press the [Cancel] key.

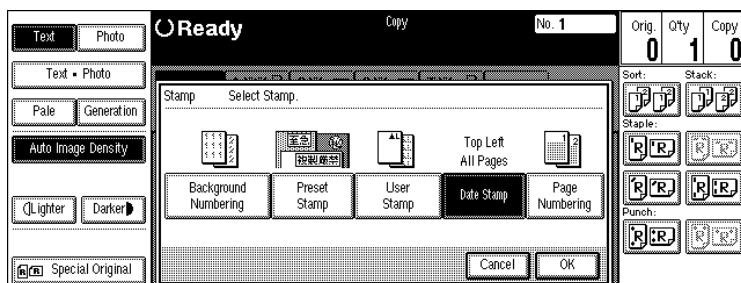
6 Press the [OK] key.**7** Set your originals, then press the [Start] key.

Page Numbering

Use this function to print page numbers on your copies. There are six types of Page Numbering (n is the total number of pages in your original):

- Type A: P1,P2,...Pn
- Type B: 1/n,2/n,...n/n
- Type C: -1-,-2-,...-n-
- Type D: P.1,P.2,...P.n
- Type E: 1, 2...n
- Type F: 1-1,1-2,..1-n

⚠ Limitation

- You cannot use the bypass tray with this function.

📝 Note

- You can change the Page Numbering settings with the User Tools. See ⇒ P.326 "Page Numbering".
- The font and size of Page Numbering can be changed with the User Tools. See "Font" and "Size" in ⇒ P.326 "Page Numbering".
- You can select whether the Page Numbering is printed negative if it overlaps black parts of image. See "Superimpose" in ⇒ P.326 "Page Numbering".
- You can choose the default settings for the stamp position with the User Tools. See "Position Priority" in ⇒ P.326 "Page Numbering".
- You can choose the default settings for the stamp format with the User Tools. See "Format Priority" in ⇒ P.326 "Page Numbering".
- The font, size and superimpose settings are linked with the Date Stamp function.
- You cannot combine the Page Numbering function with the Image Repeat or Double Copies function.

- ❑ The relationship between the direction in which you set the original and the Page Numbering orientation/position is as follows:

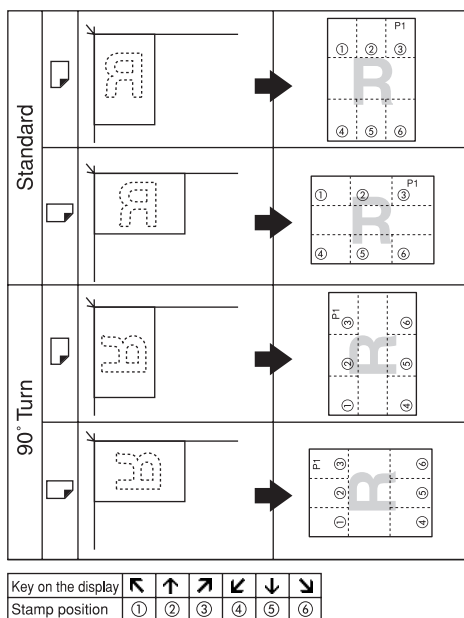

- ❑ You can change the stamp position to top, bottom, left and right each way in 1mm, 0.1" steps. See "Position Priority" in ⇒ P.326 "Page Numbering".
- ❑ If you combine this function with the Duplex (Top to Top) function and select the "P1, P2" or "1/n, 2/n" style, the page numbers on the back of the copy paper are printed as follows.

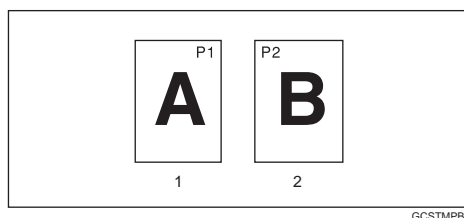

1. Front

2. Back

- ❑ If you combine this function with the Duplex (Top to Top) function, you can change the setting to stamp on the back side in the same position as the front side. See "Duplex Back Page Number Position" in ⇒ P.326 "Page Numbering".
- ❑ If you use this function with the Combine, Magazine, or Booklet function, the page is stamped as follows.

❖ **Page Numbering per original**

- Combined with 1 Sided/2 Sided in the Combine function

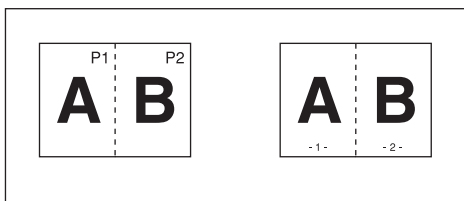

GCANPE0E

- Combined with the Magazine or Booklet function

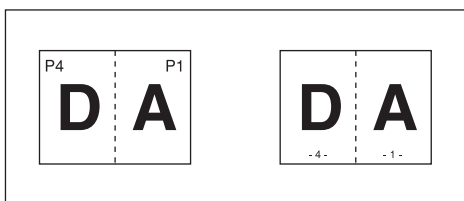

GCANPE1E

❖ **Page Numbering per copy**

- Combined with 1 Sided/2 Sided in the Combine function

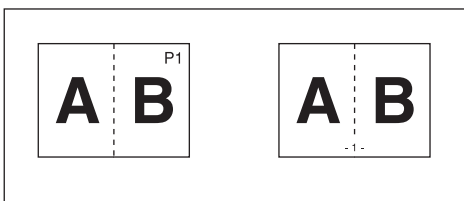

GCANPE2E

- ❑ See “Page Numbering In Combine Mode” in ⇒ P.326 “Page Numbering”.
- ❑ If you use the “1-1, 1-2” style, you can print page numbers on the slip sheets in Designate or Chapters mode. See “Copy On Slip Sheet In Designate Mode” in ⇒ P.326 “Page Numbering”.

1 Press the [Edit/Stamp] key.

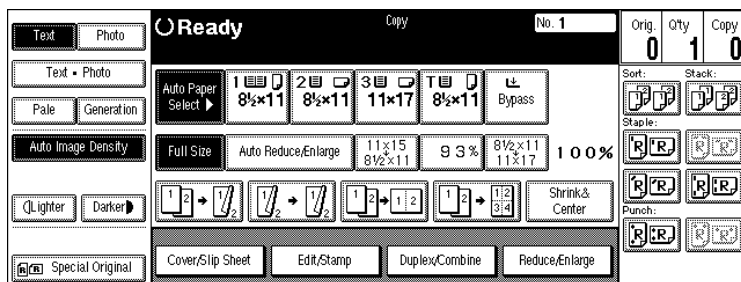

2 Press the [Stamp] key.

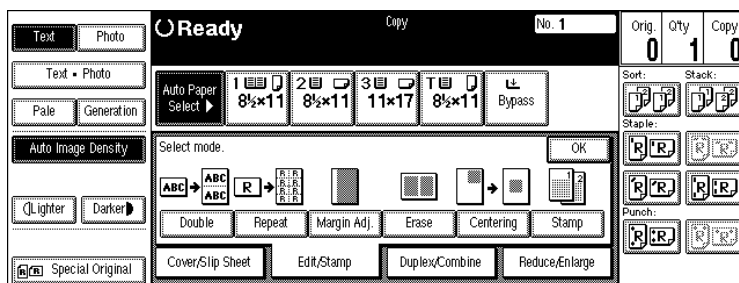

3 Press the [Page Numbering] key.

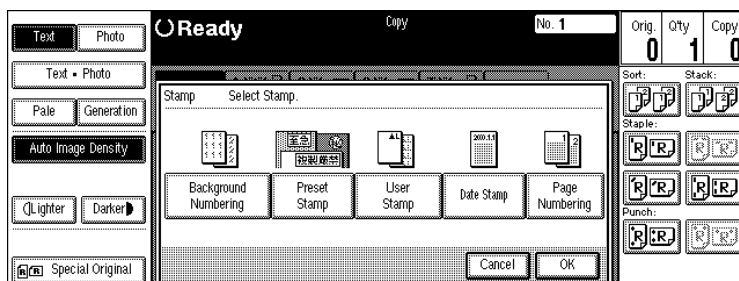

4 Select the style.

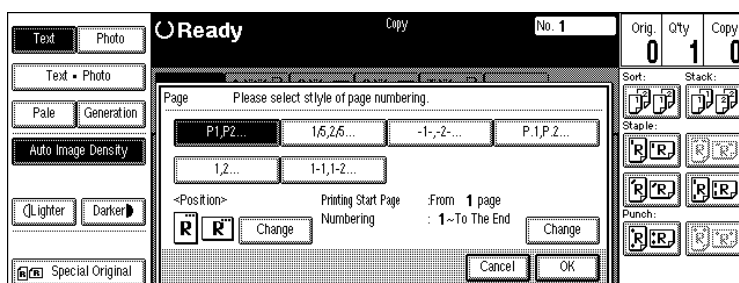

5 To change the stamp position, press the [Change] key.

If you do not wish to change the stamp position, go to step 7.

6 Select the stamp position, then press the [OK] key.

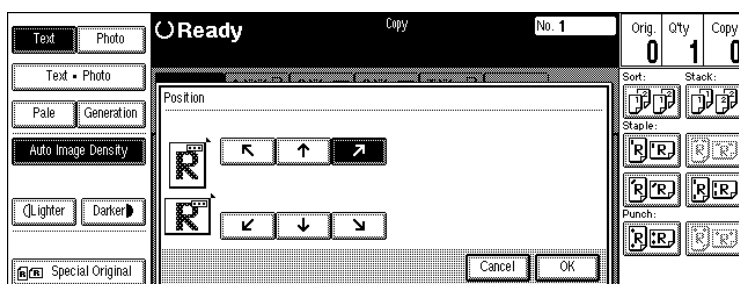

7 To change the first printing page and start number, press the [Change] key.

Note

- The display differs depending on the selected style.
- If you do not wish to change, press the **[OK]** key and set your originals, then press the **[Start]** key.

8 Specify the page and number.

If you selected (P1,P2..., -1,-,-2-..., P.1, P.2..., 1, 2...,)

- 1** Press the **[First Printing Page]** key, then enter the original sheet number from which to start numbering with the number keys.

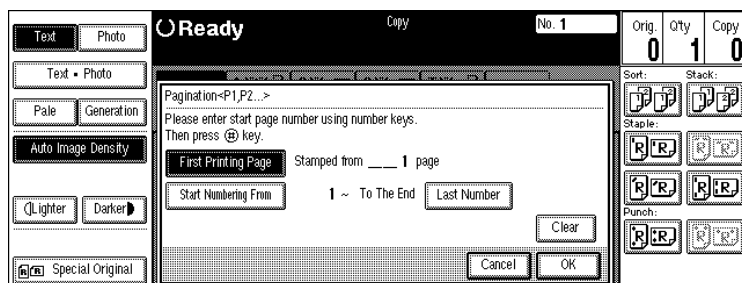
**Note**

- To change the number entered, press the **[Clear]** or **[Clear/Stop]** key and enter a new number.

- 2** Press the **[#]** key.
- 3** Press the **[Start Numbering From]** key, then enter the number from which to start numbering with the number keys.

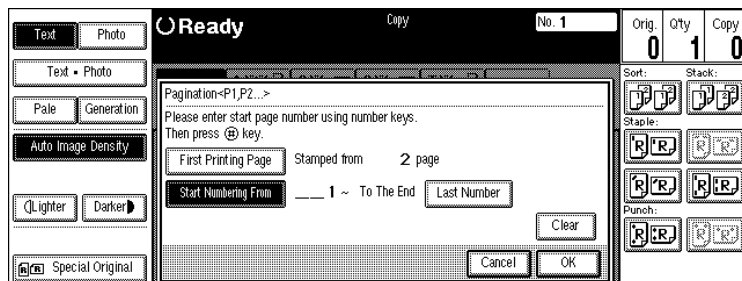

- 4** Press the **[#]** key.

- 5 Press the [Last Number] key, then enter the page number at which to stop numbering with the number keys.

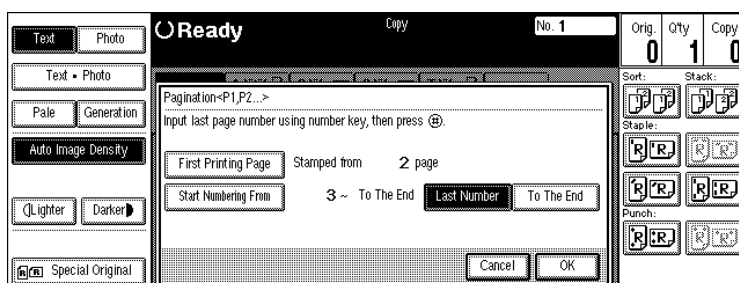

Note

- If you wish to print onto the last page, press the [To The End] key and go to step 10.

- 6 Press the [#] key.

If you selected (1/5,2/5...)

- 1 Press the [First Printing Page] key, then enter the original sheet number from which to start numbering with the number keys.

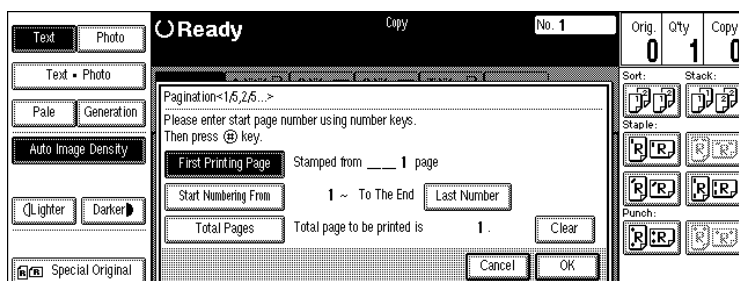

Note

- To change the number entered, press the [Clear] or [Clear/Stop] key and enter a new number.

- 2 Press the [#] key.

- 3 Press the [Start Numbering From] key, then enter the page number from which to start numbering with the number keys.

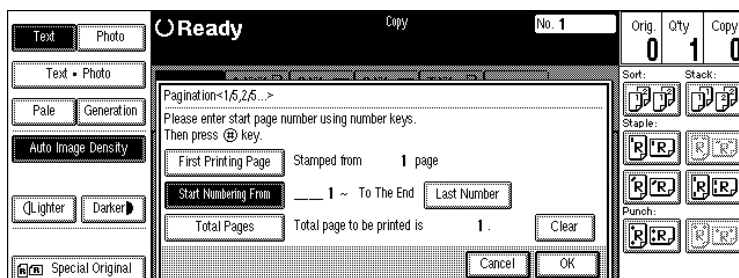

- 4 Press the [#] key.

- 5 Press the [Last Number] key, then enter the page number at which to stop numbering with the number keys.

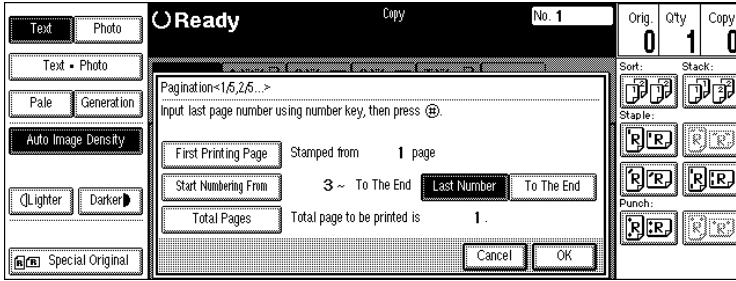

Note

- If you wish to print onto the last page, press [To The End] key and go to step 6.

- 6 Press the [#] key.

- 7 Press the [Total Pages] key, then enter the total number of original pages with the number keys.

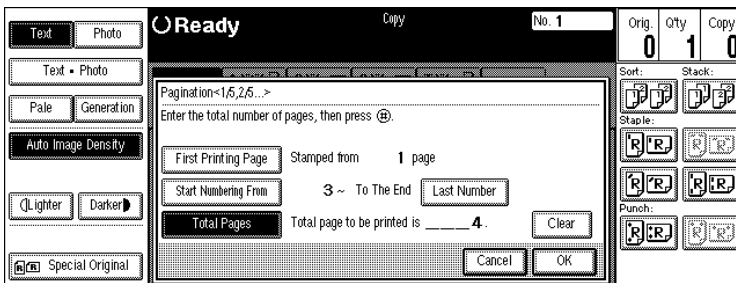

- 8 Press the [#] key.

If you selected (1-1, 1-2,...)

- 1 Press the [First Printing Page] key, then enter the original sheet number from which to start numbering with the number keys.

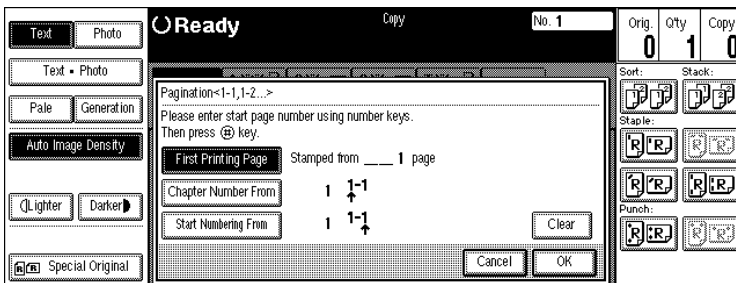

Note

- To change the number entered, press the [Clear] or [Clear/Stop] key and enter a new number.

- 2 Press the [#] key.

- 3 Press the [Chapter Number From] key, then enter the chapter number from which to start numbering with the number keys.

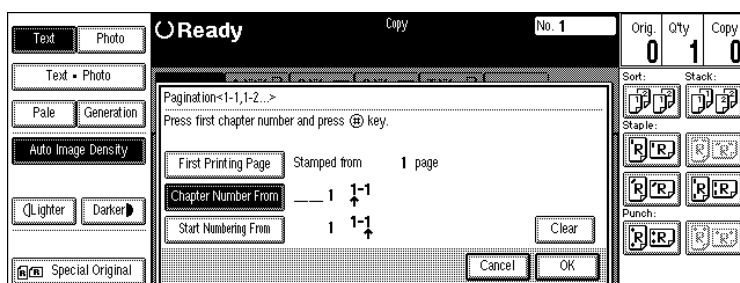

- 4 Press the [#] key.

- 5 Press the [Start Numbering From] key, then enter the page number from which to start numbering with the number keys.

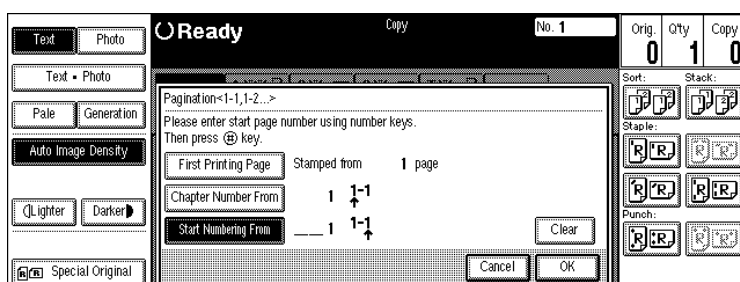

- 6 Press the [#] key.

- 9 Press the [OK] key.

Note

- To change the settings after pressing the [OK] key, press the [Change] key and enter the new value.

- 10 Press the [OK] key.

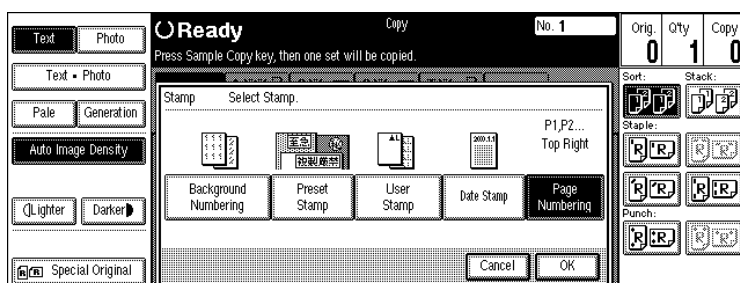

Note

- To cancel the settings, press the [Cancel] key.

- 11 Set your originals, then press the [Start] key.

Combination Chart

The combination chart given below shows which modes can be used together. When you read the chart, see the following table:

○	means that these modes can be used together.
→	means that these modes cannot be used together. The mode after you select will be the mode you're working in.
×	means that these modes cannot be used together. The mode before you select will be the mode you're working in.

The following shows the combinations of functions.

		Mode after you Select																												
		Batch (SADF)	Mixed Sizes	Selecting Copy Paper	Auto Paper Select	Auto Reduce/Enlarge	Sort	Rotate Sort	Stack	Staple	Punch	Copying From The Bypass Tray	Preset Reduce/Enlarge	Shrink&Center	Zoom	Size Magnification	Duplex	Combine	Book	Book	Book	Book	Cover/Designate/Chapters	Cover/Slip Sheet	Edit/Stamp	Stamp	Stamp	Stamp	Stamp	
Mode before you select	Batch (SADF)	○	○	○	○	○	○	○	○	○	○	○	○	○	○	○	○	○	○	○	○	○	○	○	○	○	○	○	○	○
	Mixed Sizes	○	→	○	○	○	○	×	○	○	○	○	○	○	○	○	○	○	○	○	○	○	○	○	○	○	○	○	○	○
	Selecting Copy Paper	○	○	→	○	○	○	○	○	○	○	○	○	○	○	○	○	○	○	○	○	○	○	○	○	○	○	○	○	○
	Auto Paper Select	○	○	○	→	○	○	○	○	○	○	○	○	○	○	○	○	○	○	○	○	○	○	○	○	○	○	○	○	○
	Auto Reduce/Enlarge	○	○	○	○	→	○	○	○	○	○	○	○	○	○	○	○	○	○	○	○	○	○	○	○	○	○	○	○	○
	Sort	○	○	○	○	○	○	○	○	○	○	○	○	○	○	○	○	○	○	○	○	○	○	○	○	○	○	○	○	○
	Rotate Sort	○	×	○	○	○	○	○	○	○	○	○	○	○	○	○	○	○	○	○	○	○	○	○	○	○	○	○	○	○
	Stack	○	○	○	○	○	○	○	○	○	○	○	○	○	○	○	○	○	○	○	○	○	○	○	○	○	○	○	○	○
	Staple	○	○	○	○	○	○	○	○	○	○	○	○	○	○	○	○	○	○	○	○	○	○	○	○	○	○	○	○	○
	Punch	○	○	○	○	○	○	○	○	○	○	○	○	○	○	○	○	○	○	○	○	○	○	○	○	○	○	○	○	○
	Copying From The Bypass Tray	○	○	○	○	○	○	○	○	○	○	○	○	○	○	○	○	○	○	○	○	○	○	○	○	○	○	○	○	○
	Preset Reduce/Enlarge	○	○	○	○	○	○	○	○	○	○	○	○	○	○	○	○	○	○	○	○	○	○	○	○	○	○	○	○	○
	Shrink&Center	○	○	○	○	○	○	○	○	○	○	○	○	○	○	○	○	○	○	○	○	○	○	○	○	○	○	○	○	○
	Zoom	○	○	○	○	○	○	○	○	○	○	○	○	○	○	○	○	○	○	○	○	○	○	○	○	○	○	○	○	○
	Size Magnification	○	○	○	○	○	○	○	○	○	○	○	○	○	○	○	○	○	○	○	○	○	○	○	○	○	○	○	○	○
	Duplex	○	○	○	○	○	○	○	○	○	○	○	○	○	○	○	○	○	○	○	○	○	○	○	○	○	○	○	○	○
	Combine	○	○	○	○	○	○	○	○	○	○	○	○	○	○	○	○	○	○	○	○	○	○	○	○	○	○	○	○	○

3. Document Server

Overview

The Document Server enables you to save documents in the machine memory and then edit and print them as you want.

There are two ways to save documents.

- Scanning from the document feeder
- Scanning from the exposure glass

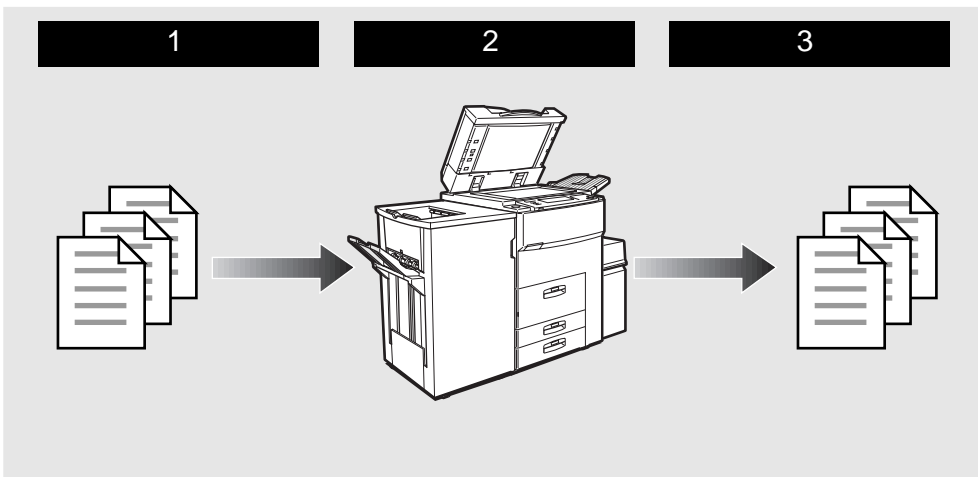

GCDCSV0E

1 Prepare the documents you want to save.

2 Save the documents.

The documents are saved in the machine memory.

3 Print the documents.

You can print saved documents with any settings you desire at any time.

Document Server Features

The following printing features are available with the Document Server.

❖ **On Demand Printing**

You can print the saved documents as you want at any time.

❖ **File Merge Printing**

You can combine multiple documents to print them in one set.

Features and Benefits

On Demand Printing

Use to print any saved document as required.

❖ Your current situation might be...

- When you need to print multiple sets of documents double-sided and stapled together, you normally print the originals, make duplex copies and then staple them together manually.

3

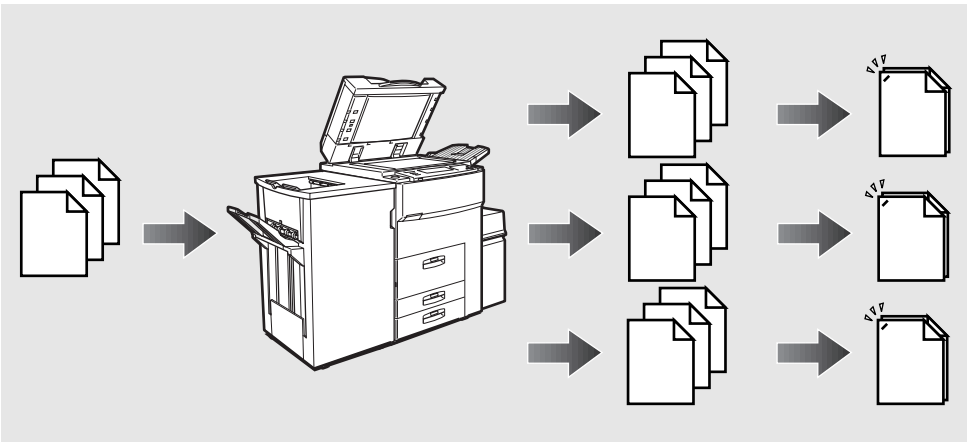

GGDCSV1E

❖ With the Document Server

If you save your document in the Document Server, you can print it out at any time with the necessary print settings, such as duplex and stapling. Your documents will not be confused with those of others in the exit tray.

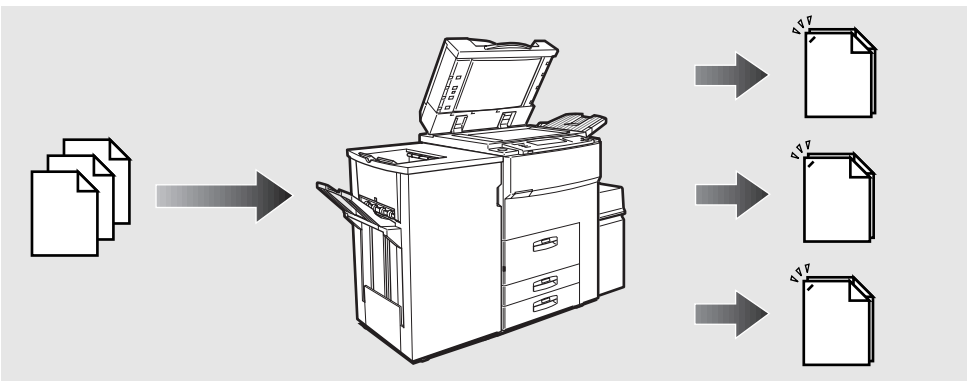

GGDCSV2E

Note

- Stapling requires the installation of the optional finisher.
- Punching requires the installation of the optional punch kit in the finisher.
- You can use a password to prevent others from printing saved documents.

File Merge Printing

You can combine multiple scanned documents to print them in one set.

❖ Your current situation might be...

You want to combine several originals that are different in density, size, and paper weight, e.g.

- Scrapped and pasted originals
- Photo originals
- One sided originals
- Two sided originals



❖ With the Document Server

You can save the originals individually by making the best settings for each original, and edit them as a file.

It does not matter whether the originals were scanned using the document feeder or the exposure glass. As you can specify the print order for several files, you can combine them as you want, and print them as a file.

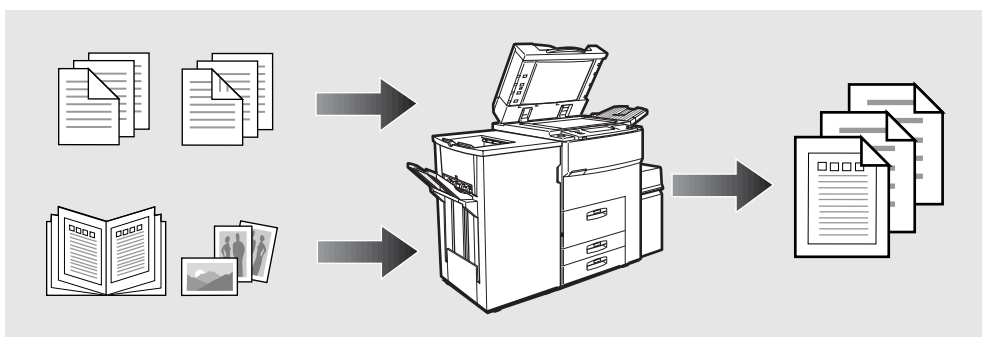

GCDCSV3E

You can check the print result by printing a sample set before making a large print run by pressing the **[Sample Copy]** key.

If you are not satisfied with the print result of some pages of the set, you have only to scan that part again.

Scanning Originals

You can scan the originals you want to save in the Document Server using the control panel of the machine. The originals can be set either on the exposure glass or into the document feeder.

The saved documents will automatically be named in the order of scanning as "Scan001", "Scan002"....

Note

- You can set the timer to delete the documents stored in the Document Server with the User Tools. See "Auto File Delete" in ⇒ P.331 "Count Manager".
- You can change the file names that are assigned automatically.
- You can use a password to prevent others from printing saved documents.

1 Press the **[Document Server/New Job]** key.

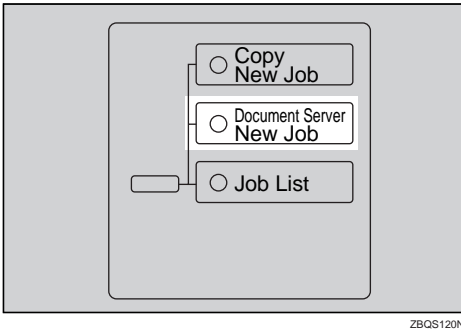

The "Document Server: Files" display appears.

2 Press the **[Scan Originals]** key.

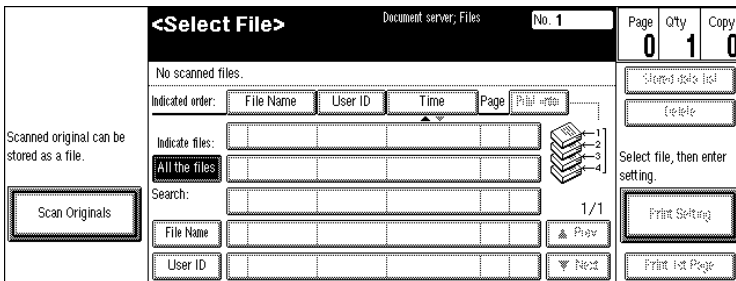

The “Doc. server: Scanning” display appears.

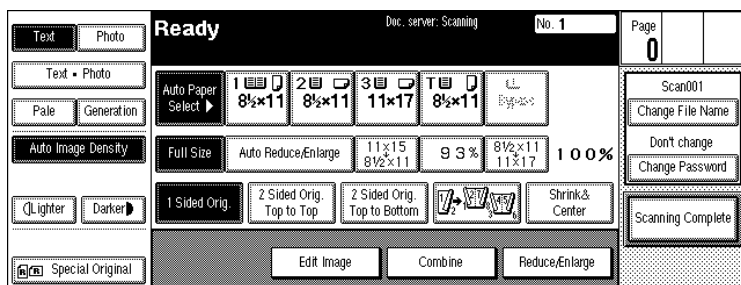

3 Enter a file name.

Note

- If you do not wish to register a file name, go to step 4.
- If you do not register a file name, it is stored automatically.

To set the file name

- 1 Press the [Change File Name] key.
- 2 Enter the new file name using the letter keys on the display panel.

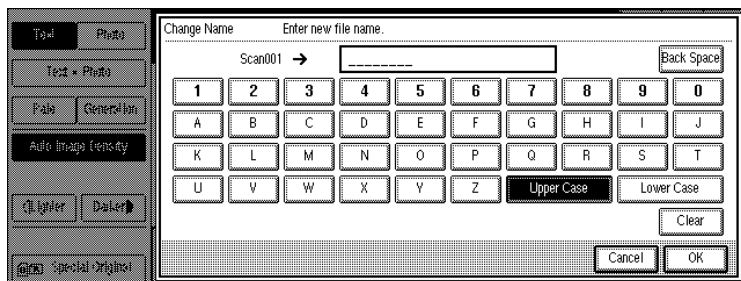

Note

- You can enter up to 8 letters.
- To switch to the capital letter mode or small letter mode, press the [Upper Case] or [Lower Case] key.
- To change the letter entered, press the [Back Space], [Clear], or [Clear/Stop] key and enter new letters. To delete the entered letters in 1 letter steps, press the [BackSpace] key. To delete all the entered letters, press the [Clear] or [Clear/Stop] key.

3 Press the [OK] key.

4 Enter your password.

Note

- If you do not wish to enter a password, go to step 5.

To set the password

- 1 Press the [Change Password] key.
- 2 Enter the password using the number keys (4 digits).

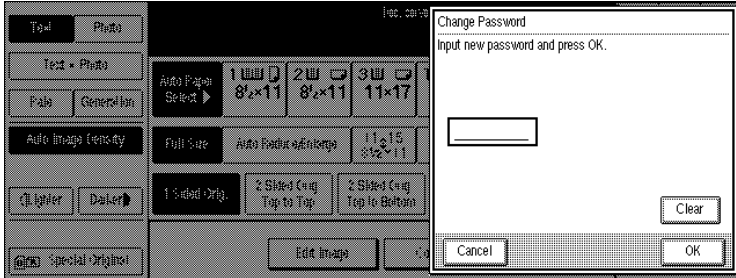

Note

- To change the number entered, press the [Clear] or [Clear/Stop] key and enter a new number.

- 3 Press the [OK] or [#] key.

- 5 Set your originals either on the exposure glass or into the document feeder.

Reference

For more information on the types of originals that can be set and how to set them, see ⇒ P.31 “Setting Originals”.

- 6 Make any desired settings.

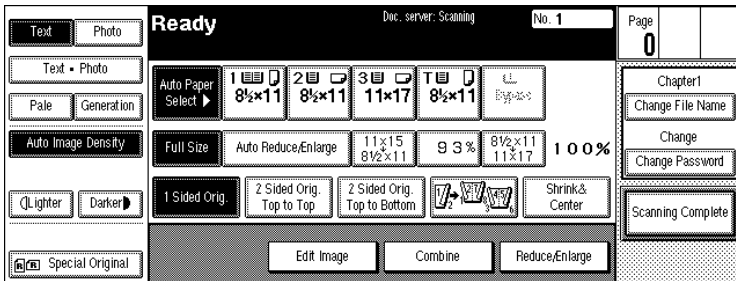

Note

- Press the [Scanning Complete] key to cancel the file name, password, or print settings and return to the “Document Server: Files” display.

Reference

For details, see the explanations of each function in this manual.

- 7 Press the [Start] key.

The document is saved in the Document Server. The saved documents are displayed on the “Document Server: Files” display.

Note

- ❑ If you have set your originals in the document feeder, the “Document Server: Files” display appears automatically after all originals have been scanned.
- ❑ If you have set your originals on the exposure glass, press the **[Scanning Complete]** key after all originals have been scanned. The “Document Server: Files” display appears.
- ❑ To stop scanning, press the **[Clear/Stop]** key.
- ❑ To resume the paused scanning job, press the **[Resume]** key in the confirmation dialog box. To delete the saved images and cancel the job, press the **[Cancel]** key.
- ❑ When storing a password, **1** appears on the left side of the file name.

To change the file name or password

- 1** Press the line of the document whose file name or password you want to change.

Indicated order	File Name	User ID	Time	Page	Print order
1	Chapter1		4/ 2 14:03	6	1
2	Chapter2		4/ 2 14:04	4	
3	Chapter3		4/ 2 14:06	3	

- 2** If you select a document which requires a password, the “Input the Password” window appears. Input the password using the number keys, then press the **[OK]** key.
- 3** Press the **[Stored data list]** key.
- 4** Press the **[Change File Name]** or **[Change Password]** key.

Indicated order	File Name	User ID	Time	Page	Print order
1	Chapter1		4/ 2 14:03	6	1
2	Chapter2		4/ 2 14:04	4	
3	Chapter3		4/ 2 14:06	3	

- 5** Enter the new file name or password using the letter keys or number keys.
- 6** Press the **[OK]** key.

Printing Saved Documents

You can print any of the documents saved in the Document Server. Follow these steps to select a document and print it out.

1 Press the **[Document Server/New Job]** key.

The “Document Server: Files” display appears.

2 Press the line for the document you want to print.

3

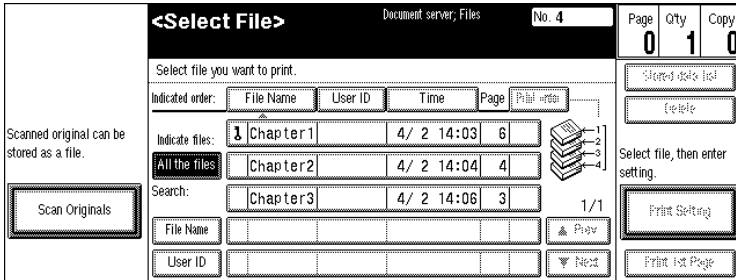

The selected line is highlighted.

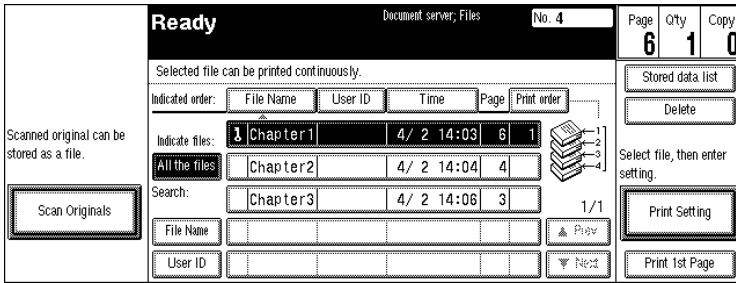

Note

- You can search the document you desire by the file name. See ⇒ P.219 “To Search by File Name”.
- You can sort the files in order of **[File Name]**, **[Time]**, or **[Print order]**. Press the key you want to sort by.
- If the desired file name is not shown, see the next or previous screen using the **[▼ Next]** and **[▲ Prev.]** keys.
- If you cannot choose the desired document by its name, you can print the first page to check the contents. Press the line for the desired document, and press the **[Print 1st Page]** key followed by the **[Start]** key.
- Press the selected line again to cancel the print job.
- If you select a document which requires a password, the “Input the Password” window appears. Enter your password using the number keys, then press the **[OK]** key. To delete the value entered, press the **[Clear]** or **[Clear/Stop]** key. To cancel a selected document, press the **[Cancel]** key.

3 To print more than one document, repeat step **2** to select the desired documents in the order you want to print them out.

The selected order is shown in the priority column next to the selected document(s).

Note

- To change the print order, press the highlighted lines to return to the normal conditions, then select them again in the order you want to print.
- Press the **[Clear Modes/Energy Saver]** key to cancel all the settings.

4 If you need to change any of the print settings, press the **[Print Setting]** key.

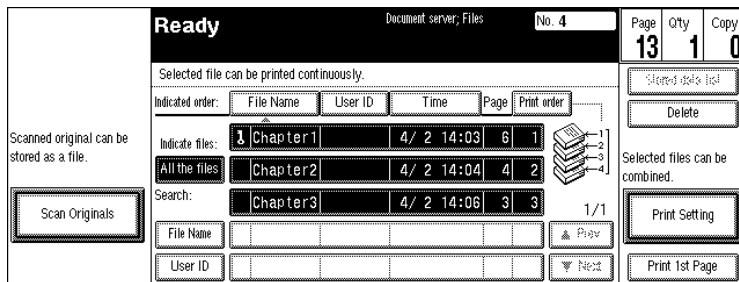

The "Document Server: Print Conditions" display appears.

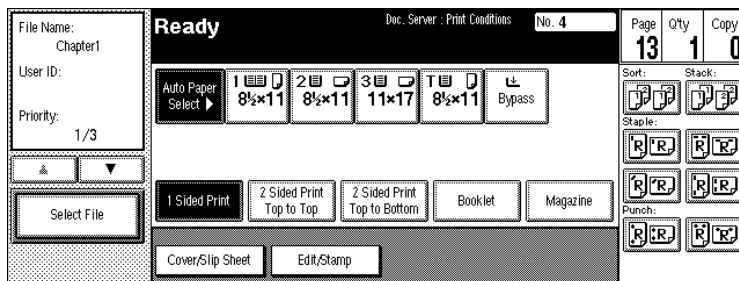

Note

- The print settings remain in the machine after printing.
- The print settings of the document you select first are applied to the merged documents.
- If you select multiple files, you can confirm the file names or print order of the files you selected in step **3** by scrolling through the list with the **[▼]** and **[▲]** keys.
- Press the **[Select File]** key to return to the "Document Server: Files" display.

Reference

For details, see the explanations of each function in this manual.

5 Enter the required number of prints using the number keys.

Note

- Up to 999 can be entered.

- To change the value entered, press the **[Clear/Stop]** key and enter new value.
- If you print more than one set using the Sort function, you can check the print result by printing out only the first set. See ⇒ P.218 “Sample Printing”.

6 Press the **[Start]** key.

The machine starts printing.

Note

- To pause the print job, press the **[Clear/Stop]** key. In the confirmation dialog box, press the **[Resume]** key to resume it, or press the **[Cancel]** key to cancel it.

3

Sample Printing

If you print multiple sets using the Sort function, you can check if the print order or the print settings are correct by printing out only the first set using the **[Sample Copy]** key.

Limitation

- This function can be used only when the Sort function has been turned on.

1 Follow steps **1** to **5** of the preceding procedure.

2 Press the **[Sample Copy]** key.

3 After the first set is printed out, press the **[Resume]** key to print the rest of the print job. Press the **[Cancel]** key to cancel it and return back to the “Document Server: Print Conditions” menu for changing the setting.

Print First Page

You can print the first page of the document selected in the “Document Server: Files” display to check the contents.

If more than one document is selected, the first page of each document is printed.

1 Press the line for the desired document(s) in the “Document Server: Files” display, and press the **[Print 1st Page]** key.

2 Press the **[Start]** key.

The first page is printed out.

To Search by File Name

You can search the document stored in the Document Server by the file name.

1 Press the **[Document Server/New Job]** key.

The “Document Server: Files” display appears.

2 Press the **[File Name]** key.

3 Enter the file name using the letter keys.

 **Note**

- You can enter up to 8 letters.
- To switch to the capital letter mode or small letter mode, press the **[Upper Case]** or **[Lower Case]** key.
- To change the letter entered, press the **[Back Space]**, **[Clear]**, or **[Clear/Stop]** key and enter new letters. To delete the entered letters in 1 letter steps, press the **[Back Space]** key. To delete all the entered letters, press the **[Clear]** or **[Clear/Stop]** key.

4 Press the **[OK]** key.

Only the files beginning with the letters appear in the “Document Server: Files” display.

 **Note**

- To display all the files saved in the Document Server, press the **[All the files]** key.

Deleting Saved Documents

You should delete any of the saved documents using the control panel of the machine.

This section describes how to delete saved documents.

Important

- You can save up to 200 documents in the Document Server. No more documents can be saved, when there are 200 documents in the Document Server. You should delete unnecessary documents.
- You can set the timer to delete the documents stored in the Document Server with the User Tools. See “Auto File Delete” in ⇒ P.331 “Count Manager”.

Note

- You can delete all the saved documents at a time with the User Tools. See “Delete All The Saved Files” in ⇒ P.331 “Count Manager”.

Follow these steps to delete saved documents.

1 Press the **[Document Server/New Job]** key.

The “Document Server: Files” display appears.

2 Select a document you want to delete by pressing the name of it.

The selected name is highlighted.

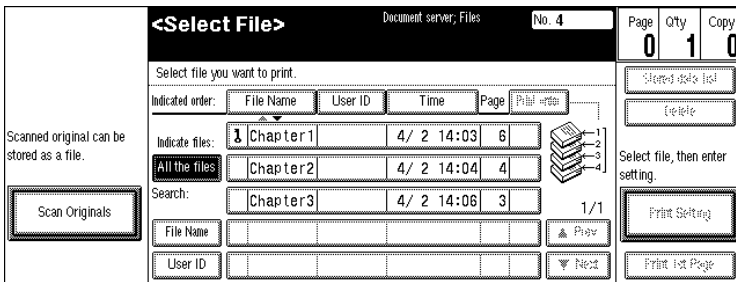

Indicated order	File Name	User ID	Time	Page	Print order
1	Chapter1		4/ 2 14:03	6	1
2	Chapter2		4/ 2 14:04	4	2
3	Chapter3		4/ 2 14:06	3	3

Scanned original can be stored as a file.

Search:

File Name:

User ID:

Page Qty Copy: 0 1 0

Buttons: Scan Originals, Print Setting, Print 1st Page, Selected state list, Delete, Select file, then enter setting.

Note

- You can search the document you desire by the file name. See ⇒ P.219 “To Search by File Name”.
- You can sort the files in order of **[File Name]**, **[Time]**, or **[Print order]**. Press the key you want to sort by.
- If the desired file name is not shown, see the next or previous screen using the **[▼ Next]** and **[▲ Prev.]** keys.
- If you cannot choose the desired document by its name, you can print the first page to check the contents. Press the line for the desired document, and press the **[Print 1st Page]** key followed by the **[Start]** key.
- Press the selected line again to cancel the print job.

4. Connect Copy (Option)

What is Connect Copy?

Connect Copy is a feature that allows you to connect two machines together using a cable. When you set up your copy job on one machine (the master unit), data is transferred to the other machine (the sub-unit) so that copies can be made on both machines simultaneously.

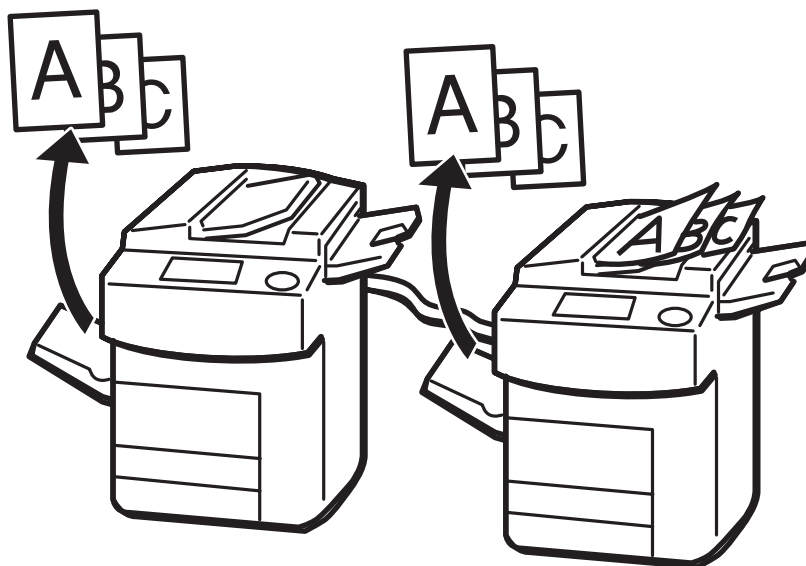

GCC

Connect Copy benefits

Connect Copy provides the following benefits:

❖ **High-speed copying for greater productivity**

For large volume copy runs, two connected machines form a single system that can complete the job in a shorter time. If two 70 copies/minute (A4 □, 8¹/₂" × 11" □ size) copiers are connected together, a 140 copies/minute (A4 □, 8¹/₂" × 11" □ size) speed will be available.

❖ **Auto-backup system for less participation of operators**

Even if one machine stops because of a paper jam, it has run out of toner, or run out of paper, the other machine will take over and finish the job automatically. If the stopped machine is recovered, the machines will allocate the job again and continue using Connect Copy to complete the job in a way that results in maximum productivity.

 **Note**

- You cannot make other copy jobs when two machines are connected.
- The two machines automatically share the job in order to finish at almost the same time and provide maximum productivity.
- To use the two machines separately again, press the **[Connect]** key to disconnect them.

How Connect Copy Works

In this manual, we refer to the two machines as the master unit and sub-unit respectively.

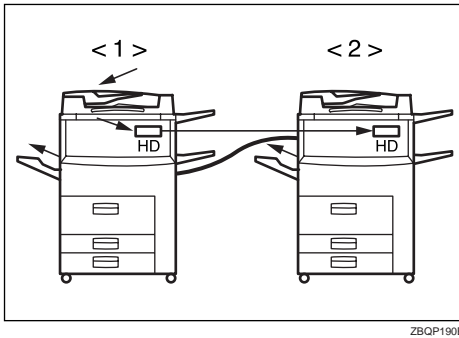

1. Master unit

2. Sub-unit

As your original is scanned in, the image data is stored on the master unit hard disk and transferred simultaneously to the sub-unit hard disk. As soon as scanning has finished, copying starts.

The master unit is the machine at which you press the **[Connect]** key to enter Connect Copy mode. When you do this, the other machine becomes the sub-unit. You can use either machine as the master unit or sub-unit, but you cannot change the relationship without exiting Connect Copy mode first.

Connectable Copier Models

- The master unit and sub-unit do not have to be same speed models.

Master Unit	Sub-Unit
55 copies/minute copier	55 copies/minute copier
55 copies/minute copier	70 copies/minute copier
70 copies/minute copier	55 copies/minute copier
70 copies/minute copier	70 copies/minute copier

- You can still use Connect Copy even if no optional finisher, booklet finisher, or large capacity tray (LCT) is available. However, the optional finisher must be installed in both units in order to use the Stack and Staple functions, the optional finisher and punch kit must be installed in both units in order to use the Punch function, and the optional booklet finisher must be installed in both units in order to use the Stack and Saddle Stitch function.

Functions Not Available with Connect Copy

The following functions are not available in Connect Copy mode:

- Job Preset

Interrupt Functions

- You cannot use Connect Copy when a job has been paused using the Interrupt function.
- You can use the Interrupt function on the sub-unit while in Connect Copy mode, but only when the master unit is not scanning originals.

4

Before You Start

Both units must have paper trays loaded with paper of the same size, direction and type that you wish to copy onto.

To make the most out of the Connect Copy feature, we recommend that:

- The paper tray settings of the master unit and sub-unit match each other.
- The “Original Mode Quality Level” of the User Tools settings should be the same on each unit. If they are not the same, the copied images may differ. See “Original Mode Quality Level” in ⇒ P.310 “General Features ¹/₃”.
- If the installations of the optional finisher or booklet finisher in both units are not the same, the copied images may differ.



Connect Copy Display Panel

This section describes the displays on the master unit and sub-unit.

Note that when you enter Connect Copy mode, you must access all Connect Copy features and menus through the master unit display panel.

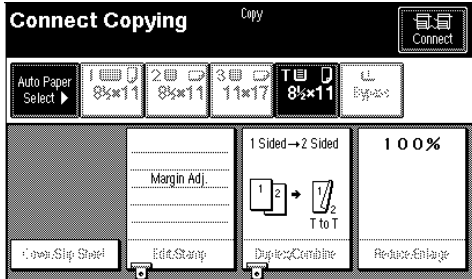
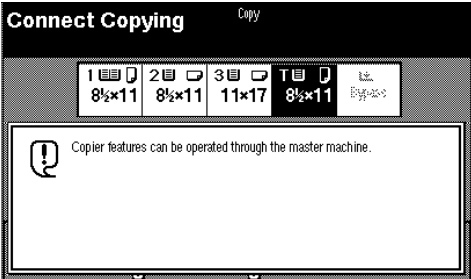
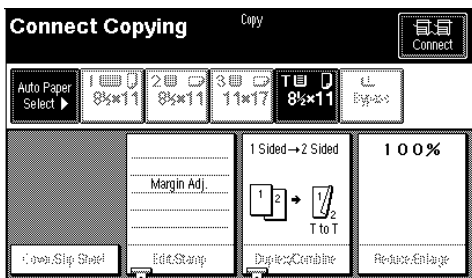
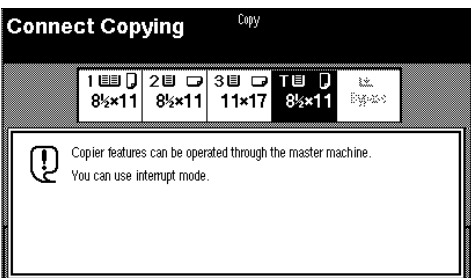
	Master unit	Sub-unit
Initial display in standard copy mode		
Initial display in Connect Copy mode		

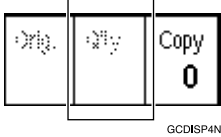
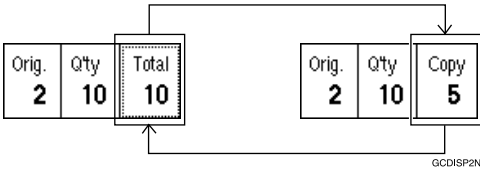
	Master unit	Sub-unit												
Display when scanning originals on the master unit														
Display when copying/Interrupt copying														
Number of originals	<p>How many original pages have been scanned by the master unit so far.</p> <table border="1" data-bbox="336 1489 565 1619"> <tr> <td>Orig.</td> <td>Qty</td> <td>Copy</td> </tr> <tr> <td>2</td> <td>10</td> <td>5</td> </tr> </table> <p style="text-align: center; font-size: small;">GCDISP0N</p>	Orig.	Qty	Copy	2	10	5	<p>Not displayed on sub-unit.</p> <table border="1" data-bbox="847 1460 1081 1580"> <tr> <td>Orig.</td> <td>Qty</td> <td>Copy</td> </tr> <tr> <td></td> <td></td> <td>0</td> </tr> </table> <p style="text-align: right; font-size: x-small;">GCDISP0N</p>	Orig.	Qty	Copy			0
Orig.	Qty	Copy												
2	10	5												
Orig.	Qty	Copy												
		0												

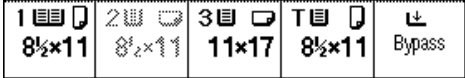
	Master unit	Sub-unit
Copy quantity	<p>How many sets/copies to make.</p> 	<p>Not displayed on sub-unit.</p> 
Copy counter	<p>Displays how many sets/copies made by the master unit so far. *1</p> 	<p>Displays how many sets/copies made by the sub-unit so far.</p> 
Copy Paper Select	<p>Only paper trays loaded with the paper of the same size, direction and type installed in both the master unit and sub-unit are displayed.</p> <p>Other paper tray types will be grayed out and you cannot select them. *2</p> 	<p>Only paper trays loaded with the paper of the same size, direction and type installed in both the master unit and sub-unit are available.</p> <p>Note that you can only select the copy paper from the master unit control panel.</p> 

*1 When two or more pages are being copied using Sort and Staple, you can check how many sets have been copied so far. To toggle the copy counter between the master unit total and the total for both units, press the area that displays the number of copies. "Copy" means the number of sets made so far by the master unit and "Total" means the total number of sets made so far by both units.

*2 The bypass tray can be used only for the Cover/Designate functions.

Using Connect Copy

You can select Connect Copy mode from either of the two connected machines by pressing the **[Connect]** key. The machine you use becomes the master unit, and the other machine the sub-unit.

Limitation

- Once Connect Copy is selected, you must carry out all operations on the master unit.

Note

- You can select whether the **[Connect]** key is displayed or not with the User Tools. See “Connect Copy Master” in ⇒ P.331 “Count Manager”.

4

1 Make sure that the machine is in Copy mode.

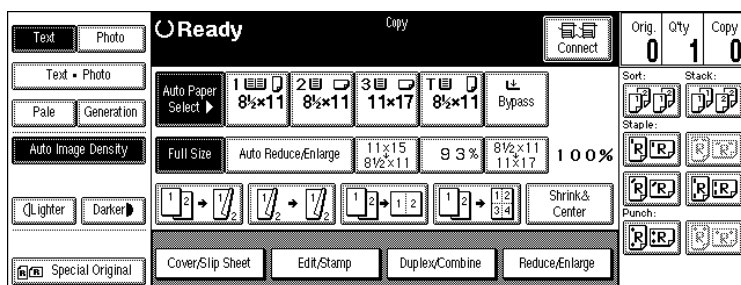

Note

- If the User Codes are turned on, enter a user code programmed in the master unit using the number keys (maximum 8 digits) then press the **[#]** key. You do not need to enter the user code for the sub-unit.

Reference

⇒ P.90 “User Codes”

2 Press the **[Connect]** key on the machine that is to be the master unit.

When the key darkens, the two units are connected.

Master unit display

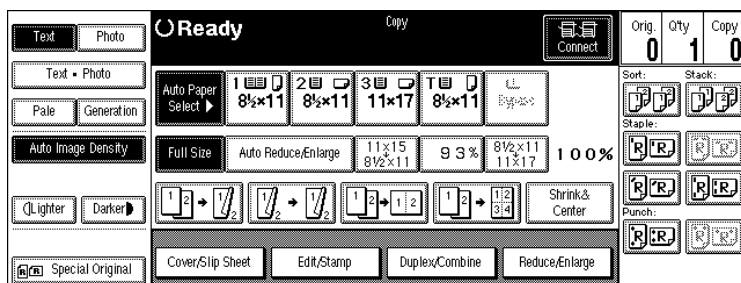

❖ Sub-unit display

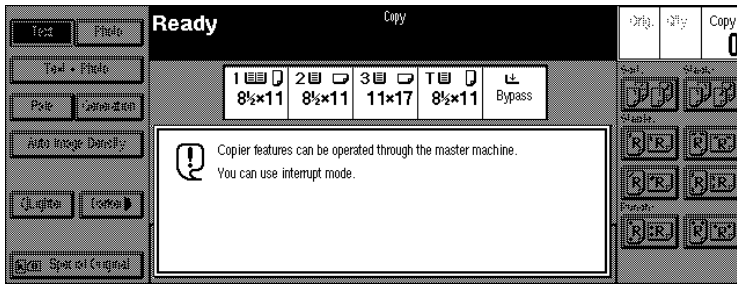

🔍 Reference

If the **[Connect]** key is not visible or you cannot select it, see ⇒ P.252 “Connect Copy”.

If you press the **[Connect]** key and the message “Connect Copy is not available at this time. Please check the connected machine. Press **[Cancel]**, connect copy will be cancelled.” appears, see ⇒ P.249 “Connect Copy”.

4

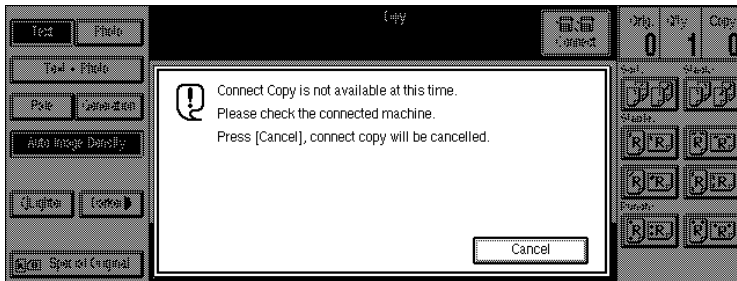

3 Set your originals in the master unit.

	Original	Exposure glass	Document feeder
Standard			
90° Turn			

G0GSET1E

🔍 Reference

⇒ P.31 “Setting Originals”

4 Make any settings you require on the master unit.

Note

- ❑ Any copy settings that were set up before you entered Connect Copy mode will still remain in effect. However, if optional finishers are not installed on both the master unit and sub-unit, the Stack, Staple and Punch functions will be automatically disabled.
- ❑ To exit Connect Copy mode, press the **[Connect]** key on the master unit again.

Reference

For more information on functions you can use with Connect Copy, see ⇒ P.13 "Function List Based on Options".

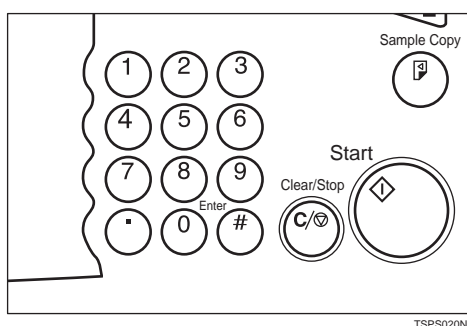
5 Enter the number of copies you require using the number keys.**Note**

- ❑ You can enter up to 999 copies.
- ❑ If you make a mistake, press the **[Clear/Stop]** key and enter a new number.
- ❑ Even though Connect Copy is selected, only the master unit will make copies in the following situations:
 - When making a single copy set
 - When the original is a single sheet and you enter a low number of copies/sets

6 Press the **[Start] key on the master unit.**

Copying starts after the original has been scanned.

If you set originals in the document feeder

- 1** Copying starts simultaneously in the master unit and sub-unit after all originals have been scanned.
-

If you set originals on the exposure glass

- 1** Set the next page(s) when scanning has finished, then press **[Start]** key.
- 2** When all pages have been scanned in, press the **[#]** key. Copying starts simultaneously in the master unit and sub-unit.

If you use Batch (SADF) mode

- ❶ Set your originals and press the **[Start]** key. After all the previously set originals are fed, set the next originals while the Auto Feed indicator is lit.
- ❷ When all pages have been scanned in, press the **[#]** key. Copying starts simultaneously in the master and sub-unit.

Note

- To stop originals from being scanned or copied, press the **[Clear/Stop]** key on the master unit, then press the **[Cancel]** key following the instructions on the display.

Reference

See ⇒ P.36 “Batch (SADF) mode”.

If the size of scanned data exceeds memory capacity, the memory overflow message is displayed. Follow the instructions in “When Memory Is Full”. See ⇒ P.262 “Connect Copy”.

7 Pick up your copies from the master unit and sub-unit.

Note

- The number of sheets and sets copied by the master unit and sub-unit may be different.
- The master unit and sub-unit may not finish copying at the same time.
- When using the Sort/Staple function, copies are organized into copy sets. If there is a paper jam in one machine during this process, it is not possible for the other machine to take over the copy set processing of the down machine.

Copy output order

❖ When copying in Sort/Staple mode

e.g., copying 6-sets of a 3-sheet original

- Copying with the master unit (face down output)—sub-unit (face down output)

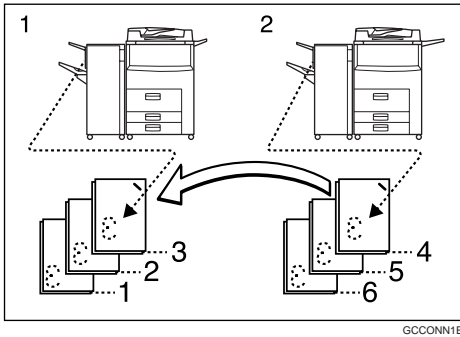

1. Master unit

2. Sub-unit

When using Sort/Staple, your copies sets are not split between the master unit and sub-unit.

❖ When copying without Sort/Staple mode

e.g., making 2 copies of each page of a 6-sheet original

- Copying with the master unit (face down output)—sub-unit (face up output)

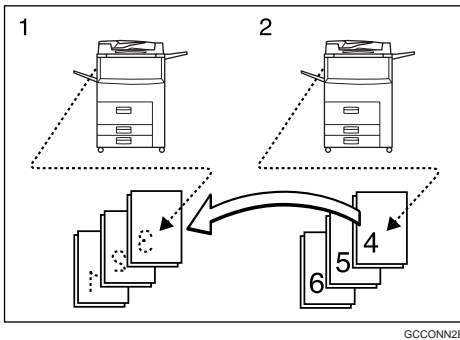

1. Master Unit

2. Sub-Unit

Combine your copy stacks from the master unit and sub-unit as shown in the diagram.

💡 Auto Reset

The machine exits Connect Copy mode and automatically returns to the initial condition a certain period of time after your job has finished. This function is called "Auto Reset".

Note

- When the master unit “Auto Reset Timer” of the User Tools delay elapses, the master unit will be reset automatically.
- When the sub-unit “System Reset” of the User Tools (System Settings) delay elapses, Interrupt mode will be cancelled on the sub-unit.

Reference

See “Auto Reset Timer” in ⇒ P.310 “General Features ¹/₃”.

See “System Reset” in the System Settings manual.

Auto Off

The machine turns itself off automatically a certain period of time after your job has finished. This function is called “Auto Off”.

Note

- You can change the Auto Off time.

Reference

See “Auto Off Timer” in the System Settings manual.

Exiting Connect Copy Mode

This procedure describes how to exit Connect Copy mode and return to the standard copying functions.

1 Press the [Connect] key on the master unit.

The [Connect] key will be deselected.

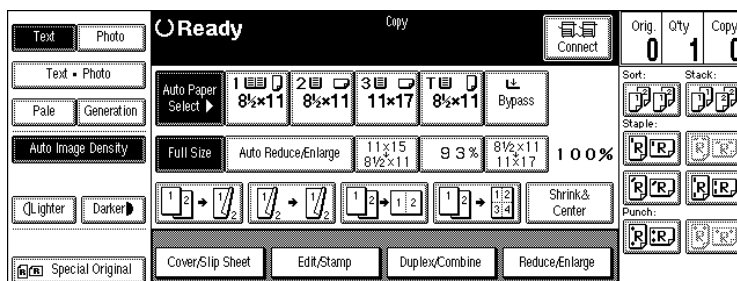
**Note**

- Settings that were selected on the master unit while in Connect Copy mode will not be cleared.

- You can sort the files in order of **[File Name]**, **[Time]**, or **[Print order]**. Press the key you want to sort by.
- If the desired file name is not shown, see the next or previous screen using the **[▼ Next]** and **[▲ Prev.]** keys.
- If you cannot choose the desired document by its name, you can print the first page to check the contents. Press the line for the desired document, and press the **[Print 1st Page]** key followed by the **[Start]** key.
- Press the selected line again to cancel the print job.
- If you select a document which requires a password, the “Input the Password” window appears. Enter your password using the number keys, and press the **[OK]** key. To delete the value entered, press the **[Clear]** or **[Clear/Stop]** key. To cancel a selected document, press the **[Cancel]** key.

3 To print more than one document, repeat step 2 to select the desired documents in the order you want to print them out.

The selected order is shown in the priority column next to the selected document(s).

Note

- To change the print order, press the highlighted lines to return to the normal conditions, then select them again in the order you want to print.
- Press the **[Clear Modes/Energy Saver]** key to cancel all the settings.

4 If you need to change any of the print settings, press the [Print Setting] key.

Indicated order:	File Name	User ID	Time	Page	Print order
1	Chapter1		4/ 2 14:03	6	1
	Chapter2		4/ 2 14:04	4	
	Chapter3		4/ 2 14:06	3	

The “Document Server: Print Conditions” menu appears.

Note

- The print settings remain in the machine after printing.

- The print settings of the document you select first are applied to the merged documents.
- If you select multiple files, you can confirm the file names or print order of the files you selected in step 3 by scrolling through the list with the [▼] and [▲] keys.
- Press the [Select File] key to return to the “Document Server: Files” display.

Reference

For details, see the explanations of each function in this manual.

5 Press the [Connect] key.

When the key darkens, the two units are connected.

6 Enter the required number of prints using the number keys.

Note

- Up to 999 can be entered.
- To change the value entered, press the [Clear/Stop] key and enter a new value.
- If you print more than one set using the Sort function, you can check the print result by printing out only the first set. See ⇒ P.218 “Sample Printing”.

7 Press the [Start] key.

Printing starts after the image data stored in the master unit has been transferred to the sub-unit.

Note

- The printing may take some time after transferring the image data to the sub-unit.
- To stop originals from being printed, press the [Clear/Stop] key on the master unit, then press the [Cancel] key following the instructions on the display.
- The number of sheets and sets printed by the master unit and sub-unit may be different.
- The master unit and sub-unit may not finish printing at the same time.

Relationship Between Master Unit and Sub-Unit System Settings

This section describes which System Settings are used by the master unit and sub-unit in Connect Copy mode.

Note

- In Connect Copy mode, the **[User Tools/Counter]** key on the sub-unit is disabled. To access the User Tools on the sub-unit, you need to exit Connect Copy mode first.

Reference

For details, see the System Settings manual.

Symbol	Meaning
☆	The master unit and sub-unit use each setting
←	Both units use the master unit setting
—	Unrelated
★	Depends on the function

Menu	Master unit	Sub-unit	Remarks
Basic Page 1			
Operation Panel Beeper	☆	☆	
Ready Operation Panel Beeper	☆	☆	
Copy Count Display	—	—	The copy counter is always displayed in count up mode.
Auto Response (Human) Sensor	☆	Invalid	Disabled even if the sub-unit setting is "Yes".
Auto Tray Switching	☆	☆	
Auto Off Timer	☆	—	
Low Power Shift Time	—	—	In Connect Copy mode, neither unit will enter any of Energy Saver modes (Low Power mode, Energy Saver mode). When Connect Copy is exited, the machines will enter Energy Saver mode after the programmed delay elapses.
Low Power Timer	—	—	

Menu	Master unit	Sub-unit	Remarks
ADF Orig. Ejection	☆	—	
<F/F4>Size Setting	☆	☆	
Basic Page 2			
System Reset	—	★	Interrupt mode on the sub-unit will be cleared by this timer.
Function Priority	—	—	When the time set in “Auto Reset Timer” of the User Tools on the master unit passes and Connect Copy is canceled, and then the time set in “System Reset” of the User Tools (System Settings) passes, it returns to the function defined by the “Function Priority” of the User Tools (System Settings) setting.
Copy/Document Server: Output Tray	☆	☆	
Staple initialization	—	—	
Set Time			
Set Date	☆	☆	
Set Time	☆	☆	
Weekly Timer:Monday to Sunday	☆	—	The function is disabled on the sub-unit in Connect Copy mode. When Connect Copy is exited, the power will be switched off at the time specified by the timer.
Key Operator Code for Off Setting	—	—	
Paper Size Setting			
Paper Tray Priority	☆	☆	
Tray 1:Paper Size Setting	☆	☆	We recommend that the master unit and sub-unit have the same paper tray settings. This is because only paper trays with the same size, direction, and type of paper can be used in Connect Copy mode.
Tray 2:Paper Size Setting	☆	☆	
Tray 3:Paper Size Setting	☆	☆	

Menu	Master unit	Sub-unit	Remarks
Bypass: Special Paper Indication	★	★	Can be used only with the Cover/Designate functions.
Tray 1: Special Paper Indication	☆	☆	We recommend that the master unit and sub-unit have the same paper tray settings. This is because only paper trays with the same size, direction, and type of paper can be used in Connect Copy mode.
Tray 2: Special Paper Indication	☆	☆	
Tray 3: Special Paper Indication	☆	☆	
LCT: Special Paper Indication	☆	☆	
Cover	☆	☆	
Slip Sheet 1	☆	☆	
Slip Sheet 2	☆	☆	
Count Manager			
Set User Codes	☆	—	Access these settings on the master unit. The master unit settings override those of the sub-unit.
Key Counter	—	—	You cannot control the optional Key Counter in Connect Copy mode.
Set Key Card	☆	—	—
Key Operator Code	—	—	
AOF(Keep It On.)	—	—	Neither the master unit nor sub-unit will be turned off by this function in Connect Copy mode. The power will go off after you have exited Connect Copy mode and the AOF Delay has elapsed.
Counter/Print	—	—	

Relationship Between Master Unit and Sub-Unit Copy/Document Server Features

This section describes which Copy/Document Server Features are used by the master unit and sub-unit in Connect Copy mode.

Note

- ❑ In Connect Copy mode, the **[User Tools/Counter]** key on the sub-unit is disabled. To access the User Tools on the sub-unit, you need to exit Connect Copy mode first.

Reference

⇒ P.305 “User Tools (Copy/Document Server Features)”

Symbol	Meaning
☆	The master unit and sub-unit use each setting
←	Both units use the master unit setting
—	Unrelated

Menu	Master unit	Sub-unit	Remarks
General Features			
Auto Paper Select Priority	☆	—	Trays with the same size and direction of paper will be selected from the master unit and sub-unit automatically.
Auto Paper Select Tray Display	☆	—	The sub-unit displays the type of paper whether this function is selected or not.
Auto Image Density Priority	☆	—	
Original Mode Priority	☆	—	
Original Mode Display	☆	—	
Original Mode Quality Level	☆	☆	Same level should be selected on both units.
Original Image Density Level	☆	☆	Each unit uses its own programmed value.
Auto Reset Timer	☆	—	Connect Copy will be cancelled according to the timer on the master unit.
Duplex Mode Priority	☆	—	

Menu	Master unit	Sub-unit	Remarks
Copy Orientation in Duplex Mode	☆	—	
Original Orientation in Duplex Mode	☆	—	
Initial Mode	☆	—	
Maximum Copy Quantity	☆	—	
Original Beeper	☆	—	
Job End Call	☆	☆	When turned on, the beeper sounds only on the master unit when copying is completed. Only if the "Operation Panel Beeper" of the User Tools (System Settings) setting is "On".
Time for indicating job status	—	—	
Shortcut Keys:F1	☆	—	
Shortcut Keys:F2	☆	—	
Shortcut Keys:F3	☆	—	
Shortcut Keys:F4	☆	—	
Shortcut Keys:F5	☆	—	
Reproduction Ratio			
Shortcut R/E	☆	—	
R/E Priority	☆	—	
Enlarge 1 – 5	☆	—	
Priority Setting : Enlarge	☆	—	
Reduce 1 – 6	☆	—	
Priority Setting : Reduce	☆	—	
Shrink&Center Ratio	☆	—	
Page Format			
Front Margin: Left/Right	☆	←	
Back Margin: Left/Right	☆	←	
Front Margin: Top/Bottom	☆	←	

Menu	Master unit	Sub-unit	Remarks
Back Margin: Top/Bottom	☆	←	
1 → 2 Duplex Auto Margin Adjust	☆	←	
Erase Border	☆	←	
Combine Orig. Shadow Erase	☆	←	
Erase Center	☆	←	
Repeat Separation Line	☆	←	
Double Copies Separation Line	☆	←	
Combine Separation Line	☆	←	
Copy Back Cover	☆	←	
Cover page in combine mode	☆	←	
Designated Slip Sheet Copy In Combine	☆	←	
Booklet/Magazine Original Orientation	☆	←	
Copy Order In Combine Mode	☆	←	
Stamp Setting			
Background Numbering			
Size	☆	←	
Density	☆	←	
Superimpose	☆	←	
Preset Stamp			
Stamp Priority	☆	←	
Stamp Language	☆	←	
Stamp position	☆	←	
Stamp condition	☆	←	
Superimpose	☆	←	
User Stamp			

Menu	Master unit	Sub-unit	Remarks
Program/Delete Stamp	☆	←	Set the same stamp in the both unit.
Stamp position	☆	←	
Stamp condition	☆	←	
Date Stamp			
Format	☆	←	
Font	☆	←	
Position Priority	☆	←	
Size	☆	←	
Superimpose	☆	←	
Page Numbering			
Format Priority	☆	←	
Font	☆	←	
Size	☆	←	
Duplex Back Page Number Position	☆	←	
Page Numbering In Combine Mode	☆	←	
Copy On Slip Sheet In Designate Mode	☆	←	
Position Priority: P1, P2...	☆	←	
Position Priority: 1/5, 2/5...	☆	←	
Position Priority: -1-, -2-...	☆	←	
Position Priority: P.1, P.2...	☆	←	
Position Priority: 1, 2...	☆	←	
Position Priority: 1-1,1-2...	☆	←	
Superimpose	☆	←	
Input/Output			
Batch (SADF) Auto Reset Time	☆	—	
ARDF Original Table Rise Time	☆	—	

Menu	Master unit	Sub-unit	Remarks
Face-Up/Down Selection in Platen Mode	—	—	This setting will be ignored and the setting programmed for Connect Copy will be used. 🔍 Reference See step 7 in ⇒ P.230 “Using Connect Copy”.
Rotate Sort Auto Paper Continue	☆	←	This function is effective when the “Auto Tray Switching” of the User Tools (System Settings) setting is “On (Rotate)”.
Auto Sort Mode	☆	—	
Memory Full Auto Scan Restart	☆	←	
Select Stack or Rotate sort	☆	—	
Staple Position	☆	—	
Paper Eject: Always Rotate 180°	☆	←	
Count Manager			
Check/Reset/Print Copy Counter	—	—	
User Code Register/Change/Delete	—	—	
Face-Up/Down Selection in Bypass Mode	—	—	
Connect Copy Master	☆	—	
Auto File Delete	☆	—	
Delete All The Saved Files	—	—	

5. What to Do If Something Goes Wrong

If Your Machine Does Not Operate as You Want

General

Machine Status	Problem/Cause	Action
The machine instructs you to wait.	The machine is warming up.	Wait for the machine to warm-up.  Reference You can use Auto Start mode during warm-up period. See ⇒ P.90 "Auto Start".
	Copy paper is moving in tray 1 (Tandem Tray).	Wait for the machine.
The machine cannot detect the original size.	Improper original is set. See ⇒ P.21 "Sizes difficult to detect".	Set non-standard size original on the exposure glass. See ⇒ P.31 "Setting Originals on the Exposure Glass".
		Select paper manually, not in Auto Paper Select mode.
	Do not use Auto Reduce/Enlarge mode.	
	Original is not set.	Set your originals.
The machine instructs you to check the original direction.	There is no copy paper that is in the same direction as the originals.	Set the original in the same direction as the copy paper.
The machine instructs you to check paper size.	Improper original size is set.	Select the proper paper size.
The machine cannot perform rotate-sorting for this paper size.	The size of paper for which no rotate-sorting is available is selected.	Select the proper paper size. See ⇒ P.55 "Sort".
The machine cannot punch this size of paper.	--	Select the proper paper size that can be used in Punch mode. See ⇒ P.69 "Punch".





Machine Status	Problem/Cause	Action
The number of sheets that can be stapled has been exceeded.	--	Check the stapler capacity. See ⇒ P.60 "Staple".
The machine cannot staple this size of paper.	--	Select the proper paper size that can be used in Staple mode. See ⇒ P.60 "Staple".
This paper is not available in Duplex mode.	A paper size not available in Duplex mode has been selected.	Select a paper size that can be used in Duplex mode. See ⇒ P.111 "Duplex".
You cannot enter the desired copy set number.	The number of copies exceeds the maximum copy quantity.	You can change the maximum copy quantity that you can make at a time. See "Maximum Copy Quantity" in ⇒ P.313 "General Features 2/3"

5

Document Server

Machine Status	Problem/Cause	Action
The machine asks you whether you want to store pages where scanning is finished as 1 file.	The number of scanned pages exceeds the capacity per file of the Document Server.	The maximum number of pages per file you can store is 1,200 pages in the Document Server. To store pages where scanning is finished as 1 file, press the [Yes] key. To cancel scanning, press the [No] key.
Scanned pages became over 1,200 pages per file.	The number of scanned pages exceeds the capacity of the Document Server.	The maximum number of files or pages per file you can store is 200 files or 1,200 pages in the Document Server. Delete any unnecessary files and then scan the document again.

Connect Copy

Machine Status	Problem/Cause	Action
You cannot use Connect Copy.	The sub-unit has a paper misfeed or needs a fresh supply of toner or other replenishable supply.	<p>Press the [Cancel] key on the master unit and follow the instructions given on the sub-unit display.</p> <p> Reference See ⇒ P.268 " Changing the Toner Bottle". See ⇒ P.270 " Clearing Misfeeds". See ⇒ P.293 " Removing Jammed Staples".</p> <p>If the sub-unit display shows that a cover is open, follow the instructions given. For all other situations, follow the instructions on the display.</p>
	The User Tools menu is open on the sub-unit.	Press the [Cancel] key on the master unit. Then on the sub-unit press the [User Tools/Counter] key to close the User Tools menu.
	The sub-unit is busy copying or printing with another function.	Press the [Cancel] key on the master unit then stop the sub-unit from copying/printing.
	The sub-unit is in Interrupt mode.	<p>Press the [Cancel] key on the master unit. Then press the [Interrupt] key on the sub-unit to exit Interrupt mode.</p> <p> Reference ⇒ P.88 "Interrupt Copy"</p>

Machine Status	Problem/Cause	Action
You cannot use Connect Copy.	The sub-unit has been switched off automatically by the Weekly Timer function and is waiting for the Key Operator Off Code to be entered.	Press the [Cancel] key on the master unit. Then on the sub-unit enter the code and press the [#] key. 🔍 Reference See “Key Operator Code for Off Setting” in the System Settings manual.
	The sub-unit is not in Copy mode (i.e., in Document Server mode).	Press the [Cancel] key on the master unit. Then press the [Copy/New Job] key on the sub-unit to switch over to Copy mode.
	The [Connect] key was pressed simultaneously on both the master unit and sub-unit.	Press the [Cancel] key on both the master unit and sub-unit, then press the [Connect] key on just one of them.
	⚠ indicator is lit on the sub-unit.	Follow the instructions shown on the display.
You cannot use Connect Copy. The other machine is in use.	The master unit is not in Copy mode (i.e., in Document Server mode).	Press the [Cancel] key on the master unit. Then press the [Copy/New Job] key on the master unit to switch over to Copy mode.

Document Server



Problem	Action
You forgot your password.	Without the password, you cannot edit or print the document. Scan the document again. You can delete all the saved documents at once with the User Tools. See “Delete All The Saved Files” in ⇒ P.331 “Count Manager” Make sure that no important document is saved in the Document Server before deleting all of the saved documents.



Problem	Action
You cannot find out what is saved in a file.	Check the date or time column in the "Document Server: Files" display.
	Check the contents of the document by printing the first page of it. Press the line for the desired document in the "Document Server: Files" display, and press the [Print 1st Page] key followed by the [Start] key.
Memory becomes full frequently.	Delete any unnecessary files. See ⇒ P.220 "Deleting Saved Documents".
You want to check the print result before making a large print run.	Check the print result by printing out only the first set. See ⇒ P.218 "Sample Printing"
You want to save a document which cannot be deleted automatically.	Turn "Auto File Delete" off, then save the document in the Document Server. See "Auto File Delete" in ⇒ P.331 "Count Manager". If you turn "Auto File Delete" on after saving the document, this function is applied to the next saved documents.

Display



Machine Status	Problem/Cause	Action
The display panel is off.	The screen contrast knob is turned to the dark position.	Set the screen contrast knob to the light position for proper viewing of the display panel.
	The machine is in Energy Saver mode.	Press the [Clear Modes/Energy Saver] key to cancel Energy Saver mode.
	The operation switch is turned off.	Turn on the operation switch.
Nothing happens when the operation switch is turned on.	The main power switch is turned off.	Turn on the main power switch.

Connect Copy



Machine Status	Problem/Cause	Action
The [Connect] key does not appear on the display.	The main power switch on the sub-unit is off.	Turn on the sub-unit main power switch.
	The operation switch on the sub-unit is off.	Press the operation switch on the right side of the control panel. The On indicator will go on.  Note <input type="checkbox"/> The machine will be ready to operate about five minutes after turning power on.
	The master unit is not in Copy mode (i.e., in Document Server mode).	Press the [Copy/New Job] key on the master unit to switch to Copy mode.
	The master unit is in Interrupt mode.	Press the [Interrupt] key on the master unit to exit Interrupt mode.
	The master unit is in Job Preset mode.	Exit Job Preset mode in one of the following ways. ❖ If you are still selecting copy settings and copying has not started yet: Press the [Cancel] key then remove the originals set in the master unit document feeder. ❖ If Job Preset mode is in progress: Press the [Clear/Stop] key, follow the instructions on the display then press the [Cancel] key.  Reference See ⇒ P.83 "Job Preset".





Machine Status	Problem/Cause	Action
The [Connect] key does not appear on the display.	The "Connect Copy Master" of the User Tools setting is "No".	Change the setting to "Yes" or press the [Connect] key on the other unit.  Reference See "Connect Copy Master" in ⇒ P.331 "Count Manager".
	The Connect Copy cable is damaged.	Contact your service representative.
	 indicator is lit.	Follow the instructions shown on the display.
The [Connect] key is grayed out.	The master unit is now copying or copying will start as soon as the warm-up finished.	Press the master unit [Clear/Stop] key to cancel copying.
	Copying has stopped because there is a paper misfeed or toner has run out on the unit you wish to use as the master unit.	Solve the problem on the master unit.
	Functions are programmed that cannot be used with Connect Copy.	Press the master unit [Clear Modes/Energy Saver] key to clear the programmed functions.  Reference ⇒ P.13 "Function List Based on Options"

If Connect Copy Is Cleared

Machine Status	Problem/Cause	Action
Exited Connect Copy.	The master unit main power switch has been turned off or the operation switch has been pressed.	Connect Copy is cancelled and the display returns to copy standby mode. On the master unit, either turn on the main power switch or press the operation switch, then press the [Connect] key and start your copy job again.
	Either the sub-unit main power switch has been turned off or the operation switch has been pressed.	A message requesting you to check the sub-unit is displayed on the master unit. Press the [Cancel] key and clear connect-copying. Either turn on the main power switch on the sub-unit or press the operation switch and then press the [Connect] key.
	The Weekly Timer function has automatically turned the master unit off.	Press the master unit operation switch then press the [Connect] key and copy.  Reference See "Weekly Timer" in the System Settings manual.
An error message indicating a breakdown is shown on the master unit display.	 indicator is lit.	Copying is not possible. Follow the instructions displayed in the error message.

If You Cannot Exit Connect Copy

Machine Status	Problem/Cause	Action
Nothing happens when you press the [Connect] key.	Originals are being scanned or copied.	Press the master unit [Clear/Stop] key and then press the [Cancel] key to cancel scanning or copying.
	There is a paper misfeed in either the master unit or sub-unit.	<p>Clear the paper misfeed in the master unit or sub-unit.</p> <p> Reference</p> <p>⇒ P.270 " Clearing Misfeeds"</p> <p>⇒ P.293 " Removing Jammed Staples"</p> <p>If the display shows that a cover is open, follow the instructions given. For all other situations, follow the instructions on the display.</p> <p>To exit Connect Copy mode, press the master unit [Clear/Stop] key, then press the [Connect] key.</p>
	The master unit [Clear/Stop] key was pressed and scanning of the original has been interrupted.	To exit Connect Copy mode, follow the instructions on the display, then press the [Cancel] key.
	The [Clear/Stop] key was pressed on either the master unit or sub-unit and copying has been interrupted.	To exit Connect Copy mode, follow the instructions on the display, then press the [Cancel] key.



Machine Status	Problem/Cause	Action
<p>Nothing happens when you press the [Connect] key.</p>	<p>The master unit or sub-unit needs a fresh supply of toner or staples.</p>	<p>Solve the problem in the appropriate unit.</p> <p> Reference</p> <ul style="list-style-type: none"> ⇒ P.263 “ Loading Paper” ⇒ P.268 “ Changing the Toner Bottle” ⇒ P.285 “ Adding Staples” ⇒ P.301 “ Removing Punch Waste” <p>For all other situations, follow the instructions on the display.</p> <p>To exit Connect Copy mode, press the master unit [Clear/Stop] key, then press the [Cancel] key.</p>
	<p>A paper misfeed occurred during stapling.</p>	<p>Remove the misfed paper.</p> <p>To exit Connect Copy mode, press the [Clear/Stop] key, then press the [Connect] key.</p>

If You Cannot Make Clear Copies

Problem	Cause	Action
Copies appear dirty.	The image density is too dark.	Adjust the image density. See ⇒ P.40 "Adjusting Copy Image Density".
	Auto Image Density is not selected.	Select Auto Image Density.
The reverse side of an original image is copied.	The image density is too dark.	Adjust the image density. See ⇒ P.40 "Adjusting Copy Image Density".
	Auto Image Density is not selected.	Select Auto Image Density.
A shadow appears on copies if you use pasted originals.	The image density is too dark.	Adjust the image density. See ⇒ P.40 "Adjusting Copy Image Density".
		Change the direction of the original.
		Put mending tape on the pasted part.
The same copy area is dirty whenever making copies.	The exposure glass or document feeder belt is dirty.	Clean them. See ⇒ P.337 "Maintaining Your Machine".
Copies are too light.	The image density is too light.	Adjust the image density. See ⇒ P.40 "Adjusting Copy Image Density".
	Damp or rough grain paper is used.	Use dry paper without rough grain.
	Toner cartridge is almost empty.	Add toner. See ⇒ P.268 "Changing the Toner Bottle".
Parts of the image are not copied.	The original is not set correctly.	Set originals correctly. See ⇒ P.31 "Setting Originals".
	An improper paper size is selected.	Select the proper paper size.
Copies are blank.	The original is not set correctly.	Set originals correctly. See ⇒ P.31 "Setting Originals".
A moiré pattern is produced on copies. 	Your original has a dot pattern image or many lines.	Place the original on the exposure glass at a slight angle.

If You Cannot Make Copies As You Want

General

Problem	Cause	Action
Copies are not stapled.	There are jammed staples in the stapler.	Remove jammed staples. See ⇒ P.293 "  Removing Jammed Staples".  Note <input type="checkbox"/> After removing jammed staples, staples might not be ejected the first few times you try to use the stapler.
	The number of copies exceeds the capacity of the stapler.	Check the stapler capacity. See ⇒ P.60 "Staple".
	Copy paper is curled.	Turn the copy paper over in the tray.
Staples are wrongly positioned.	Originals are not set correctly.	Set originals correctly. See ⇒ P.60 "Staple".
Misfeeds occur frequently.	Copy paper size setting is not correct.	Set the proper paper size. See ⇒ P.282 "Changing the Paper Size".
You cannot combine several functions.	Selected functions cannot be used together.	See ⇒ P.206 "Combination Chart".
When sorting, the pages are divided into two blocks.	The memory became full in the middle of sorting and the pages were ejected in two blocks.	You can interrupt the copying when the memory becomes full. See "Memory Full Auto Scan Restart" in ⇒ P.329 "Input/Output".

Connect Copy

Problem	Cause	Action
Cannot stack, staple or punch.	The optional finisher or punch kit is not installed in the sub-unit.	Press the [Connect] key to exit Connect Copy mode, then copy using stack/staple/punch.

Problem	Cause	Action
The copied images differ.	The "Original Mode Quality Level" of the User Tools settings are not the same.	See "Original Mode Quality Level" in ⇒ P.310 "General Features 1/3".
	The installation of the optional finisher or booklet finisher in both units are not the same.	Press the [Connect] key to exit Connect Copy mode, then start copying.

Adjust Image

Problem	Cause	Action
In Double Copies mode, parts of the original image are not copied.	Combination of original and copy paper is not correct.	Select the proper original and copy paper. See ⇒ P.165 "Double Copies".
In Border, Center, or Center/Border mode, parts of the original image are not copied.	You set the wide erased margin.	Set the narrow margin with the User Tools. See "Erase Border" and "Erase Center" in ⇒ P.317 "Page Format 1/2".
	Your original has narrow margins on four sides.	
In Margin Adjustment mode, parts of the original image are not copied.	You set the wide erased margin.	Set the narrow margin with the User Tools. See "Front Margin: Left/Right" and "Back Margin: Left/Right" in ⇒ P.317 "Page Format 1/2".
In Image Repeat mode, the original image is not copied repeatedly.	You selected the same size copy paper as originals, and did not select the proper reproduction ratio.	Select copy paper larger than the originals.
		Select the proper reproduction ratio.

Combine

Problem	Cause	Action
You cannot make a book from a booklet or magazine by folding copies.	Combine Original Booklet Format or Combine Original Magazine Format is not correct.	Change the setting. See ⇒ P.115 "Combine".

Problem	Cause	Action
Parts of the image are not copied.	You specified an improper reproduction ratio that does not meet the sizes of your originals and copy paper.	When you specify a reproduction ratio using Manual Paper Select mode, make sure that the ratio matches your originals and the copy paper.  Note <input type="checkbox"/> Select the correct reproduction ratio before using Combine mode.
	Your originals are not identical in size and direction.	Use originals that are identical in size and direction.
Order of copies is not correct.	You set originals in the incorrect order.	When setting a stack of originals in the document feeder, the last page should be on the bottom.
		If you set an original on the exposure glass, start with the first page to be copied.

Duplex

Problem	Cause	Action
Order of copies is not correct.	You set originals in the incorrect order.	When setting a stack of originals in the document feeder, the last page should be on the bottom.
		If you set an original on the exposure glass, start with the first page to be copied.

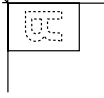
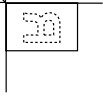
Problem	Cause	Action
Orientation of copies (Top to Top, or Top to Bottom) is not correct.	You set originals in an incorrect direction or the orientation setting is incorrect.	<p>Select the correct orientation, or set originals correctly. See ⇒ P.111 "Duplex".</p> <p> Note</p> <p><input type="checkbox"/> If you set A3, 11" × 17" or B4, 8¹/₂" × 14" originals as shown below, select [Top to Bottom] to make copies in "Top to Top" orientation. Or select [Top to Top] to make copies in "Top to Bottom" orientation.</p> <div style="display: flex; justify-content: space-around; align-items: center;">   </div> <p style="text-align: right; font-size: small;">GP270-A</p>

Stamp

Problem	Cause	Action
The wrong date is printed.	The machine main power has been turned off for more than 20 days.	Set the date correctly again. See "Set Date" in the System Settings manual.
The stamp position is wrong.	The paper orientation is wrong.	Check the paper orientation and stamp position.
The stamp does not appear.	Stamp is too large to print.	Check the size of the user stamp and register it again. See ⇒ P.189 "Program/Delete User Stamp".

When Memory Is Full

Document Server

Machine Status	Action
The memory is full.	Delete any unnecessary files and then scan the document again. See ⇒ P.220 "Deleting Saved Documents".

Connect Copy

Because Connect Copy scans in all your originals into memory, if the number of originals exceeds a certain limit, the machine will run out of memory.

Limitation

- If memory is full on either the master unit or sub-unit, Interrupt Copy will not be available.

Note

- If you set “Memory Full Auto Scan Restart” of the User Tools to “Yes”, the memory overflow message will not be displayed, but make Connect Copy for the scanned original automatically. Connect Copy continues scanning and copying until finishing the job. Note that copy sets will be printed out separately by scanning at this time.

Machine Status	Action
The memory is full.	Press the [Output] key to copy scanned originals and clear the scanning data. Press the [Clear] key to clear the scanning data and not copy.
The machine asks you whether you want to scan the remaining originals.	To continue copying, remove all copies then press the [Resume] key. To stop copying, press the [Cancel] key.

Loading Paper

Note

- ❑ If you want to change the paper size of tray 2 (550-sheet tray), see ⇒ P.282 “Changing the Paper Size”.

Reference

Regarding paper types and sizes, see ⇒ P.23 “Copy Paper”.

Loading Paper in Tray 1 (Tandem Tray)

⚠ CAUTION:

- Take care not to get your hand caught between the right and left trays.

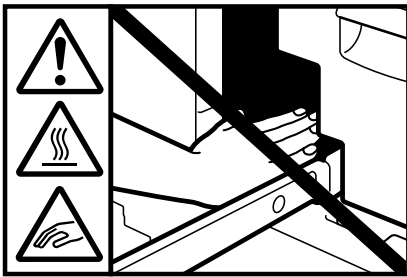

Important

- ❑ When the paper on the right side in tray 1 runs out, the paper on the left side will automatically move to the right side. While the paper on the left side is moving, the machine instructs you to wait. At this time, do not pull out the tray.

Note

- ❑ You can supply paper even while you are making copies using the paper in tray 1. During copying, you can pull out the left half of the tray.
- ❑ Prepare paper of the same size as that loaded in the right of the tray. Load it in the left side in the same direction.

1 Pull out the paper tray until it stops.

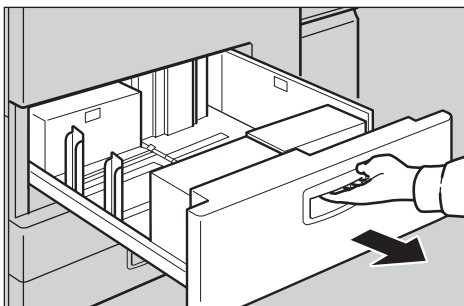

ZBQY010E

2 Square the paper and set it in the tray.

When the whole tray is pulled out

5

1 Set the paper in the right tray.

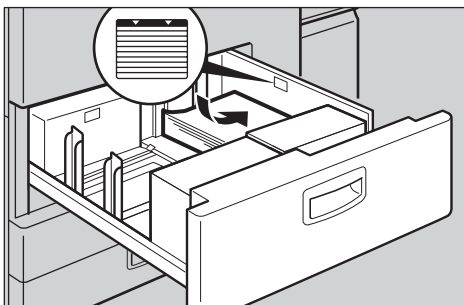

ZBQY020E

2 Return the right tray into the original position.

3 Set the paper in the left tray.

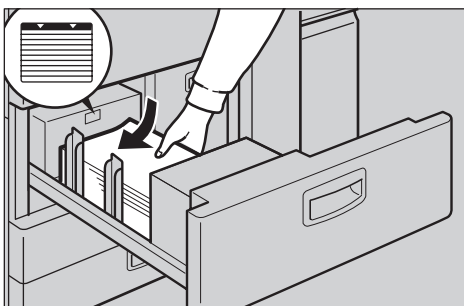

ZBQY030E

Important

- Push the right paper to the right side, and the left paper to the left side.
- Do not stack paper over the limit mark.

When the left half of the tray is pulled out

1 Set the paper in the left tray.

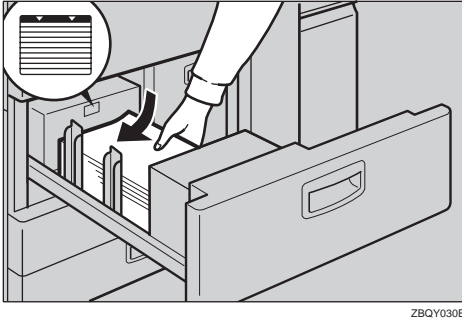

⚠ Important

- Do not stack paper over the limit mark.
- Make sure that the paper stack is flush with the left side fence.

📌 Note

- Straighten the paper, if curled or warped, before placing it in the tray.

3 Push the paper tray in until it stops.

Loading Paper in Tray 2 or 3

1 Pull out the paper tray until it stops.

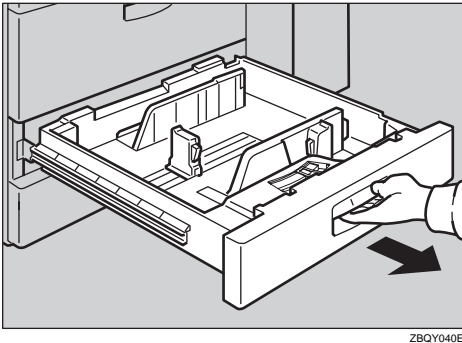

2 Square the paper and set it in the tray.

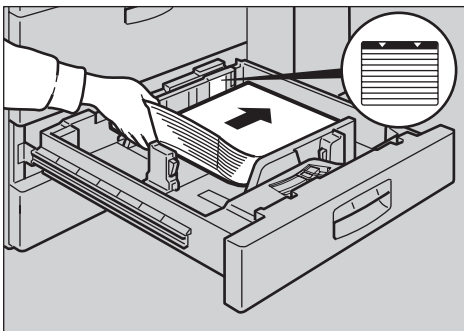

Important

- Do not stack paper over the limit mark.
- Make sure that the paper stack is flush with the right side fence.

Note

- Straighten the paper, if curled or warped, before placing it in the tray.

3 Gently push the paper tray in until it stops.

Loading Paper in the Large Capacity Tray

1 Open the top cover.

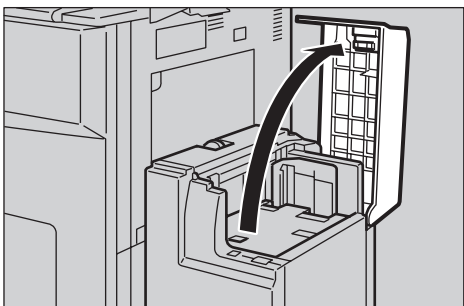

2 Place the paper in the tray along the edge on the left.



 **Note**

- Load up to about 500 sheets of paper in the tray.

3 Press the **[Down]** key.

The key blinks while the bottom plate is moving down.

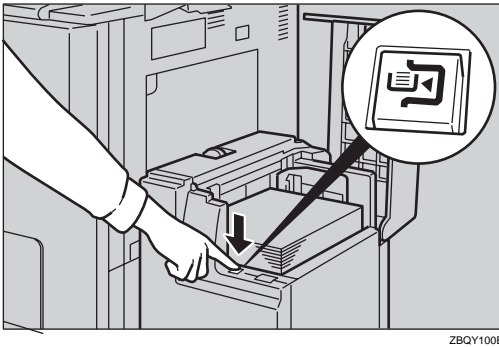

5

4 Load paper by repeating steps **2** and **3**.

 **Note**

- The tray can hold up to 3,500 sheets.

5 Close the top cover.

Changing the Toner Bottle

When  is displayed, it is time to supply toner.

WARNING:

- **Do not incinerate used toner or toner containers. Toner dust might ignite when exposed to an open flame. Dispose of used toner containers in accordance with local regulations for plastics.**

CAUTION:

- Keep toner (used or unused) and toner containers out of reach of children.

CAUTION:

- Our products are engineered to meet high standards of quality and functionality, and we recommend that you only use the expendable supplies available at an authorized dealer.

5

Important

- If you use toner other than that recommended, a fault might occur.
- When adding toner, do not turn off the operation switch. If you do, your settings are cleared.
- Always add toner after the machine instructs you to add toner.
- Do not use used toner. This will damage the machine.

Note

- You can still make about 1,000 copies after  appears, but replace the toner early to prevent poor copy quality.

Reference

Regarding toner storage, see ⇒ P.27 “Toner Storage”.

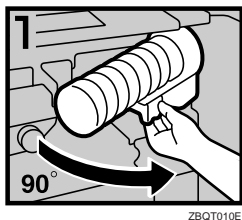

- 1: Open the front cover of the machine.
- 2: Pull out the lever under the toner bottle toward you 90°.

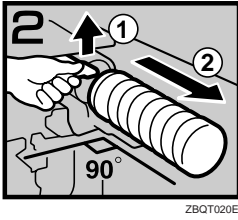

- 3: Pull the green lever, and gently pull out the toner bottle.

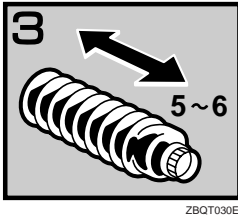

- 4: Hold a new bottle horizontally and shake it 5 or 6 times.

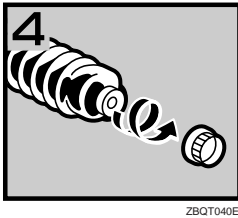

- 5: Remove the outer cap.

Note

- Do not remove the inner cap.

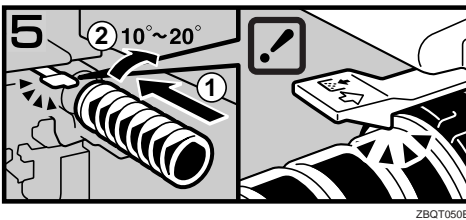

- 6: Place the toner bottle in position, then push it in until the green lever clicks.

Note

- If you cannot get it to click in, pull out the toner bottle a little, slightly rotate it to the right by 10 – 20°, then try again.

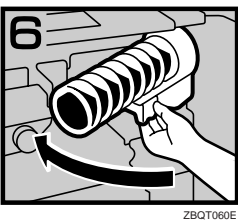

- 7: Return the lever under the toner bottle to its original position.
- 8: Close the front cover of the machine.

Clearing Misfeeds

❖ With 50-Sheet Finisher

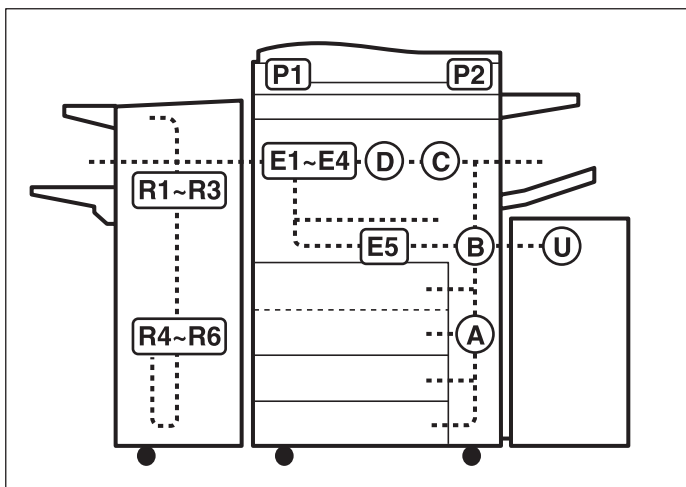

ZBQY110E

❖ With 100-Sheet Finisher

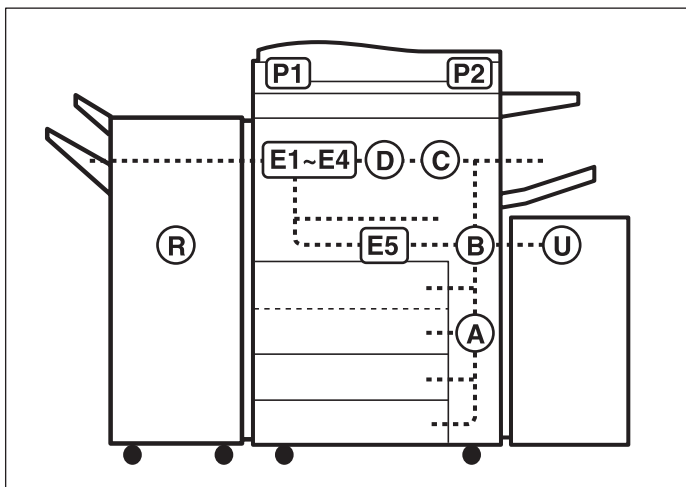

ZBQY180E

◆ With Booklet Finisher

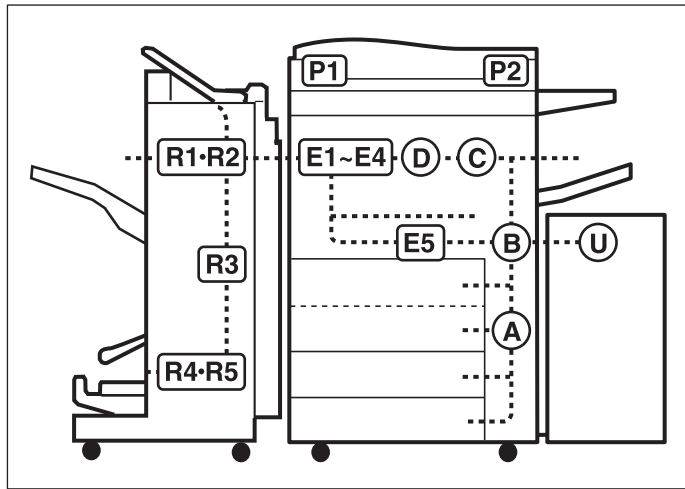

ZBQY190E

⚠ CAUTION:

- The fusing section of this equipment might be very hot. You should be very careful that you don't touch this section when removing the misfed paper.

⚡ Important

- When clearing misfeeds, do not turn off the operation switch. If you do, your copy settings are cleared.
- To prevent misfeeds, do not leave any torn scraps of paper within the machine.
- If paper misfeeds occur repeatedly, contact your service representative.

📝 Note

- More than one misfed area may be indicated. In this case, check every applicable area. See the following charts: A, B, C, D, E1 – E5, P1, P2, U, R (R1 – R6)
- You can find a sticker explaining how to remove misfed paper inside of the front cover or inside of the finisher.

When D is lit

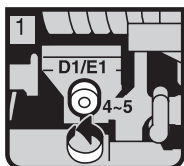

- ① Open the front cover.
- ② Turn fuser unit knob D1/E1 four or five times to eject the paper.

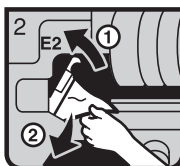

- ③ Raise handle E2 and remove misfed paper.

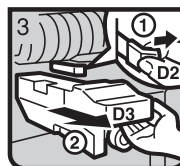

- ④ While pushing lever D2, hold knob D3 and pull out the fuser unit.

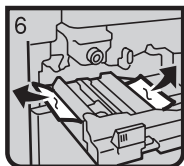

- ⑤ Remove paper if seen.

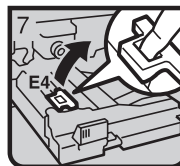

- ⑥ Raise lever E4.

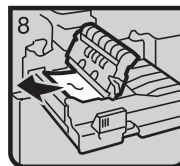

- ⑦ Remove the paper being careful not to touch the area around lever E4.

5

When E₁ – E₄ are lit

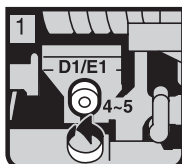

- ① Open the front cover.
- ② Turn fuser unit knob D1/E1 four or five times to eject the paper.

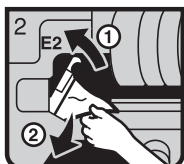

- ③ Raise handle E2 and remove misfed paper.

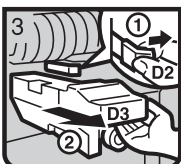

- ④ While pushing lever D2, hold knob D3 and pull out the fuser unit.

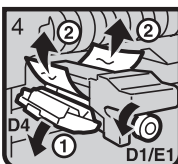

- ⑤ Lower lever D4.
- ⑥ Check to ascertain the left and right-hand sides of the paper, and then grasp the paper and turn knob D1/E1 to remove it.

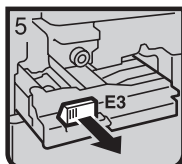

- ⑦ Pull handle E3 and fully pull out the duplex unit.



- ⑧ Remove paper if seen.



- ⑨ Raise lever E4.



- ⑩ Remove the paper being careful not to touch the area around lever E4.



- ⑪ Remove the paper from the output tray if it is visible.
(When the finisher is installed, open the front cover and remove misfed paper.)
- ⑫ Close the front cover.

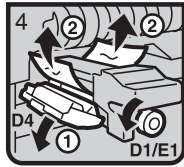

- ④ Lower lever D4.
- ⑤ Check to ascertain the left and right-hand sides of the paper, and then grasp the paper and turn knob D1/E1 to remove it.

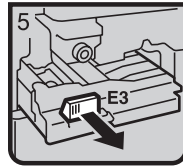

- ⑥ Pull handle E3 and fully pull out the duplex unit.

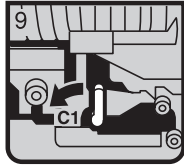

- ⑨ Push lever C1 to the left.

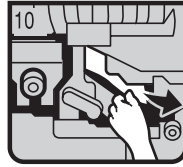

- ⑩ Remove misfed paper.
- ⑪ Return lever C1 to its original position.
- ⑫ Close the front cover.

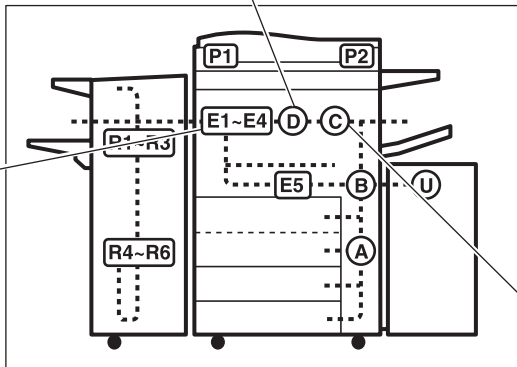

When C is lit

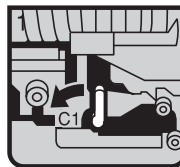

- ① Open the front cover.
- ② Push lever C1 to the left.

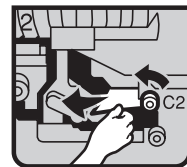

- ③ Turn knob C2 counterclockwise and remove misfed paper.
- ④ Close the front cover.

When E₅ is lit

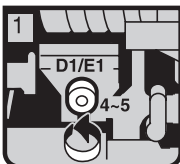

- ① Open the front cover.
- ② Turn fuser unit knob D1/E1 four or five times to eject the paper.

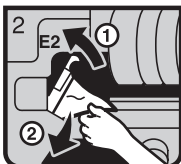

- ③ Raise handle E2 and remove misfed paper.

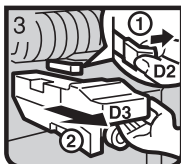

- ④ While pushing lever D2, hold knob D3 and pull out the fuser unit.

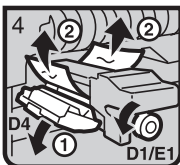

- ⑤ Lower lever D4.
- ⑥ Check to ascertain the left and right-hand sides of the paper, and then grasp the paper and turn knob D1/E1 to remove it.

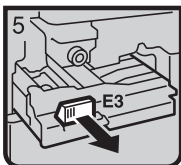

- ⑦ Pull handle E3 and fully pull out the duplex unit.



- ⑧ Remove paper if seen.



- ⑨ Raise lever E4.



- ⑩ Remove the paper being careful not to touch the area around lever E4.

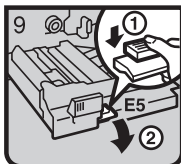

- ⑪ Lower handle E5.

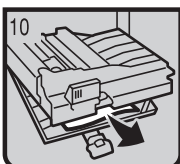

- ⑫ Remove misfed paper.
- ⑬ Return handle E5 to its original position.
- ⑭ Close the cover.

5

When B is lit

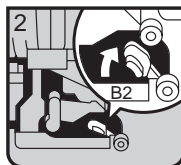
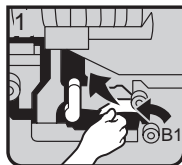

- ① Open the front cover.
- ② Turn knob B1 and remove misfed paper.
- ③ Return lever B2 to its original position.
- ④ Close the front cover.

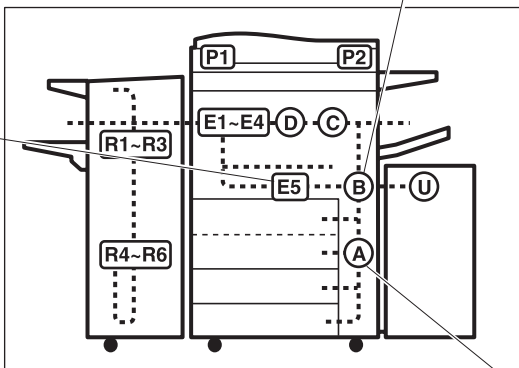

5

When A is lit

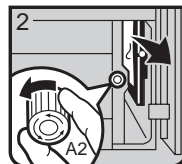
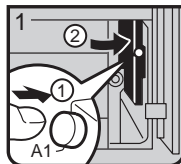

- ① Open the front cover.
- ② Push button A1 and open the guide plate.
- ③ Turn knob A2 and remove misfed paper.
- ④ Close the front cover.

ZBQY210E

When R is lit

50-Sheet Finisher

When R1,R2 or R3 is lit

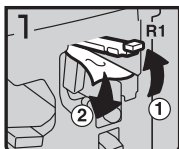

- ① Open the front cover of the machine.
- ② Hold up handle R1 and remove misfed paper.

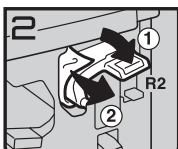

- ③ If you cannot remove misfed paper, hold down handle R2 and remove misfed paper.

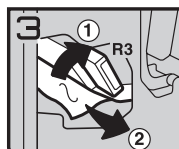

- ④ Hold up handle R3 and remove misfed paper.
- ⑤ Close the front cover of the machine.

When R4,R5 or R6 is lit

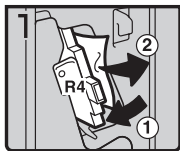

- ① Open the front cover of the machine.
- ② Hold down handle R4 and remove misfed paper.

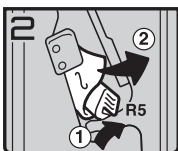

- ③ If you cannot remove misfed paper, hold up handle R5 and remove misfed paper.

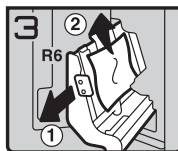

- ④ Pull handle R6 and pull out the staple unit, then remove misfed paper.
- ⑤ Close the front cover of the machine.

When P₁ is lit

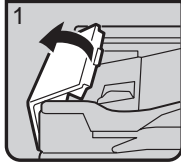

① Open the cover of the auto document feeder (ADF).

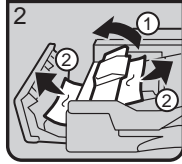

② Remove misfed originals.
③ Close the cover of the auto document feeder (ADF).

When P₂ is lit

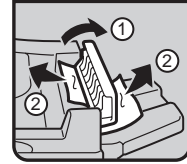

① Open the cover of the auto document feeder (ADF) and remove misfed originals.
② Close the cover of the auto document feeder (ADF).

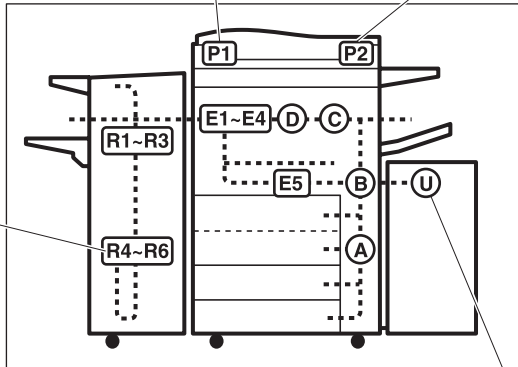

When U is lit

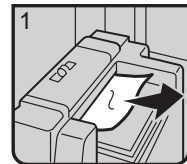

① Open the top cover and remove misfed paper.
② Close the top cover.

When R is lit

100-Sheet Finisher

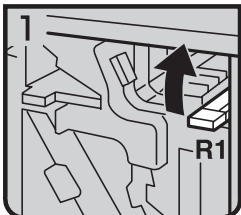

- ① Open the front cover of the machine.
- ② Hold up lever R1 and remove misfed paper.

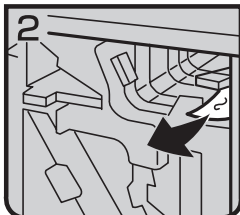

- ③ Remove misfed paper and return lever R1.

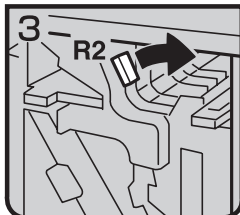

- ④ If you cannot remove misfed paper, hold down lever R2.

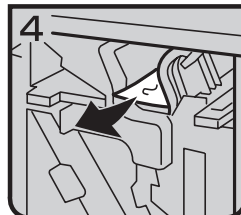

- ⑤ Remove misfed paper and return lever R2.

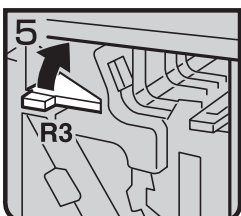

- ⑥ If you can not remove misfed paper, hold up lever R3.

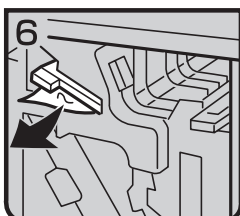

- ⑦ Remove misfed paper and return lever R3.

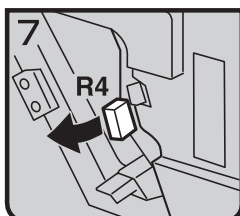

- ⑧ Hold up lever R4.



- ⑨ Remove misfed paper.

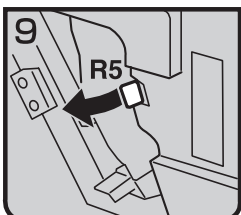

- ⑩ If you can not remove misfed paper, hold up lever R5.

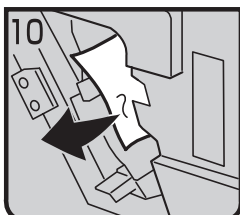

- ⑪ Remove misfed paper.
- ⑫ Return levers R5 and R4 to the original position.

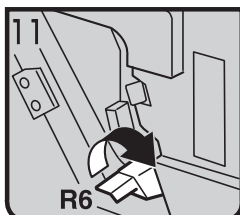

- ⑬ Hold up lever R6.

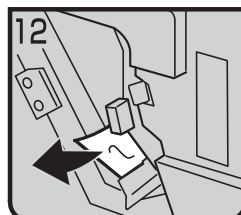

- ⑭ Remove misfed paper.
- ⑮ Return lever R6 to the original position.

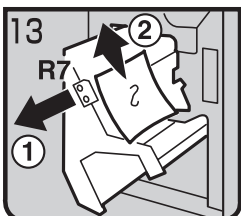

- ⑯ Pull lever R7 and fully pull out the staple unit, then remove misfed paper.
- ⑰ Return Staple unit to original position.
- ⑱ Close the front cover.

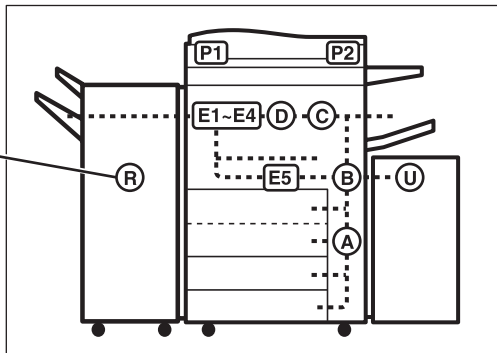

ZBQY240E

When R is lit

Booklet Finisher

When R1 or R2 is lit

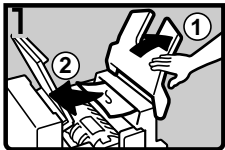

- ① Lift the finisher proof tray, and open the upper cover.
- ② Remove misfed paper.

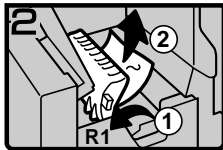

- ③ If you can not remove misfed paper, hold up lever R1 and remove misfed paper.

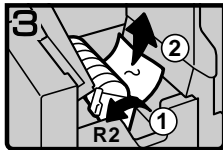

- ④ Hold up lever R2 and remove misfed paper.
- ⑤ Lower the finisher proof tray, and close the upper cover.

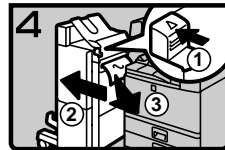

- ⑥ While pushing the release lever, remove the finisher.
- ⑦ Remove misfed paper.
- ⑧ Return the release lever until it clicks, and attach the finisher.

When R3, R4 or R5 is lit

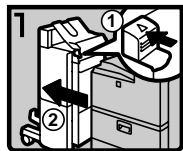

- ① While pushing the release lever, remove the finisher.

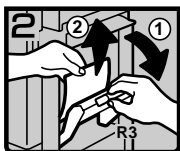

- ② Hold up lever R3 and remove misfed paper.

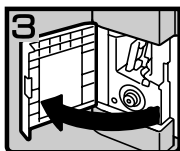

- ③ If you can not remove misfed paper, open the lower front cover.

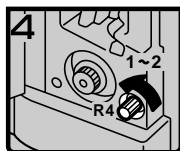

- ④ Turn knob R4 counterclockwise.

Note
Depending on the location of misfed paper, knob R4 might not turn.

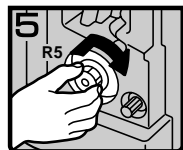

- ⑤ While pushing knob R5, turn knob R5 clockwise.

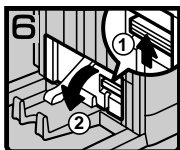

- ⑥ Hold up the lever on the upper right of the booklet tray, and open the cover.

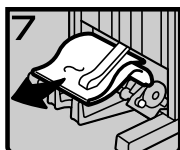

- ⑦ Remove misfed paper.
- ⑧ Close the cover.

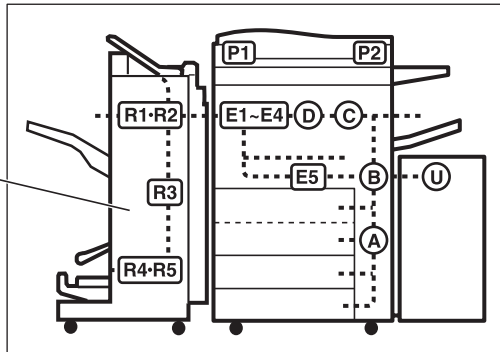

Changing the Paper Size

Important

- ❑ If you wish to change the paper size set in tray 1, tray 3, and the optional large capacity tray (LCT), contact your service representative.

Reference

For paper sizes, weight, and capacity that can be set in each tray, see ⇒ P.23 “Copy Paper”.

Changing the Paper Size in Tray 2

- 1** Make sure that the paper tray (tray 2) is not being used. Then fully pull out the tray.

Remove the paper in the tray.

5

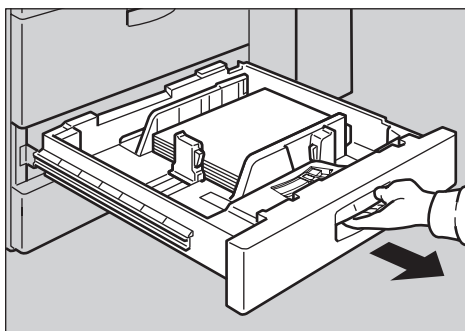

ZBQY140E

- 2** While pushing the release lever, adjust the side fences and back fence to the new paper size.

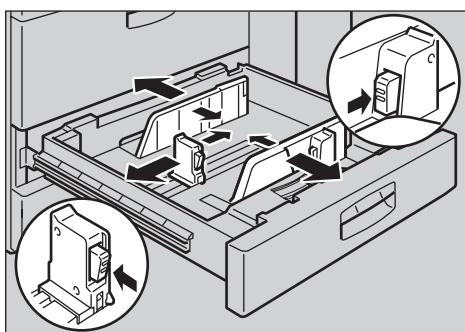

ZBQY150E

3 Square the paper and set it in the tray.

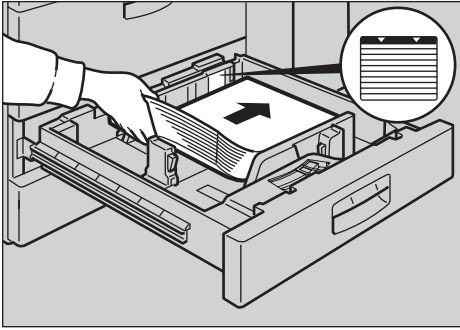

ZBOY050E

⚠ Important

- Do not stack paper over the limit mark.
- Make sure that the paper stack is flush with the right side fence.

📌 Note

- Straighten the paper, if curled or warped, before placing it in the tray.

4 Set the paper size selector inside the tray to the new paper size.



ZBOY160N

To adjust the paper size to one not available with the paper size selector

- 1 Set the paper size selector knob to the * mark on the left.
- 2 Press the [User Tools/Counter] key.
- 3 Press the [System Settings] key.
- 4 Press the [Paper Size Setting] key.
- 5 Press the [Tray 2:Paper Size Setting] key.
- 6 Select your desired size. Then, press the [OK] key.
- 7 Press the [Exit] key or press the [User Tools/Counter] key to exit the User Tools.

 **Important**

- Be sure to select paper size with the User Tools (System Settings). Otherwise, misfeeds might occur.

 **Reference**

For details, see “User Tools (System Settings)” in the System Settings manual.

5 Gently push the paper tray until it stops.

6 Check the paper size displayed on the display panel.

Adding Staples

CAUTION:

- *Our products are engineered to meet high standards of quality and functionality, and we recommend that you only use the expendable supplies available at an authorized dealer.*

Important

- ❑ If you use a staple cartridge other than that recommended, staple failure or staple jams might occur.

Note

- ❑ If the optional booklet finisher is installed, initialize the staple unit for the Saddle Stitch function with the User Tools (System Settings) after adding staples or removing jammed staples. If you do not, misfeeds might occur. See “Staple initialization” in the System Settings manual.

5

50-Sheet Finisher

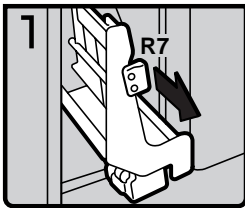

ZBQP510E

- 1: Open the front cover of the finisher.
- 2: Pull out the staple unit.

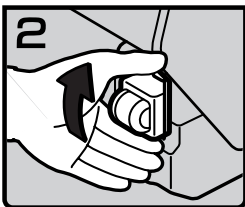

ZBQP520E

- 3: Lift the cartridge until it clicks.

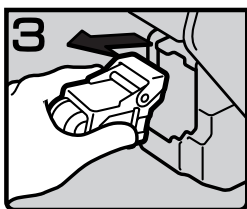

ZBQP530E

- 4: Pull out the cartridge gently.

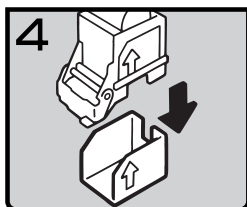

ZBQP540E

- 5: Take out the empty refill in the direction of the arrow.

5

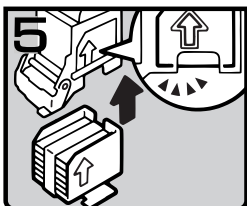

ZBQP550E

- 6: Align the arrows on the new refill and the cartridge, then push in the refill until it clicks.

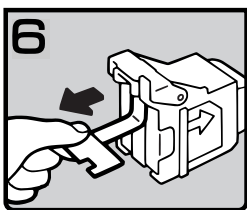

ZBQP560E

- 7: Pull out the ribbon.

- 8: Reinstall the cartridge.

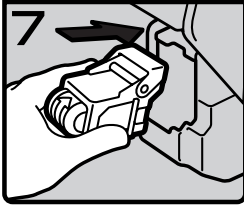

ZBQP570E

- 9: Press down the cartridge until it clicks.

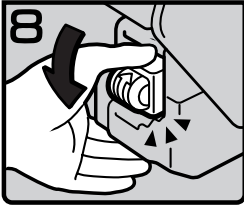

ZBQP580E

- 10: Bring the staple unit back into place.
- 11: Close the front cover of the finisher.

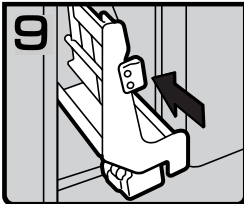

ZBQP590E

5

100-Sheet Finisher

- 1: Open the front cover of the finisher.

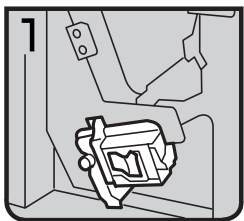

ZBQP200E

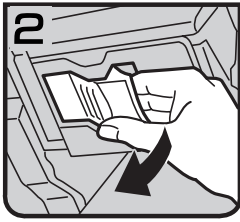

ZBQP210E

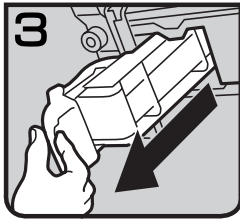

ZBQP220E

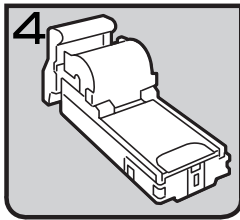

ZBQP230E

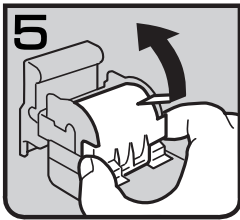

ZBQP240E

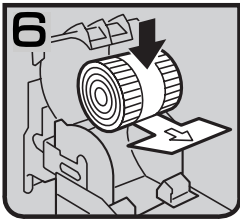

ZBQP250E

- 2: Pull lever R8 down in the staple unit.
- 3: Turn knob R9 until the staple unit rises.
- 4: Pull out the staple unit lever.

- 5: Pull out the staple unit gently.

- 6: Put down the staple unit on a level surface.

- 7: Raise the cover up.

- 8: Set the new refill.

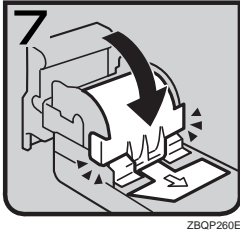

- 9: Lower the cover until it clicks.

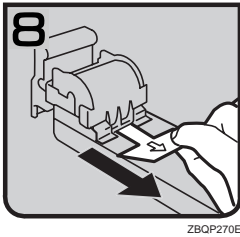

- 10: Pull out the ribbon.

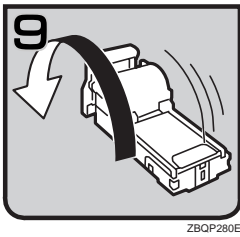

- 11: Turn the staple unit around.

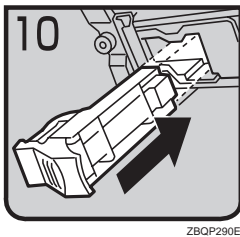

- 12: Reinstall the staple unit.

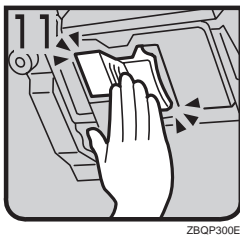

- 13: Push the staple unit until it clicks.

- 14: Close the front cover of the finisher.

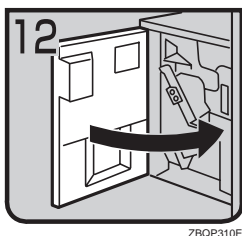

Booklet Finisher

5

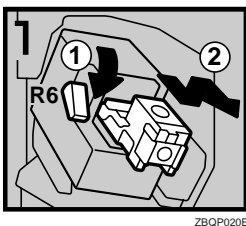

- 1: Open the front cover of the finisher.
- 2: Pull lever R6 down, then pull out the cartridge while lifting the cartridge.

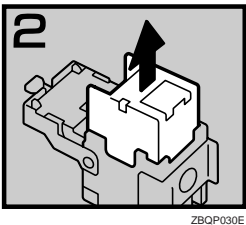

- 3: Take out the empty refill in the direction of the arrow.

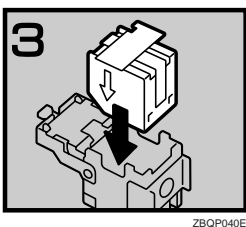

- 4: Set the new refill.

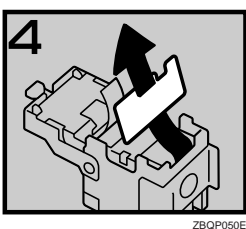

- 5: Pull out the ribbon.

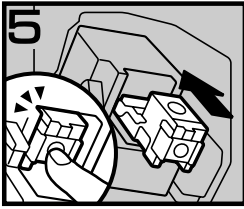

ZBQP060E

- 6: Push the cartridge until it clicks.
- 7: Close the front cover of the finisher.

Staple unit for Saddle Stitch function

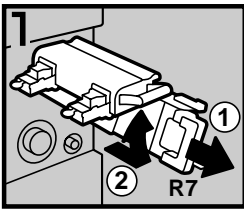

ZBQP070E

- 1: Open the front bottom cover of the finisher.
- 2: Pull lever R7 and fully pull out the staple unit.
- 3: While pulling the lever of the staple unit, lift the lever of the staple unit.

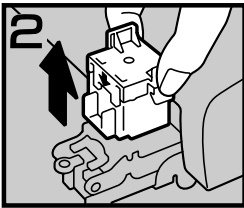

ZBQP080E

- 4: Take out the empty cartridge.

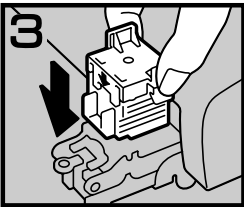

ZBQP090E

- 5: Set the new cartridge.
- 6: Bring the staple unit back into place.
- 7: Close the front bottom cover of the finisher.

To initialize the staple unit with the User Tools (System Settings)

- ➊ Press the **[User Tools/Counter]** key.
- ➋ Press the **[System Settings]** key.
- ➌ Press the **[Staple initialization]** key on the "Basic Page 2" menu.
- ➍ Press the **[OK]** key.

The machine staples a few times without ejecting staples.

- ⑤ Press the [Exit] key and return to the User Tools Main Menu.
- ⑥ Press the [Exit] key and return to Copy mode.

Removing Jammed Staples

Note

- ❑ Staples might be jammed because of curled copies. In this case, try turning the copy paper over in the tray. If there is no improvement, change the copy paper with less curls.
- ❑ After removing jammed staples, staples might not be ejected the first few times you try to use the stapler.
- ❑ If the optional booklet finisher is installed, initialize the staple unit for the Saddle Stitch function with the User Tools (System Settings) after adding staples or removing jammed staples. If you do not, misfeeds might occur. See “Staple initialization” in the System Settings manual.

50-Sheet Finisher

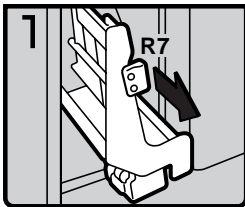

ZBQP610E

- 1: Open the front cover of the finisher.
- 2: Pull out the staple unit.

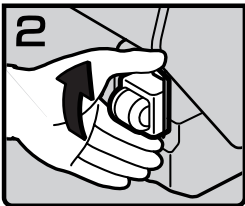

ZBQP620E

- 3: Lift the cartridge until it clicks.

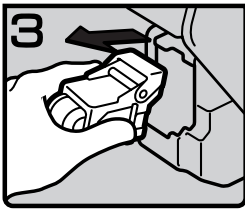

ZBQP630E

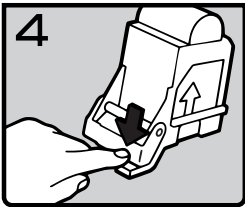

ZBQP640E

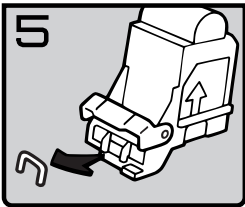

ZBQP650E

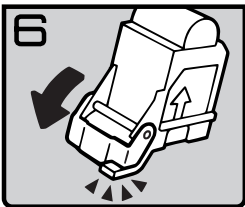

ZBQP660E

- 4: Pull out the cartridge gently.

- 5: Open the face plate by pressing the lock on the right.

- 6: Remove the jammed staples.

- 7: Close the face plate by pressing it until it clicks.

5

- 8: Reinstall the cartridge.

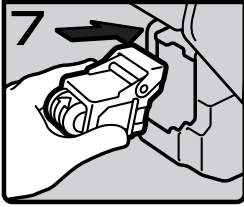

ZBQP670E

- 9: Press down the cartridge until it clicks.

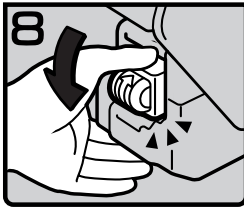

ZBQP680E

- 10: Bring the staple unit back into place.
- 11: Close the front cover of the finisher.

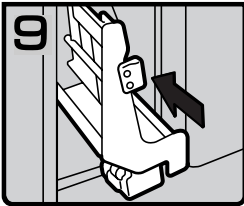

ZBQP690E

5

100-Sheet Finisher

- 1: Open the front cover of the finisher and pull lever R9 down.
- 2: Pull lever R8 and fully pull out the staple unit.

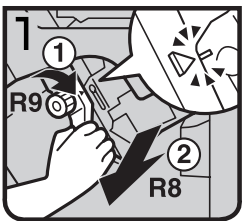

ZBQP320E

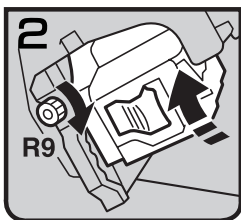

ZBQP330E

- 3: Turn knob R9 until the marks are aligned.

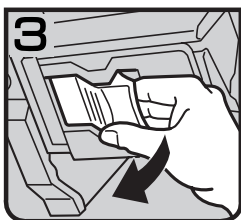

ZBQP340E

- 4: Pull out the staple unit lever.

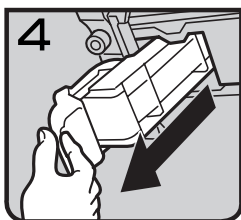

ZBQP350E

- 5: Pull out the staple unit gently.

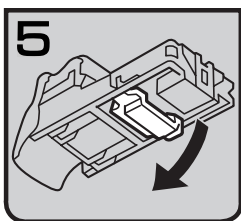

ZBQP360E

- 6: Raise the blue lever.

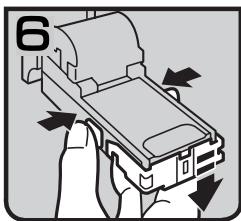

ZBQP370E

- 7: Push the buttons on the both sides of the staple unit and open the face plate.

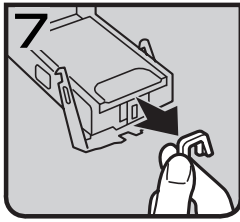

ZBQP390E

- 8: Pull out the jammed staples.

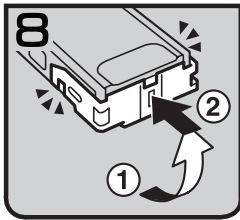

ZBQP390E

- 9: Lower the face plate until it clicks.

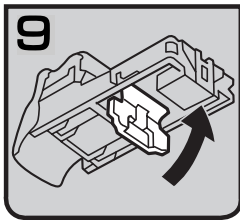

ZBQP400E

- 10: Lower the blue lever.

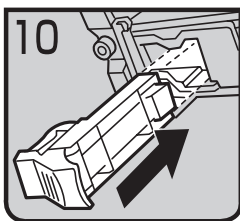

ZBQP410E

- 11: Reinstall the staple unit.

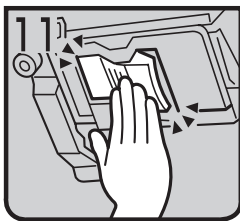

ZBQP420E

- 12: Push the staple unit until it clicks.



ZBQP430E

- 13: Replace the staple unit.
- 14: Close the front cover of the finisher.

Booklet Finisher

5

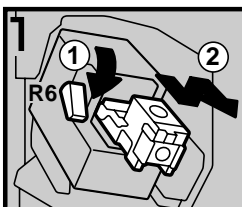

ZBQP100E

- 1: Open the front cover of the finisher.
- 2: Pull lever R6 down, then pull out the cartridge while lifting the cartridge.

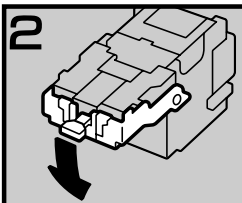

ZBQP110E

- 3: Pull down the knob of the cartridge.

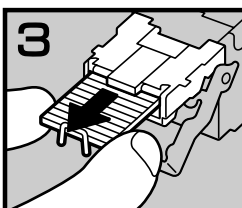

ZBQP120E

- 4: Take out all staples slid from the cartridge.

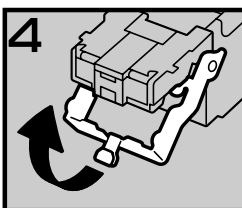

ZBQP130E

- 5: Set the knob of the cartridge back into place.

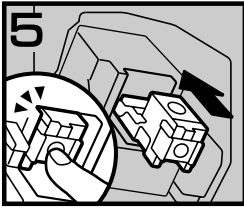

ZBQP140E

- 6: Push the cartridge until it clicks.
- 7: Close the front cover of the finisher.

Staple unit for Saddle Stitch function

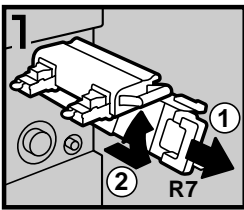

ZBQP150E

- 1: Open the front bottom cover of the finisher.
- 2: Pull lever R7 and fully pull out the staple unit.
- 3: While pulling the lever of the staple unit, lift the lever of the staple unit.

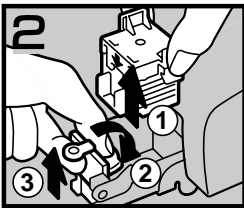

ZBQP160E

- 4: Take out the cartridge.
- 5: Pull the blue knob down, then lift the knob of the face plate.

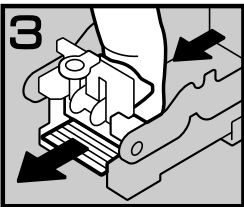

ZBQP170E

- 6: Remove all jammed staples.

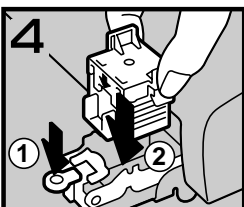

ZBQP180E

- 7: Bring the face plate back into place by pushing it.
- 8: Push the cartridge.
- 9: Bring the staple unit back into place, then close the front bottom cover of the finisher.

To initialize the staple unit with the User Tools (System Settings)

- ❶ Press the **[User Tools/Counter]** key.
- ❷ Press the **[System Settings]** key.
- ❸ Press the **[Staple initialization]** key on the “Basic Page 2” menu.
- ❹ Press the **[OK]** key.
The machine staples a few times without ejecting staples.
- ❺ Press the **[Exit]** key and return to the **User Tools Main Menu**.
- ❻ Press the **[Exit]** key and return to **Copy mode**.

Removing Punch Waste

Note

- While "Hole Punch Receptacle Full." is displayed, you cannot use the Punch function.

50-Sheet Finisher

- 1 Open the front cover of the finisher.

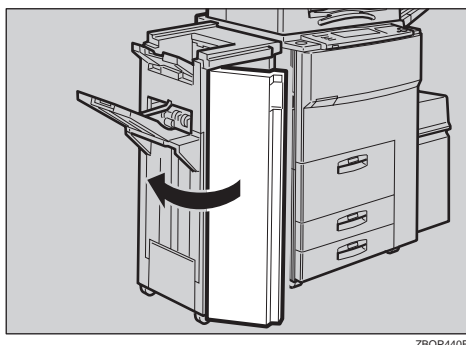

5

- 2 Pull out the punch waste box and remove punch waste.

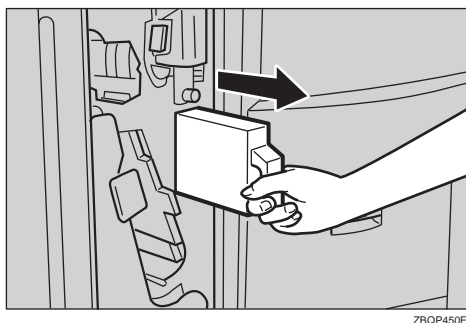

- 3 Reinstall the punch waste box.

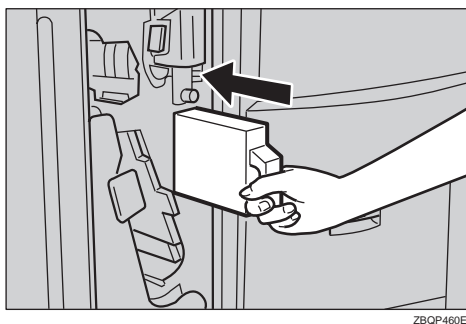

 **Note**

- If you do not, “Hole Punch Receptacle Full.” is still displayed.

4 Close the front cover of the finisher.

“Hole Punch Receptacle Full.” disappears.

 **Note**

- If the message is still displayed, reinstall the punch waste box.

100-Sheet Finisher

1 Open the front cover of the finisher.

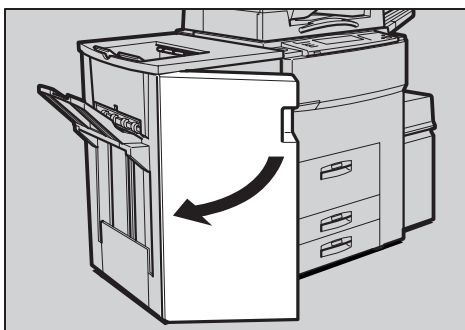

ZBQP470E

2 Pull out the punch waste box and remove punch waste.

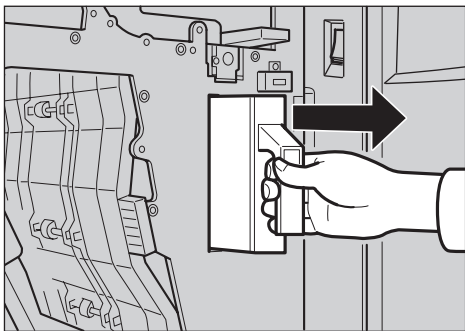

ZBQP480E

3 Reinstall the punch waste box.

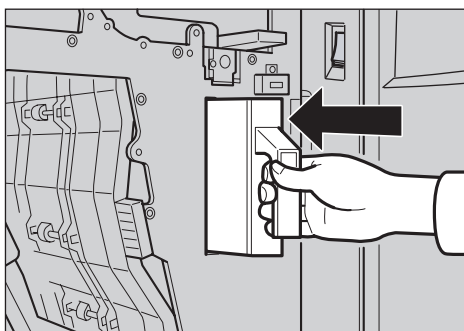

ZBQP490E

Note

- If you do not, “Hole Punch Receptacle Full.” is still displayed.

4 Close the front cover of the finisher.

“Hole Punch Receptacle Full.” disappears.

Note

- If the message is still displayed, reinstall the punch waste box.

6. User Tools (Copy/Document Server Features)

Accessing the User Tools (Copy/Document Server Features)

This section is for the key operators in charge of this machine. You can change or set the machine's default settings.

Preparation

After using the User Tools, be sure to exit from the User Tools.

The selected key is highlighted.

Any changes you make with the User Tools remain in effect even if the main power switch or operation switch is turned off, or the **[Clear Modes/Energy Saver]** key is pressed.

Reference

For details, see “Accessing the User Tools (System Settings)” in the System Settings manual.

1 Press the **[User Tools/Counter]** key.

The User Tools Main Menu appears.

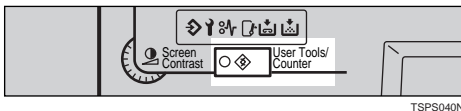

2 Press the **[Copy/Document Server Features]** key.

The Copy /Document Server Features menu appears.

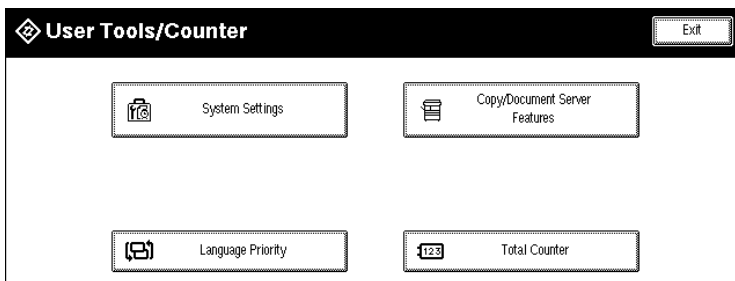

3 Select the desired menu and press the key.

Note

- [▼Next]: Press to go to the next page.
- [▲Prev.]: Press to go back to the previous page.

Reference

⇒ P.308 "User Tools Menu (Copy/Document Server Features)".

4 Change the settings by following the instructions on the display panel. Then press the [OK] key.

Reference

⇒ P.310 "Settings You Can Change with the User Tools".

Note

- [OK]: Press to set the new settings and return to the previous menu.
- [Cancel]: Press to return to the previous menu without changing any data.

Exiting From the User Tools

1 After changing the User Tools settings, press the [Exit] key on the User Tools Main Menu.

Changing the User Tools is completed, and the machine is ready for copying.

Note

- To exit from the change of the machine's default settings and return to Copy mode, press the **[User Tools/Counter]** key.
- You can also exit from the User Tools by pressing the **[User Tools/Counter]** key.

This page is intentionally blank.

User Tools Menu (Copy/Document Server Features)

General Features

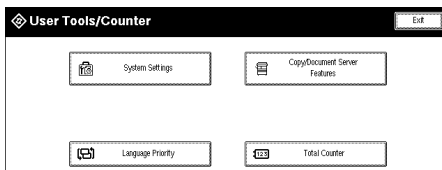
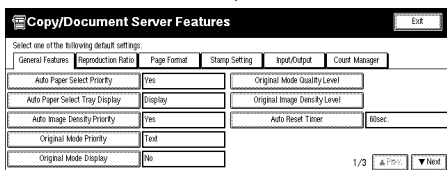

▲ Prev. Key ▼ Next Key

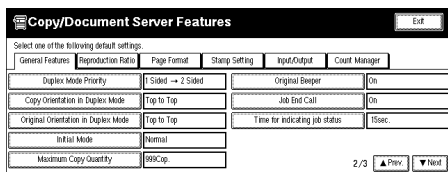

▲ Prev. Key ▼ Next Key

Page Format

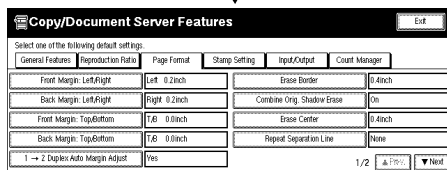

▲ Prev. Key ▼ Next Key

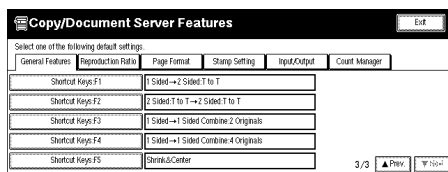

▲ Prev. Key ▼ Next Key

Reproduction Ratio

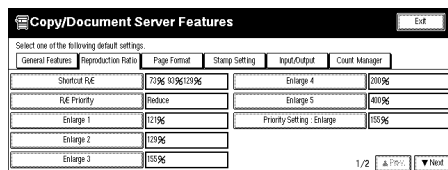

▲ Prev. Key ▼ Next Key

Page Numbering

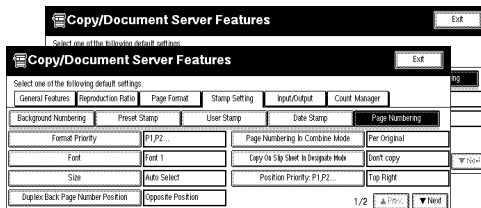

▲ Prev. Key

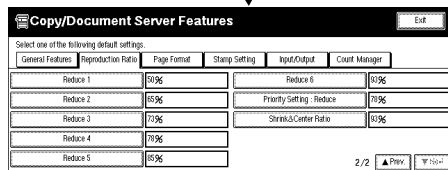

▲ Prev. Key ▼ Next Key

Date Stamp

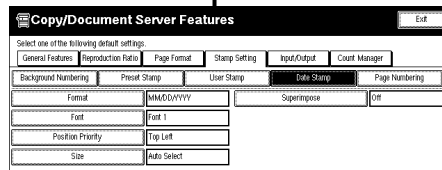

▲ Prev. Key

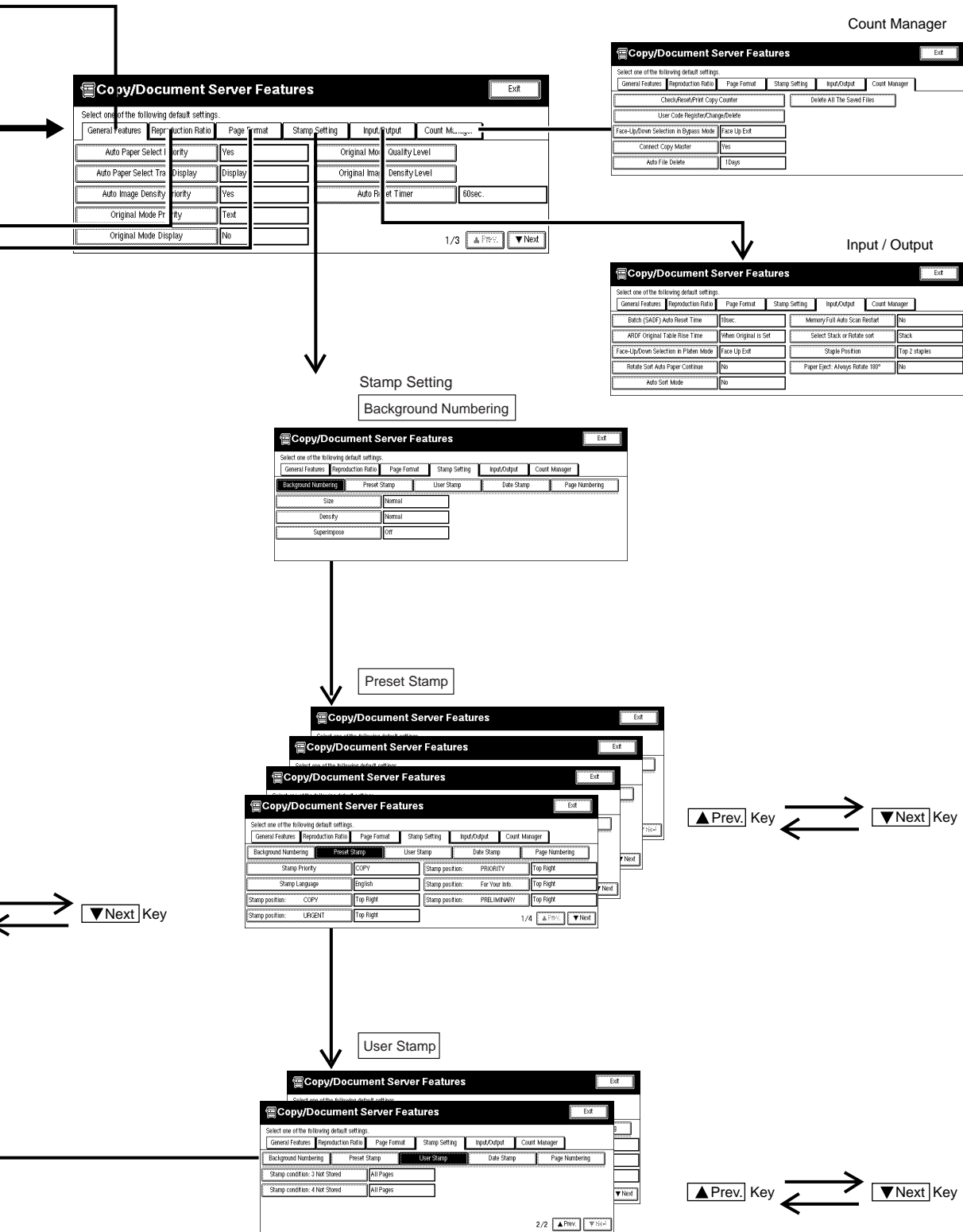









Settings You Can Change with the User Tools

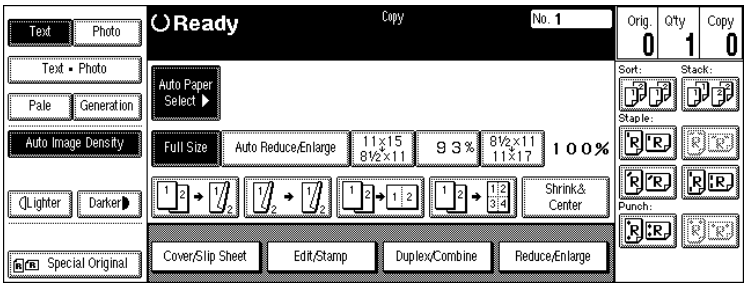

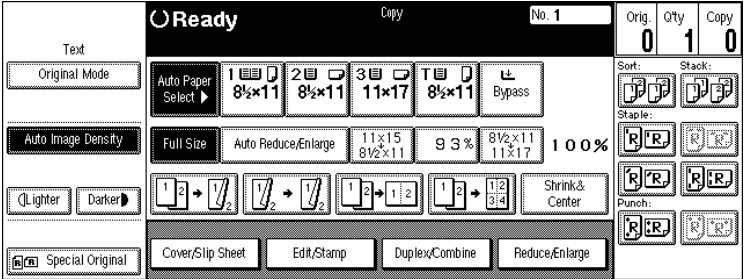
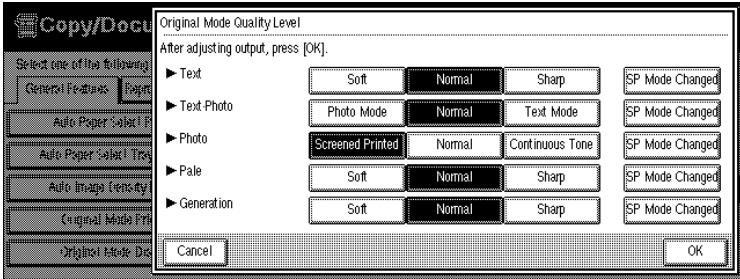

 **Reference**

For how to access the User Tools, see ⇒ P.305 “Accessing the User Tools (Copy/Document Server Features)”.







General Features 1/3



Menu	Description
Auto Paper Select Priority	As a default setting, Auto Paper Select is selected. You can cancel this setting.  Note <input type="checkbox"/> Default: <i>Yes</i>
Auto Paper Select Tray Display	You can choose whether the available paper trays/sizes are shown on the initial display.  Note <input type="checkbox"/> Default: <i>Display</i> <input type="checkbox"/> If you choose “Hide”, the display is shown as below. When the [Auto Paper Select] key is pressed, paper sizes appear on the display. <div data-bbox="458 1093 1199 1373" style="border: 1px solid black; padding: 5px; margin: 10px 0;">  </div>
Auto Image Density Priority	As a default setting, Auto Image Density is selected. You can change this setting.  Note <input type="checkbox"/> Default: <i>Yes</i>
Original Mode Priority	As a default setting, Text is selected as the Originals Type. You can change it to Text:Photo, Photo, Pale, or Generation.  Note <input type="checkbox"/> Default: <i>Text</i>

Menu	Description
Original Mode Display	<p>You can choose whether the original modes are shown on the initial display.</p> <p> Note</p> <ul style="list-style-type: none"> <input type="checkbox"/> Default: <i>No</i> <input type="checkbox"/> If you choose “Yes”, the display is shown as below. 
Original Mode Quality Level	<p>You can adjust the quality level of copies for each of the original types (Text, Text-Photo, Photo, Pale, Generation).</p> 
Text	<p>Adjust the sharpness of text.</p> <p> Note</p> <ul style="list-style-type: none"> <input type="checkbox"/> Default: <i>Normal</i> <input type="checkbox"/> [SP Mode Changed] is the value set during service setup. <input type="checkbox"/> Choosing [Sharp] or [Soft] affects the outline sharpness of text.
Text-Photo	<p>When there are photo(s) and text on the original, determine whether the photo or text takes priority.</p> <p> Note</p> <ul style="list-style-type: none"> <input type="checkbox"/> Default: <i>Normal</i> <input type="checkbox"/> [SP Mode Changed] is the value set during service setup. <input type="checkbox"/> [Normal] achieves a good balance between text and photos.

Menu	Description
Photo	<p>For a photo original, adjust the finish quality level to match the type of photo original.</p> <p> Note</p> <ul style="list-style-type: none"> <input type="checkbox"/> Default: <i>Screened Printed</i> <input type="checkbox"/> [SP Mode Changed] is the value set during service setup. <input type="checkbox"/> Select [Screened Printed] for printed photo originals, and [Continuous Tone] for printed photo originals with fine dots. <input type="checkbox"/> Select [Normal] for printed photo and text originals.
Pale	<p>Adjust the quality level for the finish of a pale original with normal density.</p> <p> Note</p> <ul style="list-style-type: none"> <input type="checkbox"/> Default: <i>Normal</i> <input type="checkbox"/> [SP Mode Changed] is the value set during service setup.
Generation	<p>Adjust the quality level so as not to thicken the lines of the finish image.</p> <p> Note</p> <ul style="list-style-type: none"> <input type="checkbox"/> Default: <i>Normal</i> <input type="checkbox"/> [SP Mode Changed] is the value set during service setup.
Original Image Density Level	<p>You can select one of seven original image density levels for each of the original types (Text, Text-Photo, Photo, Pale, Generation).</p> <p> Note</p> <ul style="list-style-type: none"> <input type="checkbox"/> Default: <i>Normal</i>
Auto Reset Timer	<p>The machine returns to its initial condition automatically after your job is finished. The time can be set from 10 to 999 seconds, or 0.</p> <p> Note</p> <ul style="list-style-type: none"> <input type="checkbox"/> Default: <i>60sec.</i> <input type="checkbox"/> To turn "Auto Reset Timer" off, input "0". <input type="checkbox"/> Note that when "Auto Reset Timer" is turned off, the machine will not return to the user code input window automatically.

General Features ²/₃



Menu	Description
Duplex Mode Priority	<p>You can select the type of the Duplex function effective when the machine is turned on, Energy Saver mode is off, or Auto Reset is on.</p> <p> Note</p> <p><input type="checkbox"/> Default:</p> <ul style="list-style-type: none"> • Metric version: <i>1 Sided</i> → <i>1 Sided</i> • Inch version: <i>1 Sided</i> → <i>2 Sided</i>
Copy Orientation in Duplex Mode	<p>You can set the copy orientation when making two-sided copies.</p> <p> Note</p> <p><input type="checkbox"/> Default: <i>Top to Top</i></p>
Original Orientation in Duplex Mode	<p>You can set the original orientation when making two-sided copies.</p> <p> Note</p> <p><input type="checkbox"/> Default: <i>Top to Top</i></p>
Initial Mode	<p>You can select the initial mode or Program No. 10 as the mode effective when the machine is turned on, or modes are cleared.</p> <p> Note</p> <p><input type="checkbox"/> Default: <i>Normal</i></p>
Maximum Copy Quantity	<p>The maximum copy quantity can be set between 1 and 999.</p> <p> Note</p> <p><input type="checkbox"/> Default: <i>999Cop.</i></p>
Original Beeper	<p>The beeper (key tone) sounds when you forgot to remove originals after copying.</p> <p> Note</p> <p><input type="checkbox"/> Default: <i>On</i></p> <p><input type="checkbox"/> If the “Operation Panel Beeper” of the User Tools (System Settings) setting is “Off”, the beeper does not sound irrespective of the “Original Beeper” setting. See “Operation Panel Beeper” in the System Settings manual.</p>

Menu	Description
Job End Call	<p>You can choose whether or not the beeper sounds when copying is complete, when copying is interrupted, when the paper tray runs out of paper, or when there is a paper jam.</p> <p> Note</p> <ul style="list-style-type: none"> <input type="checkbox"/> Default: <i>On</i> <input type="checkbox"/> When the “Auto Response (Human) Sensor” of the User Tools (System Settings) setting is set to “Yes” and the machine senses that there is a person present, it judges that copying operations are not complete and the beeper does not sound. See “Auto Response (Human) Sensor” in the System Settings manual. <input type="checkbox"/> If the “Operation Panel Beeper” of the User Tools (System Settings) setting is “Off”, the beeper does not sound irrespective of the “Job End Call” setting. See “Operation Panel Beeper” in the System Settings manual.
Time for indicating job status	<p>The machine returns to its initial condition automatically from the Job List display. The time can be set from 10 to 999 seconds, or 0.</p> <p> Note</p> <ul style="list-style-type: none"> <input type="checkbox"/> Default: <i>15sec.</i> <input type="checkbox"/> To turn “Time for indicating job status” off, input “0”.

General Features ³/₃



Menu	Description
Shortcut Keys:F1 Shortcut Keys:F2 Shortcut Keys:F3 Shortcut Keys:F4 Shortcut Keys:F5	<p>You can register frequently used functions in Shortcut Keys F1 to F5. You can also change the registered functions. See ⇒ P.10 “Display Panel”.</p> <p> Note</p> <ul style="list-style-type: none"> <input type="checkbox"/> Default: <ul style="list-style-type: none"> • Shortcut Keys:F1: <i>1 Sided</i>→<i>2 Sided:T to T</i> • Shortcut Keys:F2: <i>2 Sided:T to T</i>→<i>2 Sided:T to T</i> • Shortcut Keys:F3: <i>1 Sided</i>→<i>1 Sided Combine:2 Originals</i> • Shortcut Keys:F4: <i>1 Sided</i>→<i>1 Sided Combine:4 Originals</i> • Shortcut Keys:F5: <i>Shrink&Center</i> <input type="checkbox"/> By using the Copy Face Up function, you can have copies delivered in reverse order specified by “Face-Up/Down Selection in Platen Mode” of the User Tools. However, you cannot combine the Copy Face Up function with the Staple/Punch function. If you select the bypass tray in which tab stocks are loaded, the “Copy Face Up” setting is ignored.

Reproduction Ratio $1/2$

Menu	Description
Shortcut R/E	<p>You can register up to three frequently used Reduce/Enlarge ratios other than the fixed Reduce/Enlarge ratio and have them shown on the initial display. You can also change the registered Reduce/Enlarge ratios.</p> <p>If no Reduce/Enlarge ratio has been set when selecting [User Ratio 1], [User Ratio 2], or [User Ratio 3], enter the desired Reduce/Enlarge ratio using the number keys.</p>
R/E Priority	<p>Specify which Reduce, Enlarge or Input Ratio is shown on the display panel with priority when the [Reduce/Enlarge] key is pressed.</p> <p> Note</p> <p><input type="checkbox"/> Default: <i>Reduce</i></p>
Enlarge 1 Enlarge 2 Enlarge 3 Enlarge 4 Enlarge 5	<p>You can customize the enlargement ratios available when you press the [Reduce/Enlarge] key followed by the [Enlarge] key.</p> <p> Note</p> <p><input type="checkbox"/> Default:</p> <ul style="list-style-type: none"> • Metric version: <ul style="list-style-type: none"> • Enlarge 1: 115% • Enlarge 2: 122% • Enlarge 3: 141% • Enlarge 4: 200% • Enlarge 5: 400% • Inch version: <ul style="list-style-type: none"> • Enlarge 1: 121% • Enlarge 2: 129% • Enlarge 3: 155% • Enlarge 4: 200% • Enlarge 5: 400% <p><input type="checkbox"/> When selecting [User Set. Ratio], enter a ratio using the number keys (in the range of 101 to 400%).</p>





Menu	Description
Priority Setting : Enlarge	<p>You can set the ratio with priority when the [Reduce/Enlarge] key is pressed, followed by the [Enlarge] key.</p> <p> Note</p> <p><input type="checkbox"/> Default:</p> <ul style="list-style-type: none"> • Metric version: 141% • Inch version: 155%





Reproduction Ratio $2/2$







Menu	Description
Reduce 1 Reduce 2 Reduce 3 Reduce 4 Reduce 5 Reduce 6	<p>You can customize the reduction ratios available when you press the [Reduce/Enlarge] key followed by the [Reduce] key.</p> <p> Note</p> <p><input type="checkbox"/> Default:</p> <ul style="list-style-type: none"> • Metric version: <ul style="list-style-type: none"> • Reduce 1: 50% • Reduce 2: 65% • Reduce 3: 71% • Reduce 4: 75% • Reduce 5: 82% • Reduce 6: 93% • Inch version: <ul style="list-style-type: none"> • Reduce 1: 50% • Reduce 2: 65% • Reduce 3: 73% • Reduce 4: 78% • Reduce 5: 85% • Reduce 6: 93% <p><input type="checkbox"/> When selecting [User Reduc.Ratio], enter a ratio using the number keys (in the range of 25 to 99%).</p>
Priority Setting : Reduce	<p>You can set the ratio with priority when the [Reduce/Enlarge] key is pressed, followed by the [Reduce] key.</p> <p> Note</p> <p><input type="checkbox"/> Default:</p> <ul style="list-style-type: none"> • Metric version: 75% • Inch version: 78%

Menu	Description
Shrink&Center Ratio	<p>You can set a Reduce/Enlarge ratio when registering “Shrink&Center” in a Shortcut Key.</p> <p> Note</p> <p><input type="checkbox"/> Default: 93%</p>





Page Format ¹/₂









Menu	Description
Front Margin: Left/Right	<p>You can specify left and right margins on the front side of copies in Margin Adjust mode.</p> <p> Note</p> <p><input type="checkbox"/> Default:</p> <ul style="list-style-type: none"> • Metric version: <i>Left 5mm</i> • Inch version: <i>Left 0.2"</i>
Back Margin: Left/Right	<p>You can specify left and right margins on the back side of copies in Margin Adjust mode.</p> <p> Note</p> <p><input type="checkbox"/> Default:</p> <ul style="list-style-type: none"> • Metric version: <i>Right 5mm</i> • Inch version: <i>Right 0.2"</i>
Front Margin: Top/Bottom	<p>You can specify front top and bottom margins on the front side of copies in Margin Adjust mode.</p> <p> Note</p> <p><input type="checkbox"/> Default:</p> <ul style="list-style-type: none"> • Metric version: <i>Bottom 0mm</i> • Inch version: <i>Bottom 0.0"</i>
Back Margin: Top/Bottom	<p>You can specify back top and bottom margins on the front side of copies in Margin Adjust mode.</p> <p> Note</p> <p><input type="checkbox"/> Default:</p> <ul style="list-style-type: none"> • Metric version: <i>Bottom 0mm</i> • Inch version: <i>Bottom 0.0"</i>



Menu	Description
1 → 2 Duplex Auto Margin Adjust	<p>In 1 sided →2 sided Duplex mode, you can specify whether to automatically set the margins on the back side.</p> <p>The margin is set to the same value of “Back Margin: Left/Right”.</p> <p> Note</p> <p><input type="checkbox"/> Default: <i>Yes</i></p>
Erase Border	<p>The default setting of the width of the erased margins in Erase Border mode can be changed as follows:</p> <ul style="list-style-type: none"> • Metric version: 3 – 50mm in 1mm steps • Inch version: 0.1" – 2.0" in 0.1" steps <p> Note</p> <p><input type="checkbox"/> Default:</p> <ul style="list-style-type: none"> • Metric version: <i>10mm</i> • Inch version: <i>0.4"</i>
Combine Orig. Shadow Erase	<p>In Combine Copy or Booklet/Magazine Copy mode, you can specify whether to erase a 3mm, 0.1" bounding margin around all four edges of each original.</p> <p> Note</p> <p><input type="checkbox"/> Default: <i>On</i></p>
Erase Center	<p>The default setting of the width of the erased margins in Erase Center mode can be changed as follows:</p> <ul style="list-style-type: none"> • Metric version: 3 – 50mm in 1mm steps • Inch version: 0.1" – 2.0" in 0.1" steps <p> Note</p> <p><input type="checkbox"/> Default:</p> <ul style="list-style-type: none"> • Metric version: <i>10mm</i> • Inch version: <i>0.4"</i>

Menu	Description
Repeat Separation Line	<p>You can select a separation line in Image Repeat mode from no line, Solid line, Broken line 1, Broken line 2, or Crop.</p> <ul style="list-style-type: none"> • None  • Solid  • Broken 1  • Broken 2  • Crop  <p> Note <input type="checkbox"/> Default: <i>None</i></p>

Page Format ²/₂



Menu	Description
Double Copies Separation Line	<p>You can select a separation line in Double Copy mode from no line, Solid line, Broken line, or Crop.</p> <ul style="list-style-type: none">• None • Solid • Broken • Crop Marks  <p> Note <input type="checkbox"/> Default: <i>None</i></p>

Menu	Description
Combine Separation Line	<p>You can select a separation line in Combine mode from no line, Solid line, Broken line 1, Broken line 2, or Crop.</p> <ul style="list-style-type: none"> • None  • Solid  • Broken 1  • Broken 2  • Crop  <p> Note <input type="checkbox"/> Default: <i>None</i></p>
Copy Back Cover	<p>When copying the back cover, you can specify whether to issue the back cover outside (outside page) or inside (inside page).</p> <p> Note <input type="checkbox"/> Default: <i>Outside (Reverse)</i></p>
Cover page in combine mode	<p>You can specify whether to make a combined copy on the front cover sheet when you select [Copy] in Front Cover mode.</p> <p> Note <input type="checkbox"/> Default: <i>Combine</i></p>
Designated Slip Sheet Copy In Combine	<p>You can specify whether to make a combined copy on the inserted slip sheets in Designate: Copy mode.</p> <p> Note <input type="checkbox"/> Default: <i>Combine</i></p>



Menu	Description																																																																																															
Booklet/Magazine Original Orientation	<p>You can select the type of originals for Booklet or Magazine mode.</p> <p> Note</p> <p><input type="checkbox"/> Default: <i>Portrait</i></p>																																																																																															
Copy Order In Combine Mode	<p>You can set the copy order in Combine mode to “Left to Right” or “Top to Bottom”.</p> <table border="1" data-bbox="463 483 960 1232"> <thead> <tr> <th></th> <th>Top to Top</th> <th>Top to Bottom</th> </tr> </thead> <tbody> <tr> <td>Combine 1 Side 1 Sided 4 originals</td> <td> <table border="1"> <tr><td>1</td><td>2</td></tr> <tr><td>3</td><td>4</td></tr> </table> </td> <td> <table border="1"> <tr><td>1</td><td>3</td></tr> <tr><td>2</td><td>4</td></tr> </table> </td> </tr> <tr> <td>Combine 1 Side 1 Sided 8 originals</td> <td> <table border="1"> <tr><td>1</td><td>2</td><td>3</td><td>4</td></tr> <tr><td>5</td><td>6</td><td>7</td><td>8</td></tr> </table> </td> <td> <table border="1"> <tr><td>1</td><td>3</td><td>5</td><td>7</td></tr> <tr><td>2</td><td>4</td><td>6</td><td>8</td></tr> </table> </td> </tr> <tr> <td>Combine 2 Side 1 Sided 8 originals</td> <td> <table border="1"> <tr> <td>Front</td> <td>Back</td> </tr> <tr><td>1</td><td>5</td></tr> <tr><td>2</td><td>6</td></tr> <tr><td>3</td><td>7</td></tr> <tr><td>4</td><td>8</td></tr> </table> </td> <td> <table border="1"> <tr> <td>Front</td> <td>Back</td> </tr> <tr><td>1</td><td>5</td></tr> <tr><td>3</td><td>7</td></tr> <tr><td>2</td><td>6</td></tr> <tr><td>4</td><td>8</td></tr> </table> </td> </tr> <tr> <td>Combine 2 Side 1 Sided 16 originals</td> <td> <table border="1"> <tr> <td>Front</td> <td>Back</td> </tr> <tr><td>1</td><td>9</td></tr> <tr><td>2</td><td>10</td></tr> <tr><td>3</td><td>11</td></tr> <tr><td>4</td><td>12</td></tr> <tr><td>5</td><td>13</td></tr> <tr><td>6</td><td>14</td></tr> <tr><td>7</td><td>15</td></tr> <tr><td>8</td><td>16</td></tr> </table> </td> <td> <table border="1"> <tr> <td>Front</td> <td>Back</td> </tr> <tr><td>1</td><td>9</td></tr> <tr><td>3</td><td>11</td></tr> <tr><td>5</td><td>13</td></tr> <tr><td>7</td><td>15</td></tr> <tr><td>2</td><td>10</td></tr> <tr><td>4</td><td>12</td></tr> <tr><td>6</td><td>14</td></tr> <tr><td>8</td><td>16</td></tr> </table> </td> </tr> </tbody> </table> <p style="text-align: right; font-size: small;">GCCOMBOE</p> <p> Note</p> <p><input type="checkbox"/> Default: <i>Left to Right</i></p>		Top to Top	Top to Bottom	Combine 1 Side 1 Sided 4 originals	<table border="1"> <tr><td>1</td><td>2</td></tr> <tr><td>3</td><td>4</td></tr> </table>	1	2	3	4	<table border="1"> <tr><td>1</td><td>3</td></tr> <tr><td>2</td><td>4</td></tr> </table>	1	3	2	4	Combine 1 Side 1 Sided 8 originals	<table border="1"> <tr><td>1</td><td>2</td><td>3</td><td>4</td></tr> <tr><td>5</td><td>6</td><td>7</td><td>8</td></tr> </table>	1	2	3	4	5	6	7	8	<table border="1"> <tr><td>1</td><td>3</td><td>5</td><td>7</td></tr> <tr><td>2</td><td>4</td><td>6</td><td>8</td></tr> </table>	1	3	5	7	2	4	6	8	Combine 2 Side 1 Sided 8 originals	<table border="1"> <tr> <td>Front</td> <td>Back</td> </tr> <tr><td>1</td><td>5</td></tr> <tr><td>2</td><td>6</td></tr> <tr><td>3</td><td>7</td></tr> <tr><td>4</td><td>8</td></tr> </table>	Front	Back	1	5	2	6	3	7	4	8	<table border="1"> <tr> <td>Front</td> <td>Back</td> </tr> <tr><td>1</td><td>5</td></tr> <tr><td>3</td><td>7</td></tr> <tr><td>2</td><td>6</td></tr> <tr><td>4</td><td>8</td></tr> </table>	Front	Back	1	5	3	7	2	6	4	8	Combine 2 Side 1 Sided 16 originals	<table border="1"> <tr> <td>Front</td> <td>Back</td> </tr> <tr><td>1</td><td>9</td></tr> <tr><td>2</td><td>10</td></tr> <tr><td>3</td><td>11</td></tr> <tr><td>4</td><td>12</td></tr> <tr><td>5</td><td>13</td></tr> <tr><td>6</td><td>14</td></tr> <tr><td>7</td><td>15</td></tr> <tr><td>8</td><td>16</td></tr> </table>	Front	Back	1	9	2	10	3	11	4	12	5	13	6	14	7	15	8	16	<table border="1"> <tr> <td>Front</td> <td>Back</td> </tr> <tr><td>1</td><td>9</td></tr> <tr><td>3</td><td>11</td></tr> <tr><td>5</td><td>13</td></tr> <tr><td>7</td><td>15</td></tr> <tr><td>2</td><td>10</td></tr> <tr><td>4</td><td>12</td></tr> <tr><td>6</td><td>14</td></tr> <tr><td>8</td><td>16</td></tr> </table>	Front	Back	1	9	3	11	5	13	7	15	2	10	4	12	6	14	8	16
	Top to Top	Top to Bottom																																																																																														
Combine 1 Side 1 Sided 4 originals	<table border="1"> <tr><td>1</td><td>2</td></tr> <tr><td>3</td><td>4</td></tr> </table>	1	2	3	4	<table border="1"> <tr><td>1</td><td>3</td></tr> <tr><td>2</td><td>4</td></tr> </table>	1	3	2	4																																																																																						
1	2																																																																																															
3	4																																																																																															
1	3																																																																																															
2	4																																																																																															
Combine 1 Side 1 Sided 8 originals	<table border="1"> <tr><td>1</td><td>2</td><td>3</td><td>4</td></tr> <tr><td>5</td><td>6</td><td>7</td><td>8</td></tr> </table>	1	2	3	4	5	6	7	8	<table border="1"> <tr><td>1</td><td>3</td><td>5</td><td>7</td></tr> <tr><td>2</td><td>4</td><td>6</td><td>8</td></tr> </table>	1	3	5	7	2	4	6	8																																																																														
1	2	3	4																																																																																													
5	6	7	8																																																																																													
1	3	5	7																																																																																													
2	4	6	8																																																																																													
Combine 2 Side 1 Sided 8 originals	<table border="1"> <tr> <td>Front</td> <td>Back</td> </tr> <tr><td>1</td><td>5</td></tr> <tr><td>2</td><td>6</td></tr> <tr><td>3</td><td>7</td></tr> <tr><td>4</td><td>8</td></tr> </table>	Front	Back	1	5	2	6	3	7	4	8	<table border="1"> <tr> <td>Front</td> <td>Back</td> </tr> <tr><td>1</td><td>5</td></tr> <tr><td>3</td><td>7</td></tr> <tr><td>2</td><td>6</td></tr> <tr><td>4</td><td>8</td></tr> </table>	Front	Back	1	5	3	7	2	6	4	8																																																																										
Front	Back																																																																																															
1	5																																																																																															
2	6																																																																																															
3	7																																																																																															
4	8																																																																																															
Front	Back																																																																																															
1	5																																																																																															
3	7																																																																																															
2	6																																																																																															
4	8																																																																																															
Combine 2 Side 1 Sided 16 originals	<table border="1"> <tr> <td>Front</td> <td>Back</td> </tr> <tr><td>1</td><td>9</td></tr> <tr><td>2</td><td>10</td></tr> <tr><td>3</td><td>11</td></tr> <tr><td>4</td><td>12</td></tr> <tr><td>5</td><td>13</td></tr> <tr><td>6</td><td>14</td></tr> <tr><td>7</td><td>15</td></tr> <tr><td>8</td><td>16</td></tr> </table>	Front	Back	1	9	2	10	3	11	4	12	5	13	6	14	7	15	8	16	<table border="1"> <tr> <td>Front</td> <td>Back</td> </tr> <tr><td>1</td><td>9</td></tr> <tr><td>3</td><td>11</td></tr> <tr><td>5</td><td>13</td></tr> <tr><td>7</td><td>15</td></tr> <tr><td>2</td><td>10</td></tr> <tr><td>4</td><td>12</td></tr> <tr><td>6</td><td>14</td></tr> <tr><td>8</td><td>16</td></tr> </table>	Front	Back	1	9	3	11	5	13	7	15	2	10	4	12	6	14	8	16																																																										
Front	Back																																																																																															
1	9																																																																																															
2	10																																																																																															
3	11																																																																																															
4	12																																																																																															
5	13																																																																																															
6	14																																																																																															
7	15																																																																																															
8	16																																																																																															
Front	Back																																																																																															
1	9																																																																																															
3	11																																																																																															
5	13																																																																																															
7	15																																																																																															
2	10																																																																																															
4	12																																																																																															
6	14																																																																																															
8	16																																																																																															





Stamp Setting

Background Numbering



Menu	Description
Size	<p>You can set the size of the numbers.</p> <p> Note</p> <p><input type="checkbox"/> Default: <i>Normal</i></p> <ul style="list-style-type: none"> • Small: About 8 × 4mm, 0.32" × 0.16" • Normal: About 32 × 16mm, 1.28" × 0.64" • Large: About 64 × 32mm, 2.56" × 1.28"
Density	<p>You can set the density of the numbers.</p> <p> Note</p> <p><input type="checkbox"/> Default: <i>Normal</i></p>
Superimpose	<p>You can select whether the numbering is printed negative when it overlaps black parts of the image.</p> <p> Note</p> <p><input type="checkbox"/> Default: <i>Off</i></p>

Preset Stamp

Menu	Description
Stamp Priority	<p>You can select the stamp type priority detected in Stamp mode.</p> <p> Note</p> <p><input type="checkbox"/> Default: <i>COPY</i></p>
Stamp Language	<p>You can select the language of the message that is printed in Stamp mode.</p> <p> Note</p> <p><input type="checkbox"/> Default: <i>English</i></p>





Menu	Description
Stamp position	<p>You can set the position at which the stamp is printed. Press the arrow keys to adjust the position.</p> <p> Note</p> <p><input type="checkbox"/> Default:</p> <ul style="list-style-type: none"> • Metric Version: <ul style="list-style-type: none"> • Position: <i>Top Right</i> • Top/Bottom Margin: <i>24mm</i> • Left/Right Margin: <i>24mm</i> • Inch Version: <ul style="list-style-type: none"> • Position: <i>Top Right</i> • Top/Bottom Margin: <i>0.9"</i> • Left/Right Margin: <i>0.9"</i>
<p>Stamp condition</p> <p>You can adjust the size, density and print page for the stamp.</p>	
Size	<p>You can set the size of the stamp.</p> <p> Note</p> <p><input type="checkbox"/> Default: <i>1X</i></p>
Density	<p>You can set the pattern used to print the stamp.</p> <p> Note</p> <p><input type="checkbox"/> Default: <i>Normal</i></p> <p><input type="checkbox"/> Normal: The stamp is printed on the image. You cannot confirm which parts overlap the image.</p> <p><input type="checkbox"/> Lighter: The image can be seen through the stamp.</p> <p><input type="checkbox"/> Light: You can see the image even clearer than in the "Lighter" setting.</p>
Print Page	<p>You can select whether the stamp is printed on the first page or all pages.</p> <p> Note</p> <p><input type="checkbox"/> Default: <i>All Pages</i></p>
Superimpose	<p>You can select whether the Preset Stamp is printed negative when it overlaps black parts of the image.</p> <p> Note</p> <p><input type="checkbox"/> Default: <i>Off</i></p>

User Stamp

Menu	Description
Program/Delete Stamp	<p>You can register up to 4 custom stamps with your favorite design. You can register/change/delete your favorite design as a user stamp.</p> <p>How to Program/Delete Stamp, see ⇒ P.189 “Program/Delete User Stamp”.</p>
Stamp position	<p>You can set the position at which the stamp is printed. Press the arrow keys to adjust the position.</p> <p> Note</p> <p><input type="checkbox"/> Default:</p> <ul style="list-style-type: none"> • Metric version: <ul style="list-style-type: none"> • Position: <i>Top Right</i> • Top/Bottom Margin: <i>24mm</i> • Left/Right Margin: <i>24mm</i> • Inch version: <ul style="list-style-type: none"> • Position: <i>Top Right</i> • Top/Bottom Margin: <i>0.9"</i> • Left/Right Margin: <i>0.9"</i>
Stamp condition	<p>You can adjust the print page for User Stamp 1 to 4 you registered.</p>
Print Page	<p>You can select whether the stamp is printed on the first page or all pages.</p> <p> Note</p> <p><input type="checkbox"/> Default: <i>All Pages</i></p>







Date Stamp

Menu	Description
Format	<p>You can select the date format for Date Stamp mode.</p> <p> Note</p> <p><input type="checkbox"/> Default:</p> <ul style="list-style-type: none"> • Metric version: <i>DD/MM/YYYY</i> • Inch version: <i>MM/DD/YYYY</i>

Menu	Description
Font	<p>You can select the Date Stamp font.</p> <p> Note</p> <p><input type="checkbox"/> Default: <i>Font 1</i></p> <p><input type="checkbox"/> This setting is linked with Page Numbering.</p>
Position Priority	<p>You can set the position at which the stamp is printed. Press the arrow keys to adjust the position.</p> <p> Note</p> <p><input type="checkbox"/> Default:</p> <ul style="list-style-type: none"> • Metric version: <ul style="list-style-type: none"> • Position: <i>Top Left</i> • Top/Bottom Margin: <i>8mm</i> • Left/Right Margin: <i>32mm</i> • Inch version: <ul style="list-style-type: none"> • Position: <i>Top Left</i> • Top/Bottom Margin: <i>0.3"</i> • Left/Right Margin: <i>0.8"</i>
Size	<p>You can set the Date Stamp size.</p> <p> Note</p> <p><input type="checkbox"/> Default: <i>Auto Select</i></p> <p><input type="checkbox"/> This setting is linked with Page Numbering.</p>
Superimpose	<p>You can select whether the Date Stamp is printed negative when it overlaps black parts of the image.</p> <p> Note</p> <p><input type="checkbox"/> Default: <i>Off</i></p> <p><input type="checkbox"/> This setting is linked with Page Numbering.</p>





Page Numbering





Menu	Description
Format Priority	<p>You can select the page number format priority detected in Page Numbering mode.</p> <p> Note</p> <p><input type="checkbox"/> Default: <i>P1, P2</i></p>

Menu	Description
Font	<p>You can select the font of the page number that is printed in Page Numbering mode.</p> <p> Note</p> <p><input type="checkbox"/> Default: <i>Font 1</i></p> <p><input type="checkbox"/> This setting is linked with Date Stamp.</p>
Size	<p>You can set the size of the stamp that is printed in Page Numbering mode.</p> <p> Note</p> <p><input type="checkbox"/> Default: <i>Auto Select</i></p> <p><input type="checkbox"/> This setting is linked with Date Stamp.</p>
Duplex Back Page Number Position	<p>You can set the position of the duplex back page number that is printed in Duplex mode.</p> <p> Note</p> <p><input type="checkbox"/> Default: <i>Opposite Position</i></p>
Page Numbering In Combine Mode	<p>You can set how the pages are numbered when you use the Combine function and Page Numbering function together.</p> <p> Note</p> <p><input type="checkbox"/> Default: <i>Per Original</i></p>
Copy On Slip Sheet In Designate Mode	<p>You can select whether to print the page number onto slip sheets when you use the Designate function set to “Copy” and Page Numbering function together.</p> <p> Note</p> <p><input type="checkbox"/> Default: <i>Don't copy</i></p>
Position Priority: P1, P2... Position Priority: 1/5, 2/5... Position Priority: -1-, -2- ... Position Priority: P.1, P.2... Position Priority: 1, 2... Position Priority: 1-1, 1-2...	<p>You can set the position at which the stamp is printed. Press the arrow keys to adjust the position.</p> <p> Note</p> <p><input type="checkbox"/> Default:</p> <ul style="list-style-type: none"> • Metric version: <ul style="list-style-type: none"> • Position: P1, 1/5, P.1, 1: <i>Top Right</i>, -1-, 1-1: <i>Bottom Center</i> • Top/Bottom Margin: P1, 1/5, P.1, 1: <i>12mm</i>, -1-, 1-1: <i>8mm</i> • Left/Right Margin: P1, 1/5, P.1, 1: <i>12mm</i>, -1-, 1-1: <i>0mm</i> • Inch version: <ul style="list-style-type: none"> • Position: P1, 1/5, P.1, 1: <i>Top Right</i>, -1-, 1-1: <i>Bottom Center</i> • Top/Bottom Margin: P1, 1/5, P.1, 1: <i>0.5"</i>, -1-, 1-1: <i>0.3"</i> • Left/Right Margin: P1, 1/5, P.1, 1: <i>0.5"</i>, -1-, 1-1: <i>0.0"</i>

Menu	Description
Superimpose	<p>You can select whether page numbers are printed negative when they overlap black parts of the image.</p> <p> Note</p> <ul style="list-style-type: none"><input type="checkbox"/> Default: <i>Off</i><input type="checkbox"/> This setting is linked with Date Stamp.



Input/Output





Menu	Description
Batch (SADF) Auto Re-set Time	<p>When you set one original at a time in the document feeder, the Auto Feed indicator lights for a selected time after an original is fed to show that the document feeder is ready for another original. You can adjust this time from 3 seconds to 99.</p> <p> Note <input type="checkbox"/> Default: <i>10sec.</i></p>
ARDF Original Table Rise Time	<p>You can set the document feeder original table rise time.</p> <p> Note <input type="checkbox"/> Default: <i>When Original is Set</i></p>
Face-Up/Down Selection in Platen Mode	<p>When copying an original placed on the exposure glass or loaded in the document feeder, you can specify which way it is ejected.</p> <p> Note <input type="checkbox"/> Default: <i>Face Up Exit</i></p>
Rotate Sort Auto Paper Continue	<p>You can specify whether to continue copying when the paper of the required orientation has run out during rotate-sorting. See "Rotate Sort" in ⇒ P.55 "Sort".</p> <ul style="list-style-type: none"> • If you select [No]: When paper of the required orientation runs out, the machine stops copying and prompts you to supply copy paper. When you load paper, the machine will continue copying. • If you select [Yes]: Copying continues using copy paper of a different direction. The copy job will finish even if you have left the machine. <p> Note <input type="checkbox"/> Default: <i>No</i></p>

Menu	Description
Auto Sort Mode	<p>You can specify whether Sort mode is selected when the machine is turned on or the mode is cleared.</p> <p> Note</p> <p><input type="checkbox"/> Default: <i>No</i></p>
Memory Full Auto Scan Restart	<p>When the memory becomes full while scanning originals, the machine can make copies of the scanned originals first, then automatically proceed scanning the remaining originals.</p> <p>You can enable or disable this function.</p> <ul style="list-style-type: none"> • If you select [Yes]: When the memory becomes full, the machine stops operation allowing you to remove the copy pages delivered on the output tray. • If you select [No]: You can leave the machine unattended to make all the copies, but the resulting sorted pages will not be sequential. <p> Note</p> <p><input type="checkbox"/> Default: <i>No</i></p>
Select Stack or Rotate sort	<p>Specify which Stack or Rotate Sort is shown on the initial display with priority.</p> <p> Note</p> <p><input type="checkbox"/> Default: <i>Stack</i></p> <p><input type="checkbox"/> The optional finisher or booklet finisher is required to use this function.</p>
Staple Position	<p>Specify which Top 2 staples or Bottom is shown on the initial display with priority.</p> <p> Note</p> <p><input type="checkbox"/> Default: <i>Top 2 staples</i></p> <p><input type="checkbox"/> The optional finisher or booklet finisher is required to use this function.</p>
Paper Eject: Always Rotate 180°	<p>If you want to copy on the paper with letterhead, the machine rotates the image correctly. To use this function, select "Yes".</p> <p> Note</p> <p><input type="checkbox"/> Default: <i>No</i></p>

Count Manager

When a key operator code has already been entered, you cannot begin manager settings unless you enter the key operator code (up to 8 digits).

Menu	Description
Check/Reset/Print Copy Counter	<p>You can check or print the number of copies made under each user code. You can also reset each user code's counter to 0.</p> <p>If more than 10 user codes are registered, you can view all the counters using the [▲P-rev.] or [▼Next] key.</p>
Print	<p>You can print the copied quantity of the counter for each user code.</p> <p>To start the printing, press the [Start] key.</p> <p>To stop the printing, press the [Cancel] key.</p>
Reset Counter	You can reset each user code's counter to 0.
Reset All	You can reset all counters to 0.
User Code Register/Change/Delete	<p>You can register, change, or delete the user codes (8 digits or less).</p> <p> Note</p> <ul style="list-style-type: none"> <input type="checkbox"/> Up to 500 user codes can be registered. <input type="checkbox"/> Even if you have changed the user code, the counter value will not be cleared. <input type="checkbox"/> When the user code is deleted, the counter value will be automatically deleted.
Register	You can register the user codes.
Change	<p>You can change the user codes.</p> <p> Note</p> <ul style="list-style-type: none"> <input type="checkbox"/> The number of copies made under the old code is added to that made under the new user code.
Delete User Code	You can delete the user codes.
Delete All User Codes	You can delete all the user codes.

Menu	Description
Face-Up/Down Selection in Bypass Mode	<p>You can set whether copies are delivered face up or face down when making copies from the bypass tray.</p> <p> Limitation</p> <ul style="list-style-type: none"> <input type="checkbox"/> Only use “Face Down Exit” when copying onto standard high quality paper with a weight of 52 – 105g/m² (14 – 28 lb. Bond). <input type="checkbox"/> When you select “OHP” or “Thick Paper”, copy paper is delivered face up even if you have set the “Face-Up/Down Selection in Bypass Mode” setting to “Face Down Exit”. <p> Note</p> <ul style="list-style-type: none"> <input type="checkbox"/> Default: <i>Face Up Exit</i>
Connect Copy Master	<p>You can select whether the [Connect] key is displayed or not. If you choose “No”, the [Connect] key will not be displayed and this unit cannot become the master unit. As a default setting, “Yes” is selected. You can cancel this setting.</p> <p> Note</p> <ul style="list-style-type: none"> <input type="checkbox"/> Default : <i>Yes</i>
Auto File Delete	<p>Old files stored on the Document Server can be deleted automatically. The time can be set from 1 to 180 days, or 0.</p> <p> Note</p> <ul style="list-style-type: none"> <input type="checkbox"/> Default: <i>1 Days</i> <input type="checkbox"/> To turn “Auto File Delete” off, input “0”.
Delete All The Saved Files	<p>You can delete all the saved documents by pressing the [Delete All The Saved Files] key, and the [Yes] key in the confirmation dialog box.</p> <p> Note</p> <ul style="list-style-type: none"> <input type="checkbox"/> All the documents including those with a password are deleted.

Do's And Don'ts

CAUTION:

- *Unplug the power cord from the wall outlet before you move the equipment. While moving the equipment, you should take care that the power cord will not be damaged under the equipment.*
- When you use this equipment for a long time in a confined space without good ventilation, you may detect an odd smell. To keep the workplace comfortable, we recommend you keep it well ventilated.
- Do not press areas on or around the fusing unit. These areas get hot.
- After making copies continuously, the exposure glass may feel warm—this is not a malfunction.
- You might feel warm around the ventilation hole. This is caused by exhaust air, and is not a malfunction.
- Do not turn off the operation switch while copying or printing. Make sure that all copying or printing has finished.
- The machine might fail to produce good copy images if condensation forms inside the machine due to rapid temperature change. To prevent this problem, the machine has an anti-condensation function. Even after the main power switch is in the stand-by position, the anti-condensation heater is active, thus keeping the machine body slightly warm.
- Do not open the covers of machine while copying or printing. If you do, mis-feeds might occur.
- Do not move the machine while copying or printing.
- If you operate the machine improperly or a failure occurs on the machine, your machine settings might be lost. Be sure to take a note of your machine settings.
- Supplier shall not be liable for any loss or damages resulting from a failure on the machine, loss of machine settings, and use of the machine.
- Depending on the operating conditions (e.g., low temperature, input voltage), the copying speed might be reduced to produce a good copy image.

Where to Put Your Machine

Machine Environment

Your machine's location should be carefully chosen because environmental conditions greatly affect its performance.

Optimum environmental conditions

⚠ CAUTION:

- *Keep the equipment away from humidity and dust. Otherwise a fire or an electric shock might occur.*
- *Do not place the equipment on an unstable or tilted surface. If it topples over, it could cause injury.*

⚠ CAUTION:

- *If you use the equipment in a confined space, make sure there is a continuous air turnover.*

- Temperature: 10 – 32°C (50 – 89.6°F)(humidity to be 54% at 32°C, 89.6°F)
- Humidity: 15 – 80% (temperature to be 27°C, 80.6°F at 80%)
- A strong and level base.
- The machine must be level within 5mm, 0.2" both front to rear and left to right.
- To avoid possible buildup of ozone, be sure to locate this machine in a large well ventilated room that has an air turnover of more than 30 m³/hr/person.

Environments to avoid

- Locations exposed to direct sunlight or strong light (more than 1,500 lux).
- Locations directly exposed to cool air from an air conditioner or heated air from a heater. (Sudden temperature changes might cause condensation within the machine.)
- Locations close to such machines generating ammonia as diazo copy machine.
- Places where the machine might be subjected to frequent strong vibration.
- Dusty areas.
- Areas with corrosive gases.

Power Connection

⚠ WARNING:

- ***Only connect the machine to the power source described on the inside front cover of this manual. Connect the power cord directly into a wall outlet and do not use an extension cord.***
- ***Do not damage, break or make any modifications to the power cord. Do not place heavy objects on it. Do not pull it hard nor bend it more than necessary. These actions could cause an electric shock or fire.***

⚠ CAUTION:

- *Unplug the power cord from the wall outlet before you move the equipment. While moving the equipment, you should take care that the power cord will not be damaged under the equipment.*

⚠ CAUTION:

- *When you disconnect the power plug from the wall outlet, always pull the plug (not the cable).*
- When the main switch is in the Stand-by positions, the optional anti-condensation heaters are on. In case of emergency, unplug the machine's power cord.
- When you unplug the power cord, the anti-condensation heaters turn off.
- Make sure that the plug is firmly inserted in the outlet.
- Voltage must not fluctuate more than 10%.
- The socket-outlet shall be installed near the equipment and shall be easily accessible.

Access to the Machine

Place the machine near the power source, providing clearance as shown.

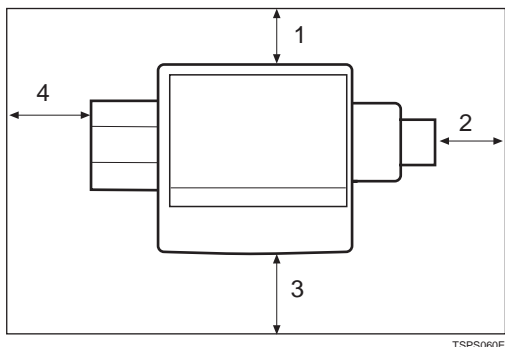

TSPS060E

1. Rear: more than 3 cm (1.2")
2. Right: more than 4 cm (1.6")
3. Front: more than 70 cm (27.6")
4. Left: more than 10 cm (4.0")

 **Note**

- For the required space when options are installed, contact your service representative.

Maintaining Your Machine

If the exposure glass or document feeder belt is dirty, you might not be able to make copies as you want. Clean them if you find them dirty.

❖ Cleaning the machine

Wipe the machine with a soft, damp cloth. Then, wipe it with a dry cloth to remove the water.

⚠ Important

- ❑ Do not use chemical cleaner or organic solvent, such as thinner or benzene. If they get into the machine or melt plastic parts, a failure might occur.
- ❑ Do not clean parts other than those specified in this manual. Such parts should be cleaned by your service representative.

Cleaning the Exposure Glass

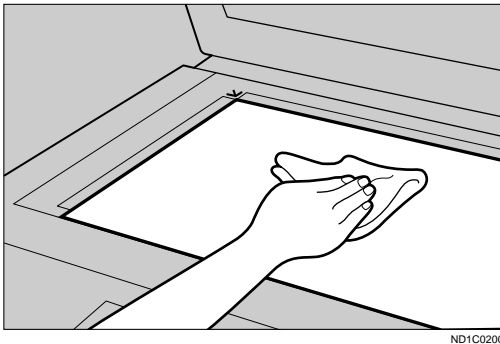

Cleaning the Document Feeder

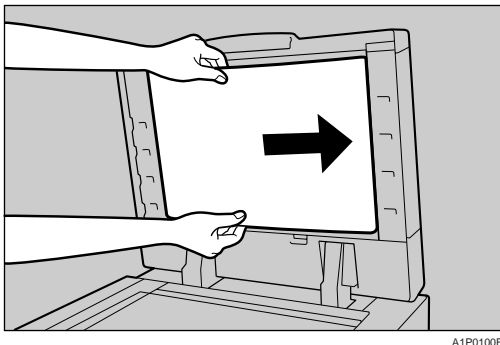

8. Specification

Mainframe

- ❖ **Configuration:**
Console
- ❖ **Photosensitivity type:**
OPC drum ($\Phi 100$)
- ❖ **Original scanning:**
One-dimensional solid scanning system through CCD
- ❖ **Copy process:**
Dry electrostatic transfer system
- ❖ **Development:**
Dry two-component magnetic brush development system
- ❖ **Fusing:**
Heating roll pressure system
- ❖ **Resolution:**
600 dpi
- ❖ **Exposure glass:**
Stationary original exposure type
- ❖ **Original reference position:**
Rear left corner
- ❖ **Warm-up time:**
Less than 330 seconds (23°C)
- ❖ **Originals:**
Sheet/book/objects
- ❖ **Maximum original size:**
A3☐, 11" × 17"☐
- ❖ **Copy paper size:**
 - Trays: A3☐ – A5☐, 11" × 17"☐ – 5¹/₂" × 8¹/₂"☐
 - Bypass: A3☐ – A6☐, 11" × 17"☐ – 5¹/₂" × 8¹/₂"☐
 - Bypass (non-standard size):
Vertical: 100 – 300mm, 4.0" – 11.7"
Horizontal: 140 – 432mm, 5.6" – 17.0"

- Duplex: A3☐ – A5☐, 11" × 17"☐ – 5¹/₂" × 8¹/₂"☐ (impossible on A5☐, 5¹/₂" × 8¹/₂" ☐)
 - LCT: A4☐, B5☐, 8¹/₂" × 14"☐ *¹, 8¹/₂" × 11"☐
- *¹ The optional 8¹/₂" × 14" paper size tray is required to set this size of paper.

❖ **Copy paper weight:**

- Paper tray: 52 – 128g/m², 14 – 34 lb. Bond
- Bypass tray: 52 – 157g/m², 14 lb. Bond – 90 lb. Index
52 – 200g/m², 14 lb. Bond – 110 lb. Index
(When the optional 100 sheet finisher is installed.)

❖ **Non-reproduction area:**

- Leading edge: Less than 3 ± 2mm
- Trailing edge: More than 1mm
- Left edge: More than 2 ± 1.5mm
- Right edge: More than 0.5mm

❖ **First copy time:**

- 3.5 seconds or less
(face up feed, A4☐, 8¹/₂" × 11"☐, 100%, feeding from tray 1, on the exposure glass, Text·Photo mode, Auto Image Density)
- 5.3 seconds or less
(face down feed, A4☐, 8¹/₂" × 11"☐, 100%, feeding from tray 1, on the exposure glass, Text·Photo mode, Auto Image Density)

❖ **Copying speed: (Type 1)**

- 28 copies/minute (A3☐, 11" × 17"☐)
- 55 copies/minute (A4☐, 8¹/₂" × 11"☐)

❖ **Copying speed: (Type 2)**

- 36 copies/minute (A3☐, 11" × 17"☐)
- 70 copies/minute (A4☐, 8¹/₂" × 11"☐)

❖ **Reproduction ratio:**

Preset reproduction ratios:

	Metric version	Inch version
Enlargement	400%	400%
	200%	200%
	141%	155%
	122%	129%
	115%	121%
Full Size	100%	100%

Reduction	93%	93%
	82%	85%
	75%	78%
	71%	73%
	65%	65%
	50%	50%

Zoom: From 25 to 400% in 1% steps.

❖ **Maximum continuous copy run:**

999 sets

❖ **Copy paper capacity:**

- Tray 1 (Tandem tray) : 3,100 sheets (1,550 sheets × 2) (80g/m², 20 lb. Bond)
- Tray 2 (550-sheet tray) : 550 sheets (80g/m², 20 lb. Bond)
- Tray 3 (550-sheet tray) : 550 sheets (80g/m², 20 lb. Bond)
- Bypass tray: 50 sheets (80g/m², 20 lb. Bond)

❖ **Power consumption:**

- Mainframe only

	Type 1	Type 2
Warm-up	about 1.29 kw	about 1.29 kw
Stand-by	about 0.25 kw	about 0.25 kw
During printing	about 1.6 kw	about 1.6 kw
Maximum	less than 1.75 kw	less than 1.75 kw

- Complete system ^{*1}

	Type 1	Type 2
Warm-up	about 1.29 kw	about 1.29 kw
Stand-by	about 0.26 kw	about 0.26 kw
During printing	about 1.6 kw	about 1.6 kw
Maximum	less than 1.75 kw	less than 1.75 kw

^{*1} The Complete System consists of the mainframe, finisher and large capacity tray (LCT).

❖ **Dimensions (W × D × H up to exposure glass):**

690 × 750 × 1,138mm, 27.2" × 29.6" × 44.9"

❖ **Space for mainframe (W × D):**

- 1,265 × 750mm, 49.9" × 29.6" (ADF external extender is not used. Optional Output tray is installed.)
- 1,380 × 750mm, 54" × 30" (ADF external extender is used for larger size originals. Optional Output tray is installed.)

❖ **Noise Emission *1 :**

Sound Power Level:

- Mainframe only

	Type 1	Type 2
Stand-by	Less than 49 dB (A)	Less than 49 dB (A)
During printing (ADF 1 to 1)	Less than 74 dB (A)	Less than 75 dB (A)
Copying (From Memory)	Less than 71 dB (A)	Less than 71 dB (A)

- Complete system *3

	Type 1	Type 2
Stand-by	Less than 49 dB (A)	Less than 49 dB (A)
During printing (ADF 1 to 1)	Less than 73 dB (A)	Less than 75 dB (A)
During printing(From Memory)	Less than 70 dB (A)	Less than 71 dB (A)

Sound Pressure Level *2:

- Mainframe only

	Type 1	Type 2
Stand-by	Less than 35 dB (A)	Less than 35 dB (A)
During printing (ADF 1 to 1)	Less than 62 dB (A)	Less than 65 dB (A)
During printing (From Memory)	Less than 57 dB (A)	Less than 58 dB (A)

- Complete system *3

	Type 1	Type 2
Stand-by	Less than 35 dB (A)	Less than 35 dB (A)
During printing (ADF 1 to 1)	Less than 62 dB (A)	Less than 65 dB (A)
During printing (From Memory)	Less than 56 dB (A)	Less than 58 dB (A)

*1 The above measurements made in accordance with ISO 7779 are actual value.

*2 It is measured at the position of the bystander.

*3 The Complete System consists of the mainframe, finisher and large capacity tray (LCT).

❖ **Weight:**







Type 1, 2: Approx. 188 kg, 414.5 lb (Mainframe with document feeder)

Document Feeder

❖ Mode:

ADF mode, Batch (SADF) mode, Mixed Sizes mode, Thin mode

❖ Original size:

- A3  – B6  
- 11" × 17"  – 5¹/₂" × 8¹/₂"  

❖ Original weight:

- 1-sided originals: 52 – 157g/m² (14 – 42 lb. Bond)
- 2-sided originals: 52 – 128g/m² (14 – 34 lb. Bond) (Duplex)
- Thin original: 41 – 157g/m² (11 – 42 lb. Bond)

❖ Number of originals to be set:

100 sheets (80g/m², 20 lb. Bond) or less than 12mm, 0.4"

Note

- Specifications are subject to change without notice.

50-Sheet Finisher

❖ Paper size:

Proof Tray: A3☐ – B6☐, A6☐, 11" × 17"☐ – 5¹/₂" × 8¹/₂"☐☐

Shift Tray: A3☐ – A5☐☐, 11" × 17"☐ – 5¹/₂" × 8¹/₂"☐☐

Staple Mode: A3☐ – B5☐☐, 11" × 17"☐ – 8¹/₂" × 11"☐☐

Punch Mode:

- 2 holes: A3☐ – A5☐☐, 11" × 17"☐, 8¹/₂" × 14"☐ – 5¹/₂" × 8¹/₂"☐☐
- 3 holes: A3☐, B4☐, A4☐, B5☐, 11" × 17"☐, 8¹/₂" × 11"☐
- 4 holes:
 - Metric version: A3☐, A4☐, 11" × 17"☐, 8¹/₂" × 11"☐
 - Scandinavian version: A3☐ – A5☐, 11" × 17"☐, 8¹/₂" × 14"☐ – 5¹/₂" × 8¹/₂"☐

❖ Paper weight:

Stack: 52 – 157g/m², 14 – 42 lb. Bond

Staple: 64 – 80g/m², 17 – 20 lb. Bond

Punch:

- 4 holes: 52 – 128g/m², 14 – 34 lb. Bond
- 2 or 3 holes: 52 – 157g/m², 14 lb. Bond – 90 lb. Index

❖ Stack capacity:

Proof Tray (without Punch):

- 250 sheets (A4, 8¹/₂" × 11" or smaller) (80g/m², 20 lb. Bond)
- 50 sheets (B4, 8¹/₂" × 14" or larger) (80g/m², 20 lb. Bond)

Proof Tray (with Punch):

- 200 sheets (A4, 8¹/₂" × 11" or smaller) (80g/m², 20 lb. Bond)
- 50 sheets (B4, 8¹/₂" × 14" or larger) (80g/m², 20 lb. Bond)

Shift Tray (without Punch):

- 3,000 sheets (A4☐, 8¹/₂" × 11"☐) (80g/m², 20 lb. Bond)
- 1,500 sheets (except A4☐, A5☐) (80g/m², 20 lb. Bond)
- 100 sheets (A5☐) (80g/m², 20 lb. Bond)

Shift Tray (with Punch):

- 2,500 sheets (A4☐, 8¹/₂" × 11"☐) (80g/m², 20 lb. Bond)
- 1,500 sheets (except A4☐, A5☐) (80g/m², 20 lb. Bond)
- 100 sheets (A5☐) (80g/m², 20 lb. Bond)

❖ Staple capacity:

Without Punch:

- 2 – 50 sheets (A4, 8¹/₂" × 11" or smaller) (80g/m², 20 lb. Bond)
- 2 – 30 sheets (B4, 8¹/₂" × 14" or larger) (80g/m², 20 lb. Bond)

With Punch:

- 2 – 40 sheets (A4, 8¹/₂" × 11" or smaller) (80g/m², 20 lb. Bond)
- 2 – 25 sheets (B4, 8¹/₂" × 14" or larger) (80g/m², 20 lb. Bond)

❖ Staple position:

Four positions (Top, Top Slant, Bottom, 2 Staples)

❖ Power consumption:

48W (power is supplied from the mainframe.)

❖ Dimensions (W × D × H):

625 × 545 × 960mm, 24.7" × 21.5" × 37.8"

❖ Weight:







Approx. 45kg, 99.3 lb







 Note







Specifications are subject to change without notice.

100-Sheet Finisher































❖ Paper size:

Proof Tray: A3  – A5  , 11" × 17"   – 5¹/₂" × 8¹/₂"  

Shift Tray: A3  – A5  , 11" × 17"   – 5¹/₂" × 8¹/₂"  

Staple Mode: A3  – B5  , 11" × 17"  – 8¹/₂" × 11"  

Punch Mode:

- 2 holes: A3  – A5  , 11" × 17"  , 8¹/₂" × 14"  – 5¹/₂" × 8¹/₂"  
- 3 holes: A3  , B4 , A4 , B5 , 11" × 17"  , 8¹/₂" × 11"  
- 4 holes:
 - Metric version: A3 , A4 , 11" × 17"  , 8¹/₂" × 11"  
 - Scandinavian version: A3  – A5 , 11" × 17"  , 8¹/₂" × 14"   – 5¹/₂" × 8¹/₂"  

❖ Paper weight:

Stack: 52 – 216g/m², 14 lb. Bond – 80 lb. Covers

Staple: 64 – 80g/m², 17 – 20 lb. Bond

Punch:





- 4 holes: 52 – 128g/m², 14 – 34 lb. Bond
- 2 or 3 holes: 52 – 157g/m², 14 lb. Bond – 90 lb. Index

❖ Stack capacity:



Proof Tray:

- 500 sheets (A4, 8¹/₂" × 11" or smaller) (80g/m², 20 lb. Bond)
- 250 sheets (B4, 8¹/₂" × 14" or larger) (80g/m², 20 lb. Bond)

Shift Tray (without Punch):

- 3,000 sheets (A4 , 8¹/₂" × 11" ) (80g/m², 20 lb. Bond)
- 1,500 sheets (except A4 , A5 ) (80g/m², 20 lb. Bond)
- 100 sheets (A5 ) (80g/m², 20 lb. Bond)



Shift Tray (with Punch):

- 2,500 sheets (A4 , 8¹/₂" × 11" ) (80g/m², 20 lb. Bond)
- 1,500 sheets (Others) (80g/m², 20 lb. Bond)

Shift Tray (with Staple):

- 10 – 100 originals = 200 – 30 sets (A4, 8¹/₂" × 5¹/₂") (80g/m², 20 lb. Bond)
- 1,500 sheets (B4, 8¹/₂" × 14" or larger) (80g/m², 20 lb. Bond)

❖ Staple capacity:

- 2 – 100 sheets (A4 , B5 , 8¹/₂" × 11" ) (80g/m², 20 lb. Bond)
- 2 – 50 sheets (Others) (80g/m², 20 lb. Bond)

❖ Staple position:

Five positions (Top, Top Slant, Bottom, Left 2, Top 2)

❖ Power consumption:

140W (power is supplied from the mainframe.)

❖ Dimensions (W × D × H):

800 × 728 × 980mm, 31.5" × 28.7" × 38.6"

❖ Weight:







Approx. 50kg, 130.1 lb







 Note

- Specifications are subject to change without notice.





Booklet Finisher



❖ Paper size:





Proof Tray: A3  – A5  , 11" × 17"  – 5¹/₂" × 8¹/₂"  

Shift Tray: A3  – A5  , 11" × 17"  – 5¹/₂" × 8¹/₂"  

Staple Mode:

- Bottom or Top: A3  – B5 , 11" × 17" , 8¹/₂" × 11"  

- 2 Staples: A3 , B4 , A4 , B5 , 11" × 17" , 8¹/₂" × 11"  

Saddle Stitch Mode: A3  – A4 , 11" × 17" , 8¹/₂" × 11"  

❖ Paper weight:

Stack: 52 – 163g/m², 14 – 42 lb. Bond

Staple: 64 – 80g/m², 17 – 20 lb. Bond

Saddle Stitch:



- 64 – 80g/m², 17 – 20 lb. Bond

- 64 – 128g/m², 14 – 34 lb. Cover (up to 1 cover sheet can be stapled.)



❖ Stack capacity:

Proof Tray:

- 150 sheets (A4 , 8¹/₂" × 11"  or smaller) (80g/m², 20 lb. Bond)



- 75 sheets (A4 , 8¹/₂" × 11"  or larger) (80g/m², 20 lb. Bond)

Shift Tray (without Staple):

- 1,000 sheets (A4 , 8¹/₂" × 11" ) (80g/m², 20 lb. Bond)

- 500 sheets (A4 , 8¹/₂" × 11"  or larger) (80g/m², 20 lb. Bond)

Shift Tray (with Staple):

- 750 sheets (A4 , 8¹/₂" × 11" ) (80g/m², 20 lb. Bond)

- 500 sheets (A4 , 8¹/₂" × 11"  or larger) (80g/m², 20 lb. Bond)

Booklet Tray:

- 25 sets (1 – 5 sheets, 80g/m², 20 lb. Bond)

- 15 sets (6 – 10 sheets, 80g/m², 20 lb. Bond)

- 10 sets (11 – 15 sheets, 80g/m², 20 lb. Bond)

❖ Staple capacity:

Staple Mode:

- 2 – 50 sheets (A4 , 8¹/₂" × 11"  or smaller) (80g/m², 20 lb. Bond)

- 2 – 30 sheets (A4 , 8¹/₂" × 11"  or larger) (80g/m², 20 lb. Bond)

Saddle Stitch Mode: 2 – 15 sheets (80g/m², 20 lb. Bond)

❖ Staple position:

Staple Mode: Five positions (Top, Top Slant, Bottom, Left 2, Top 2)

Saddle Stitch Mode: One position

❖ Folding:

Center folding

❖ Power consumption:

60W (power is supplied from the mainframe.)

❖ Dimensions (W × D × H):

689 × 603 × 1,055mm, 27.2" × 23.8" × 41.6"

❖ Weight:























Approx. 50kg, 130.1 lb

 Note

- Specifications are subject to change without notice.

Punch Kit (Option)

❖ Paper size

- 2 holes: A3  – A5  , 11" × 17" , 8¹/₂" × 14"  – 5¹/₂" × 8¹/₂"  
- 3 holes: A3 , B4 , A4 , B5 , 11" × 17" , 8¹/₂" × 11" 
- 4 holes:
 - Metric version: A3 , A4 , 11" × 17" , 8¹/₂" × 11" 
 - Scandinavian version: A3  – A5 , 11" × 17" , 8¹/₂" × 14"  – 5¹/₂" × 8¹/₂" 

❖ Paper weight:

- 4 holes: 52 – 128g/m², 14 – 34 lb. Bond
- 2 or 3 holes: 52 – 157g/m², 14 lb. Bond – 90 lb. Index

❖ Power consumption:

33.6 W (power is supplied from the mainframe.)

❖ Dimensions (W × D × H):

92 × 463 × 100mm, 3.7" × 18.3" × 4.0"

❖ Weight:

Approx. 2.4 kg, 5.3 lb

Note

- ❑ Specifications are subject to change without notice.

Output Tray (Option)

❖ Paper capacity:

- A3, 11" × 17" : 250 sheets
- B4, 8¹/₂" × 14" : 500 sheets
- A4, 8¹/₂" × 11" : 500 sheets
- B5, 5¹/₂" × 8¹/₂" : 250 sheets

❖ Dimensions (W × D × H):

390 × 330 × 130mm, 15.4" × 13.0" × 5.2"

❖ Weight:

Approx. 650 g, 1.5 lb

Note

- Specifications are subject to change without notice.

Large Capacity Tray (LCT) (Option)

❖ **Paper size:**

A4 □, B5 □, 8¹/₂" × 14" □ *1, 8¹/₂" × 11" □

*1 The optional 8¹/₂" × 14" paper size tray is required to set this size of paper.

❖ **Paper weight:**

64 – 105g/m², 16 – 24 lb. Bond

❖ **Paper capacity:**

3,500 sheets (80g/m², 20 lb. Bond)

❖ **Power consumption**

Maximum. 48 W (power is supplied from the mainframe.)

❖ **Dimensions (W × D × H, option unit):**

403 × 529 × 608mm, 15.9" × 20.9" × 24.0"

❖ **Weight:**

Approx. 22 kg, 48.6 lb





 **Note**

□ Specifications are subject to change without notice.





Copy Connector Cable (Option)

❖ Continuous copying speed:





With two 55 copies/minute models:

- 110 copies/minute (A4 , 8¹/₂" × 11" )
- 58 copies/minute (A3 , 11" × 17" )

With two 70 copies/minute models:

- 140 copies/minute (A4 , 8¹/₂" × 11" )
- 72 copies/minute (A3 , 11" × 17" )

With one 55 copies/minute model and one 70 copies/minute model:

- 125 copies/minute (A4 , 8¹/₂" × 11" )
- 64 copies/minute (A3 , 11" × 17" )

❖ Dimensions (W × D × H):

310 × 310 × 65mm, 12.2" × 12.2" × 2.5"

❖ Weight:

Approx. 500g, 1.1 lb

❖ Length:

10m

INDEX

100-Sheet Finisher, 7, 346
50-Sheet Finisher, 7, 344

A

Access to the Machine, 336
Adding Staples, 285
ADF external tray, 4, 5
ADF tray, 5
Auto Off, 30, 235
Auto Reduce/Enlarge, 47
Auto Reset, 30, 234
Auto Start, 90

B

Back Cover, 151, 154
Background Numbering, 181
Basic functions, 40
Batch (SADF) mode, 36
Booklet Finisher, 7, 225, 348
Book originals, copying, 137, 140
Border Erase, 172, 173
Bypass tray, 5, 73

C

Center/Border Erase, 172, 177
Center Erase, 172, 175
Centering, 179
Changing Paper
 Tray 2, 282
Changing the Paper Size, 282
Changing the Toner Bottle, 268
Chapters, 158
Clearing Misfeeds, 270
Clear Modes/Energy Saver key, 8
Clear/Stop key, 9
Combination Chart, 206
Combine, 107, 115
Connect Copy, 223, 225, 230, 353
 Document Server, 226
 Exiting, 235
 Interrupt, 226
 Relationship, 239
Connect Copy port, 5
Control Panel, 8
Control panel, 4

Copying
 Connect Copy, 223
Copy Paper, 23, 43
Cover
 Back Cover, 151, 154
 Front Cover, 151, 154

D

Date Stamp, 194
Designate, 156
Directional Magnification (%), 101
Directional Size Magnification (inch), 104
Display, 10
Display Panel, 227
Display panel, 8, 10
Document Feeder, 343
Document feeder, 4, 32, 232
 Cleaning, 337
Document Server, 209
 Deleting, 220
 Features and Benefits, 210
 Printing, 216
 Scanning Originals, 212
Do's And Don'ts, 333
Double Copies, 165

E

Energy Saver mode, 88
Enlarging, 94
Environment, 334
Erase
 Border, 172, 173
 Center, 172, 175
 Center/Border, 172, 177
Exposure glass, 4, 19, 31
 Cleaning, 337
Extender, 74

F

File Merge Printing, 211
Finisher, 225
 100-Sheet Finisher, 7
 50-Sheet Finisher, 7
 Booklet Finisher, 7
Front Cover, 151, 154
Front cover, 4
Function indicators, 9
Function Status indicator, 9

I

Image Density, 40, 41
Image Repeat, 167
Indicators, 8
Interrupt Copy, 88
Interrupt key, 8

J

Job Preset, 83

L

Large Capacity Tray (LCT), 7, 352
Loading Paper, 263
 Large Capacity Tray (LCT), 266
 Tray 1, 263
 Tray 2, 265
 Tray 3, 265

M

Machine Environment, 334
Mainframe, 339
Main power indicator, 8
Main power switch, 4, 17
Maintenance, 337
Margin Adjustment, 170
Master unit, 225
Messages, 247
Misfeeds, 270
Mixed Sizes mode, 37

N

Numbering
 Background Numbering, 181
 Page Numbering, 198
Number keys, 9

O

On Demand Printing, 210
On indicator, 4, 8
Operation switch, 4, 8, 17
Options, 7
Original Beeper, 91
Original Mode Quality Level, 226
Originals, 19, 231
Originals, setting, 31
Original Type, selecting, 42
Output Tray, 351
Output tray, 4, 7
Output tray guide, 4, 6

P

Page Numbering, 198
Paper
 Changing, 282
 Loading, 263
Paper tray, 4
Power Connection, 335
Preset Stamp, 183
Program
 Changing, 80
 Deleting, 80
 Recalling, 81
 Storing, 78
Program key, 8
Programs, 78
Punching copies, 69
Punch kit, 350

R

Reduce/Enlarge, 94
Reducing, 94
Remarks, 333
Removing Jammed Staples, 293
Removing Punch Waste, 301
Repeat
 Image Repeat, 167

S

Safety information, i
Sample Copy, 91
Sample Copy key, 8
Screen Contrast knob, 8
Series Copies, 137, 138
Slip Sheets, 151, 162
Sort, 52
Sorting copies into sets, 55
Specification, 339
 100-Sheet Finisher, 346
 50-Sheet Finisher, 344
 Booklet Finisher, 348
 Connect Copy, 353
 Document Feeder, 343
 Large Capacity Tray (LCT), 352
 Mainframe, 339
 Output Tray, 351
 Punch kit, 350
Stack, 52, 58

Stamp, 181
 Background Numbering, 181
 Date Stamp, 194
 Page Numbering, 198
 Preset Stamp, 183
 User Stamp, 186
Staple, 52
Staples, 285
 Removing Jammed Staples, 293
Stapling copies, 60
Start key, 9
Sub-unit, 225

T

Thin mode, 39
Toner, 27
Toner Bottle
 Changing, 268
 Storage, 27
Two-sided Copies, 107, 111

U

User Codes, 90
User Stamp, 186
User Tools
 Copy/Document Server Features, 305
 Settings, 310
User Tools/Counter key, 8

V

Ventilation hole, 6

Z

Zoom, 97